

# PILOT'S OPERATING HANDBOOK

**Cessna**®

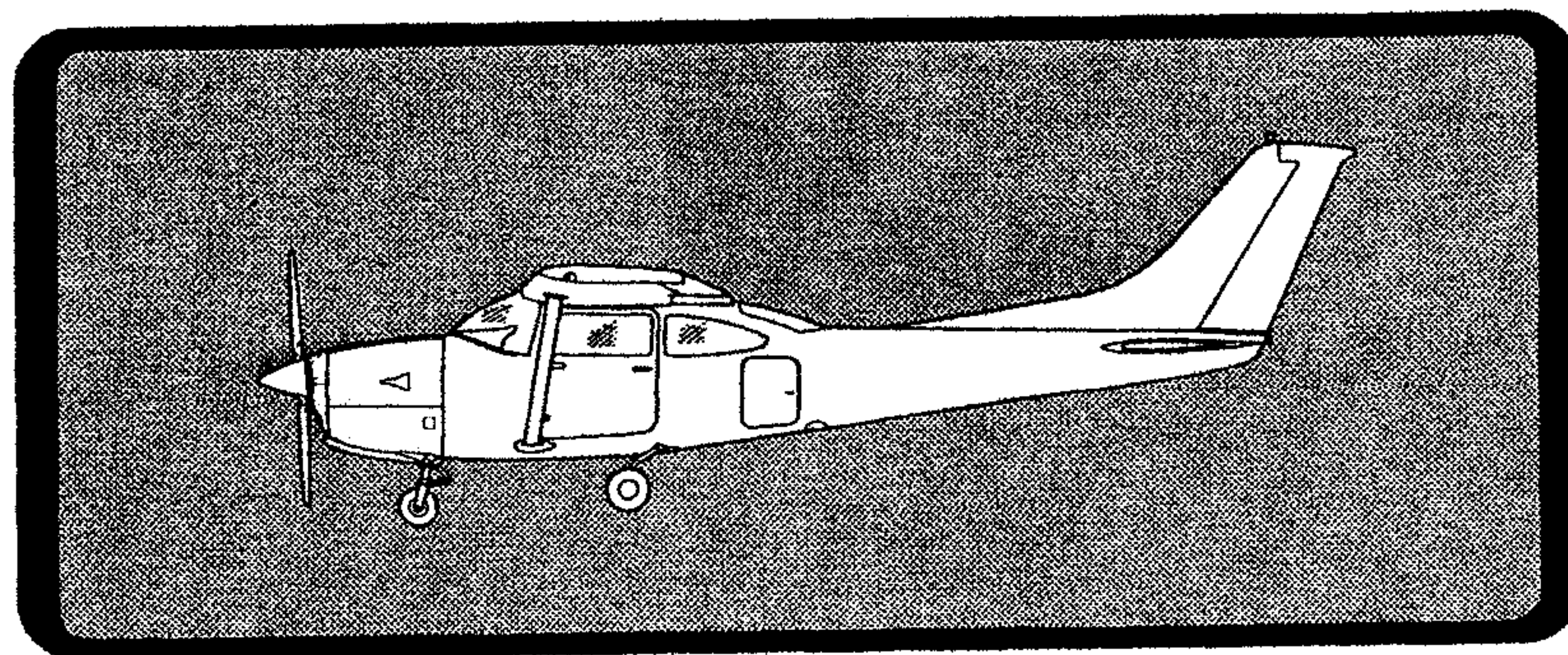

## SKYLANE RG

1978 MODEL R182

Serial No. \_\_\_\_\_

Registration No. \_\_\_\_\_

THIS HANDBOOK INCLUDES THE MATERIAL REQUIRED  
TO BE FURNISHED TO THE PILOT BY CAR PART 3

COPYRIGHT © 1977

CESSNA AIRCRAFT COMPANY

WICHITA, KANSAS, USA

Handwritten text, possibly bleed-through from the reverse side of the page. The text is extremely faint and illegible.

# CONGRATULATIONS . . . .

Welcome to the ranks of Cessna owners! Your Cessna has been designed and constructed to give you the most in performance, economy, and comfort. It is our desire that you will find flying it, either for business or pleasure, a pleasant and profitable experience.

This Pilot's Operating Handbook has been prepared as a guide to help you get the most pleasure and utility from your airplane. It contains information about your Cessna's equipment, operating procedures, and performance; and suggestions for its servicing and care. We urge you to read it from cover to cover, and to refer to it frequently.

Our interest in your flying pleasure has not ceased with your purchase of a Cessna. World-wide, the Cessna Dealer Organization backed by the Cessna Customer Services Department stands ready to serve you. The following services are offered by most Cessna Dealers:

- THE CESSNA WARRANTY, which provides coverage for parts and labor, is available at Cessna Dealers worldwide. Specific benefits and provisions of warranty, plus other important benefits for you, are contained in your Customer Care Program book, supplied with your airplane. Warranty service is available to you at authorized Cessna Dealers throughout the world upon presentation of your Customer Care Card which establishes your eligibility under the warranty.
- FACTORY TRAINED PERSONNEL to provide you with courteous expert service.
- FACTORY APPROVED SERVICE EQUIPMENT to provide you efficient and accurate workmanship.
- A STOCK OF GENUINE CESSNA SERVICE PARTS on hand when you need them.
- THE LATEST AUTHORITATIVE INFORMATION FOR SERVICING CESSNA AIRPLANES, since Cessna Dealers have all of the Service Manuals and Parts Catalogs, kept current by Service Letters and Service News Letters, published by Cessna Aircraft Company.

We urge all Cessna owners to use the Cessna Dealer Organization to the fullest.

A current Cessna Dealer Directory accompanies your new airplane. The Directory is revised frequently, and a current copy can be obtained from your Cessna Dealer. Make your Directory one of your cross-country flight planning aids; a warm welcome awaits you at every Cessna Dealer.

## PERFORMANCE - SPECIFICATIONS

<b>SPEED:</b>	
Maximum at Sea Level . . . . .	160 KNOTS
Cruise, 75% Power at 7500 Ft . . . . .	156 KNOTS
<b>CRUISE:</b> Recommended lean mixture with fuel allowance for engine start, taxi, takeoff, climb and 45 minutes reserve at 45% power.	
75% Power at 7500 Ft . . . . .	Range 520 NM
56 Gallons Usable Fuel . . . . .	Time 3.4 HRS
75% Power at 7500 Ft . . . . .	Range 740 NM
75 Gallons Usable Fuel . . . . .	Time 4.8 HRS
Maximum Range at 10,000 Ft . . . . .	Range 655 NM
56 Gallons Usable Fuel . . . . .	Time 5.3 HRS
Maximum Range at 10,000 Ft . . . . .	Range 940 NM
75 Gallons Usable Fuel . . . . .	Time 7.5 HRS
<b>RATE OF CLIMB AT SEA LEVEL</b> . . . . .	1140 FPM
<b>SERVICE CEILING</b> . . . . .	14,300 FT*
<b>TAKEOFF PERFORMANCE:</b>	
Ground Roll . . . . .	820 FT
Total Distance Over 50-Ft Obstacle . . . . .	1570 FT
<b>LANDING PERFORMANCE:</b>	
Ground Roll . . . . .	600 FT
Total Distance Over 50-Ft Obstacle . . . . .	1320 FT
<b>STALL SPEED (CAS):</b>	
Flaps Up, Power Off . . . . .	54 KNOTS
Flaps Down, Power Off . . . . .	50 KNOTS
<b>MAXIMUM WEIGHT:</b>	
Ramp . . . . .	3112 LBS
Takeoff or Landing . . . . .	3100 LBS
<b>STANDARD EMPTY WEIGHT:</b>	
Skylane RG . . . . .	1734 LBS
Skylane RG II . . . . .	1794 LBS
<b>MAXIMUM USEFUL LOAD:</b>	
Skylane RG . . . . .	1378 LBS
Skylane RG II . . . . .	1318 LBS
<b>BAGGAGE ALLOWANCE</b> . . . . .	200 LBS
<b>WING LOADING: Pounds/Sq Ft</b> . . . . .	17.8
<b>POWER LOADING: Pounds/HP</b> . . . . .	13.2
<b>FUEL CAPACITY: Total</b>	
Standard Tanks . . . . .	61 GAL.
Long Range Tanks . . . . .	80 GAL.
<b>OIL CAPACITY</b> . . . . .	9 QTS
<b>ENGINE: Avco Lycoming</b> . . . . .	O-540-J3C5D
235 BHP at 2400 RPM	
<b>PROPELLER: Constant Speed, Diameter</b> . . . . .	82 IN.

\*The Service Ceiling is 18,000 ft if an optional EGT indicator is used to set the mixture.

# TABLE OF CONTENTS

	SECTION
GENERAL.....	1
LIMITATIONS.....	2
EMERGENCY PROCEDURES.....	3
NORMAL PROCEDURES.....	4
PERFORMANCE.....	5
WEIGHT & BALANCE/ EQUIPMENT LIST .....	6
AIRPLANE & SYSTEMS DESCRIPTIONS .....	7
AIRPLANE HANDLING, SERVICE & MAINTENANCE .....	8
SUPPLEMENTS (Optional Systems Description & Operating Procedures) .....	9



# SECTION 1 GENERAL

## TABLE OF CONTENTS

	Page
Three View . . . . .	1-2
Introduction . . . . .	1-3
Descriptive Data . . . . .	1-3
Engine . . . . .	1-3
Propeller . . . . .	1-3
Fuel . . . . .	1-3
Oil . . . . .	1-4
Maximum Certificated Weights . . . . .	1-5
Standard Airplane Weights . . . . .	1-5
Cabin And Entry Dimensions . . . . .	1-5
Baggage Space And Entry Dimensions . . . . .	1-5
Specific Loadings . . . . .	1-5
Symbols, Abbreviations And Terminology . . . . .	1-6
General Airspeed Terminology And Symbols . . . . .	1-6
Meteorological Terminology . . . . .	1-7
Engine Power Terminology . . . . .	1-7
Airplane Performance And Flight Planning Terminology . . . . .	1-7
Weight And Balance Terminology . . . . .	1-8

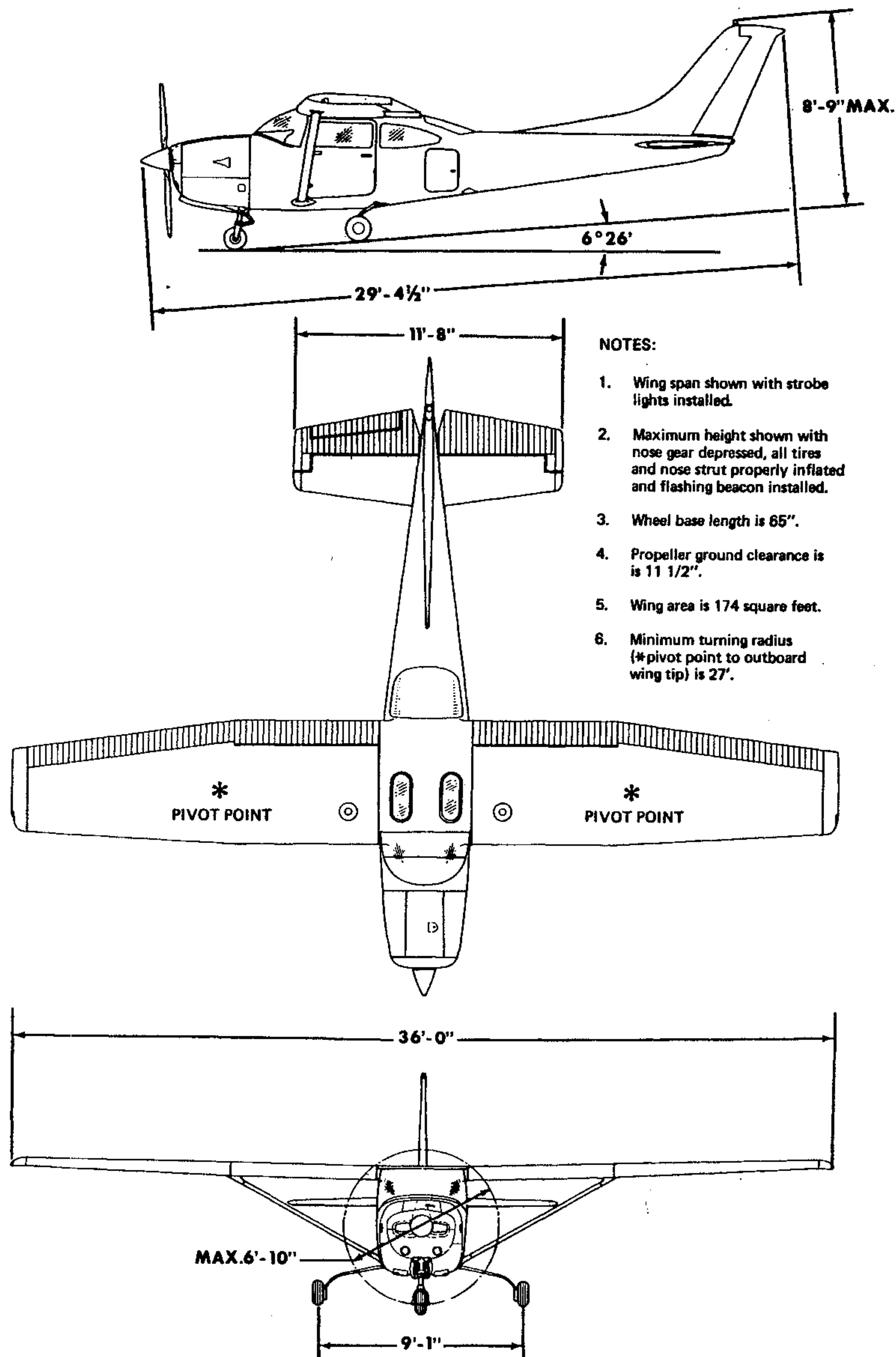

Figure 1-1. Three View



## INTRODUCTION

This handbook contains 9 sections, and includes the material required to be furnished to the pilot by CAR Part 3. It also contains supplemental data supplied by Cessna Aircraft Company.

Section 1 provides basic data and information of general interest. It also contains definitions or explanations of symbols, abbreviations, and terminology commonly used.

## DESCRIPTIVE DATA

### ENGINE

Number of Engines: 1.

Engine Manufacturer: Avco Lycoming.

Engine Model Number: O-540-J3C5D.

Engine Type: Normally-aspirated, direct-drive, air-cooled, horizontally-opposed, carburetor equipped, six-cylinder engine with 541.5 cu. in. displacement.

Horsepower Rating and Engine Speed: 235 rated BHP at 2400 RPM.

### PROPELLER

Propeller Manufacturer: McCauley Accessory Division.

Propeller Model Number: B2D34C214/90DHB-8.

Number of Blades: 2.

Propeller Diameter, Maximum: 82 inches.

Minimum: 80.5 inches.

Propeller Type: Constant speed and hydraulically actuated, with a low pitch setting of 15.8° and a high pitch setting of 29.4° (30 inch station).

### FUEL

Approved Fuel Grades (and Colors):

100LL Grade Aviation Fuel (Blue).

100 (Formerly 100/130) Grade Aviation Fuel (Green).

**Fuel Capacity:**

**Standard Tanks:**

Total Capacity: 61 gallons.

Total Capacity Each Tank: 30.5 gallons.

Total Usable: 56 gallons.

**Long Range Tanks:**

Total Capacity: 80 gallons.

Total Capacity Each Tank: 40 gallons.

Total Usable: 75 gallons.

**NOTE**

To ensure maximum fuel capacity when refueling, place the fuel selector valve in either LEFT or RIGHT position to prevent cross-feeding.

**OIL**

**Oil Grade (Specification):**

MIL-L-6082 Aviation Grade Straight Mineral Oil: Use to replenish supply during first 25 hours and at the first 25-hour oil change. Continue to use until a total of 50 hours has accumulated or oil consumption has stabilized.

**NOTE**

The airplane was delivered from the factory with a corrosion preventive aircraft engine oil. This oil should be drained after the first 25 hours of operation.

MIL-L-22851 Ashless Dispersant Oil: This oil must be used after first 50 hours or oil consumption has stabilized.

**Recommended Viscosity For Temperature Range:**

MIL-L-6082 Aviation Grade Straight Mineral Oil:

SAE 50 above 16°C (60°F).

SAE 40 between -1°C (30°F) and 32°C (90°F).

SAE 30 between -18°C (0°F) and 21°C (70°F).

SAE 20 below -12°C (10°F).

MIL-L-22851 Ashless Dispersant Oil:

SAE 40 or SAE 50 above 16°C (60°F).

SAE 40 between -1°C (30°F) and 32°C (90°F).

SAE 30 or SAE 40 between -18°C (0°F) and 21°C (70°F).

SAE 30 below -12°C (10°F).

**Oil Capacity:**

Sump: 8 Quarts.

Total: 9 Quarts.

## MAXIMUM CERTIFICATED WEIGHTS

Takeoff: 3100 lbs.

Landing: 3100 lbs.

Weight in Baggage Compartment:

Baggage Area "A" (or passenger on child's seat) - Station 82 to 110: 120 lbs. See note below.

Baggage Area "B" - Station 110 to 134: 80 lbs. See note below.

### NOTE

The maximum combined weight capacity for baggage areas A and B is 200 lbs.

## STANDARD AIRPLANE WEIGHTS

Standard Empty Weight, Skylane RG: 1734 lbs.

Skylane RG II: 1794 lbs.

Maximum Useful Load, Skylane RG: 1378 lbs.

Skylane RG II: 1318 lbs.

## CABIN AND ENTRY DIMENSIONS

Detailed dimensions of the cabin interior and entry door openings are illustrated in Section 6.

## BAGGAGE SPACE AND ENTRY DIMENSIONS

Dimensions of the baggage area and baggage door opening are illustrated in detail in Section 6.

## SPECIFIC LOADINGS

Wing Loading: 17.8 lbs./sq. ft.

Power Loading: 13.2 lbs./hp.

## SYMBOLS, ABBREVIATIONS AND TERMINOLOGY

### GENERAL AIRSPEED TERMINOLOGY AND SYMBOLS

KCAS	<b>Knots Calibrated Airspeed</b> is indicated airspeed corrected for position and instrument error and expressed in knots. Knots calibrated airspeed is equal to KTAS in standard atmosphere at sea level.
KIAS	<b>Knots Indicated Airspeed</b> is the speed shown on the airspeed indicator and expressed in knots.
KTAS	<b>Knots True Airspeed</b> is the airspeed expressed in knots relative to undisturbed air which is KCAS corrected for altitude and temperature.
$V_A$	<b>Maneuvering Speed</b> is the maximum speed at which you may use abrupt control travel.
$V_{FE}$	<b>Maximum Flap Extended Speed</b> is the highest speed permissible with wing flaps in a prescribed extended position.
$V_{LE}$	<b>Maximum Landing Gear Extended Speed</b> is the maximum speed at which an airplane can be safely flown with the landing gear extended.
$V_{LO}$	<b>Maximum Landing Gear Operating Speed</b> is the maximum speed at which the landing gear can be safely extended or retracted.
$V_{NO}$	<b>Maximum Structural Cruising Speed</b> is the speed that should not be exceeded except in smooth air, then only with caution.
$V_{NE}$	<b>Never Exceed Speed</b> is the speed limit that may not be exceeded at any time.
$V_S$	<b>Stalling Speed</b> or the minimum steady flight speed at which the airplane is controllable.
$V_{S_0}$	<b>Stalling Speed</b> or the minimum steady flight speed at which the airplane is controllable in the landing configuration at the most forward center of gravity.

$V_X$  **Best Angle-of-Climb Speed** is the speed which results in the greatest gain of altitude in a given horizontal distance.

$V_Y$  **Best Rate-of-Climb Speed** is the speed which results in the greatest gain in altitude in a given time.

### METEOROLOGICAL TERMINOLOGY

OAT **Outside Air Temperature** is the free air static temperature. It is expressed in either degrees Celsius (formerly Centigrade) or degrees Fahrenheit.

Standard Temperature **Standard Temperature** is 15°C at sea level pressure altitude and decreases by 2°C for each 1000 feet of altitude.

Pressure Altitude **Pressure Altitude** is the altitude read from an altimeter when the altimeter's barometric scale has been set to 29.92 inches of mercury (1013 mb).

### ENGINE POWER TERMINOLOGY

BHP **Brake Horsepower** is the power developed by the engine.

RPM **Revolutions Per Minute** is engine speed.

MP **Manifold Pressure** is a pressure measured in the engine's induction system and is expressed in inches of mercury (Hg).

### AIRPLANE PERFORMANCE AND FLIGHT PLANNING TERMINOLOGY

Demonstrated Crosswind Velocity **Demonstrated Crosswind Velocity** is the velocity of the crosswind component for which adequate control of the airplane during takeoff and landing was actually demonstrated during certification tests. The value shown is not considered to be limiting.

Usable Fuel **Usable Fuel** is the fuel available for flight planning.

Unusable Fuel **Unusable Fuel** is the quantity of fuel that can not be safely used in flight.

GPH **Gallons Per Hour** is the amount of fuel (in gallons) consumed per hour.

**NMPG**            **Nautical Miles Per Gallon** is the distance (in nautical miles) which can be expected per gallon of fuel consumed at a specific engine power setting and/or flight configuration.

**g**                **g** is acceleration due to gravity.

### WEIGHT AND BALANCE TERMINOLOGY

**Reference Datum**        **Reference Datum** is an imaginary vertical plane from which all horizontal distances are measured for balance purposes.

**Station**                **Station** is a location along the airplane fuselage given in terms of the distance from the reference datum.

**Arm**                    **Arm** is the horizontal distance from the reference datum to the center of gravity (C.G.) of an item.

**Moment**                **Moment** is the product of the weight of an item multiplied by its arm. (Moment divided by the constant 1000 is used in this handbook to simplify balance calculations by reducing the number of digits.)

**Center of Gravity (C.G.)**        **Center of Gravity** is the point at which an airplane, or equipment, would balance if suspended. Its distance from the reference datum is found by dividing the total moment by the total weight of the airplane.

**C.G. Arm**                **Center of Gravity Arm** is the arm obtained by adding the airplane's individual moments and dividing the sum by the total weight.

**C.G. Limits**            **Center of Gravity Limits** are the extreme center of gravity locations within which the airplane must be operated at a given weight.

**Standard Empty Weight**        **Standard Empty Weight** is the weight of a standard airplane, including unusable fuel, full operating fluids and full engine oil.

**Basic Empty Weight**        **Basic Empty Weight** is the standard empty weight plus the weight of optional equipment.

**Useful Load**            **Useful Load** is the difference between ramp weight and the basic empty weight.

Maximum Ramp Weight	<b>Maximum Ramp Weight</b> is the maximum weight approved for ground maneuver. (It includes the weight of start, taxi and runup fuel.)
Gross (Loaded) Weight	<b>Gross (Loaded) Weight</b> is the loaded weight of the airplane.
Maximum Takeoff Weight	<b>Maximum Takeoff Weight</b> is the maximum weight approved for the start of the takeoff run.
Maximum Landing Weight	<b>Maximum Landing Weight</b> is the maximum weight approved for the landing touchdown.
Tare	<b>Tare</b> is the weight of chocks, blocks, stands, etc. used when weighing an airplane, and is included in the scale readings. Tare is deducted from the scale reading to obtain the actual (net) airplane weight.





# SECTION 2 LIMITATIONS

## TABLE OF CONTENTS

	Page
Introduction . . . . .	2-3
Airspeed Limitations . . . . .	2-4
Airspeed Indicator Markings . . . . .	2-4
Power Plant Limitations . . . . .	2-5
Power Plant Instrument Markings . . . . .	2-6
Weight Limits . . . . .	2-6
Center Of Gravity Limits . . . . .	2-7
Maneuver Limits . . . . .	2-7
Flight Load Factor Limits . . . . .	2-7
Kinds Of Operation Limits . . . . .	2-7
Fuel Limitations . . . . .	2-8
Placards . . . . .	2-9



## INTRODUCTION

Section 2 includes operating limitations, instrument markings, and basic placards necessary for the safe operation of the airplane, its engine, standard systems and standard equipment. The limitations included in this section have been approved by the Federal Aviation Administration. When applicable, limitations associated with optional systems or equipment are included in Section 9.

### NOTE

The airspeeds listed in the Airspeed Limitations chart (figure 2-1) and the Airspeed Indicator Markings chart (figure 2-2) are based on Airspeed Calibration data shown in Section 5 with the normal static source, with the exception of the bottom of the green and white arcs on the airspeed indicator. These are based on a power-off airspeed calibration. If the alternate static source is being used, ample margins should be observed to allow for the airspeed calibration variations between the normal and alternate static sources as shown in Section 5.

Your Cessna is certificated under FAA Type Certificate No. 3A13 as Cessna Model No. R182.

## AIRSPEED LIMITATIONS

Airspeed limitations and their operational significance are shown in figure 2-1.

	SPEED	KCAS	KIAS	REMARKS
V <sub>NE</sub>	Never Exceed Speed	175	182	Do not exceed this speed in any operation.
V <sub>NO</sub>	Maximum Structural Cruising Speed	140	143	Do not exceed this speed except in smooth air, and then only with caution.
V <sub>A</sub>	Maneuvering Speed: 3100 Pounds 2550 Pounds 2000 Pounds	111 100 89	112 101 89	Do not make full or abrupt control movements above this speed.
V <sub>FE</sub>	Maximum Flap Extended Speed To 10° Flaps 10° - 40° Flaps	137 94	140 95	Do not exceed these speeds with the given flap settings.
V <sub>LO</sub>	Maximum Landing Gear Operating Speed	137	140	Do not extend or retract landing gear above this speed.
V <sub>LE</sub>	Maximum Landing Gear Extended Speed	137	140	Do not exceed this speed with landing gear extended
	Maximum Window Open Speed	175	182	Do not exceed this speed with windows open.

Figure 2-1. Airspeed Limitations

## AIRSPEED INDICATOR MARKINGS

Airspeed indicator markings and their color code significance are shown in figure 2-2.

MARKING	KIAS VALUE OR RANGE	SIGNIFICANCE
White Arc	37 - 95	Full Flap Operating Range. Lower limit is maximum weight $V_{SO}$ in landing configuration. Upper limit is maximum speed permissible with flaps extended.
Green Arc	42 - 143	Normal Operating Range. Lower limit is maximum weight $V_S$ at most forward C.G. with flaps retracted. Upper limit is maximum structural cruising speed.
Yellow Arc	143 - 182	Operations must be conducted with caution and only in smooth air.
Red Line	182	Maximum speed for all operations.

Figure 2-2. Airspeed Indicator Markings

## POWER PLANT LIMITATIONS

Engine Manufacturer: Avco Lycoming.

Engine Model Number: O-540-J3C5D.

Engine Operating Limits for Takeoff and Continuous Operations:

Maximum Power: 235 BHP.

Maximum Engine Speed: 2400 RPM.

Maximum Cylinder Head Temperature: 260°C (500°F).

Maximum Oil Temperature: 118°C (245°F).

Oil Pressure, Minimum: 25 psi.

Maximum: 100 psi.

Fuel Pressure, Minimum: 0.5 psi.

Maximum: 8.0 psi.

Propeller Manufacturer: McCauley Accessory Division.

Propeller Model Number: B2D34C214/90DHB-8

Propeller Diameter, Maximum: 82 inches.

Minimum: 80.5 inches.

Propeller Blade Angle at 30 Inch Station, Low: 15.8°.

High: 29.4°.

**POWER PLANT INSTRUMENT MARKINGS**

Power plant instrument markings and their color code significance are shown in figure 2-3.

INSTRUMENT	RED LINE	GREEN ARC	YELLOW ARC	RED LINE
	MINIMUM LIMIT	NORMAL OPERATING	CAUTION RANGE	MAXIMUM LIMIT
Tachometer	---	2100 2400 RPM	---	2400 RPM
Manifold Pressure	---	15-23 in. Hg	---	---
Oil Temperature	---	100° - 245°F	---	245°F
Cylinder Head Temperature	---	200° - 500°F	---	500°F
Fuel Pressure	0.5 psi	0.5 - 8.0 psi	---	8.0 psi
Oil Pressure	25 psi	60 - 90 psi	---	100 psi
Carburetor Air Temperature	---	---	-15° to 5°C	---

Figure 2-3. Power Plant Instrument Markings

**WEIGHT LIMITS**

Maximum Takeoff Weight: 3100 lbs.

Maximum Landing Weight: 3100 lbs.

Maximum Weight in Baggage Compartment:

Baggage Area "A" (or passenger on child's seat) - Station 82 to 110: 120 lbs. See note below.

Baggage Area "B" - Station 110 to 134: 80 lbs. See note below.

**NOTE**

The maximum combined weight capacity for baggage areas A and B is 200 lbs.

## CENTER OF GRAVITY LIMITS

### Center of Gravity Range:

Forward: 33.0 inches aft of datum at 2250 lbs. or less, with straight line variation to 35.5 inches aft of datum at 2700 lbs., with straight line variation to 40.9 inches aft of datum at 3100 lbs.

Aft: 47.0 inches aft of datum at all weights.

Moment Change Due To Retracting Landing Gear: +3052 lb.-ins.

Reference Datum: Front face of firewall.

## MANEUVER LIMITS

This airplane is certificated in the normal category. The normal category is applicable to aircraft intended for non-aerobatic operations. These include any maneuvers incidental to normal flying, stalls (except whip stalls), lazy eights, chandelles, and steep turns in which the angle of bank is not more than 60°.

Aerobatic maneuvers, including spins, are not approved.

## FLIGHT LOAD FACTOR LIMITS

### Flight Load Factors:

\*Flaps Up: +3.8g, -1.52g

\*Flaps Down: +2.0g

\*The design load factors are 150% of the above, and in all cases, the structure meets or exceeds design loads.

## KINDS OF OPERATION LIMITS

The airplane is equipped for day VFR and may be equipped for night VFR and/or IFR operations. FAR Part 91 establishes the minimum required instrumentation and equipment for these operations. The reference to types of flight operations on the operating limitations placard reflects equipment installed at the time of Airworthiness Certificate issuance.

Flight into known icing conditions is prohibited.

## **FUEL LIMITATIONS**

**2 Standard Tanks: 30.5 U.S. gallons each.**

**Total Fuel: 61 U.S. gallons.**

**Usable Fuel (all flight conditions): 56 U.S. gallons.**

**Unusable Fuel: 5.0 U.S. gallons.**

**2 Long Range Tanks: 40 U.S. gallons each.**

**Total Fuel: 80 U.S. gallons.**

**Usable Fuel (all flight conditions): 75 U.S. gallons.**

**Unusable Fuel: 5.0 U.S. gallons.**

### **NOTE**

**To ensure maximum fuel capacity when refueling, place the fuel selector valve in either LEFT or RIGHT position to prevent cross-feeding.**

### **NOTE**

**Takeoff and land with the fuel selector valve handle in the BOTH position.**

**Approved Fuel Grades (and Colors):**

**100LL Grade Aviation Fuel (Blue).**

**100 (Formerly 100/130) Grade Aviation Fuel (Green).**



## PLACARDS

The following information is displayed in the form of composite or individual placards.

1. In full view of the pilot: (The "DAY-NIGHT-VFR-IFR" entry, shown on the example below, will vary as the airplane is equipped.)

This airplane must be operated as a normal category airplane in compliance with the operating limitations as stated in the form of placards, markings, and manuals.

————— MAXIMUMS —————

GROSS WEIGHT . . . . . 3100 lbs  
FLIGHT LOAD FACTOR    Flaps Up . . . +3.8, -1.52  
                              Flaps Down . . . . +2.0

No acrobatic maneuvers, including spins, approved. Altitude loss in a stall recovery - 240 ft. Flight into known icing conditions prohibited. This airplane is certified for the following flight operations as of date of original airworthiness certificate:

DAY—NIGHT—VFR—IFR

2. Near airspeed indicator:

MAX SPEED - KIAS  
MANEUVER . . . 112  
GEAR OPER . . . 140  
GEAR DOWN . . . 140

3. On control lock:

CONTROL LOCK - REMOVE BEFORE STARTING ENGINE.

4. On the fuel selector valve (standard tanks):

OFF  
LEFT - 29 GAL. LEVEL FLIGHT ONLY  
BOTH - 56 GAL. ALL FLIGHT ATTITUDES  
TAKEOFF AND LANDING  
RIGHT - 29 GAL. LEVEL FLIGHT ONLY

On the fuel selector valve (long range tanks):

OFF  
LEFT - 37 GAL. LEVEL FLIGHT ONLY  
BOTH - 75 GAL. ALL FLIGHT ATTITUDES  
TAKEOFF AND LANDING  
RIGHT - 37 GAL. LEVEL FLIGHT ONLY

5. On the baggage door:

120 POUNDS MAXIMUM  
BAGGAGE AND/OR AUXILIARY PASSENGER  
FORWARD OF BAGGAGE DOOR LATCH AND  
80 POUNDS MAXIMUM  
BAGGAGE AFT OF BAGGAGE DOOR LATCH  
MAXIMUM 200 POUNDS COMBINED  
FOR ADDITIONAL LOADING INSTRUCTIONS  
SEE WEIGHT AND BALANCE DATA

6. On flap control indicator:

0° to 10°

(Partial flap range with blue color  
code and 140 kt callout; also, me-  
chanical detent at 10°.)

10° to 20° to FULL

(Indices at these positions with white  
color code and 95 kt callout; also,  
mechanical detent at 10° and 20°.)

7. Forward of fuel tank filler cap (standard tanks):

SERVICE THIS AIRPLANE WITH 100LL/100 MIN. AVIA-  
TION GRADE GASOLINE — CAPACITY 30.5 GAL.

Forward of fuel tank filler cap (long range tanks):

SERVICE THIS AIRPLANE WITH 100LL/100 MIN. AVIA-  
TION GRADE GASOLINE — CAPACITY 40.0 GAL.

8. Near gear hand pump:

MANUAL  
GEAR EXTENSION  
1. SELECT GEAR DOWN  
2. PULL HANDLE FWD  
3. PUMP VERTICALLY  
CAUTION  
DO NOT PUMP WITH  
GEAR UP SELECTED



# SECTION 3

# EMERGENCY PROCEDURES

## TABLE OF CONTENTS

	Page
Introduction . . . . .	3-3
Airspeeds For Emergency Operation . . . . .	3-3
OPERATIONAL CHECKLISTS	
Engine Failures . . . . .	3-3
Engine Failure During Takeoff Run . . . . .	3-3
Engine Failure Immediately After Takeoff . . . . .	3-4
Engine Failure During Flight . . . . .	3-4
Forced Landings . . . . .	3-4
Emergency Landing Without Engine Power . . . . .	3-4
Precautionary Landing With Engine Power . . . . .	3-4
Ditching . . . . .	3-5
Fires . . . . .	3-5
During Start On Ground . . . . .	3-5
Engine Fire In Flight . . . . .	3-6
Electrical Fire In Flight . . . . .	3-6
Cabin Fire . . . . .	3-7
Wing Fire . . . . .	3-7
Icing . . . . .	3-7
Inadvertent Icing Encounter . . . . .	3-7
Static Source Blockage (Erroneous Instrument Reading Suspected) . . . . .	3-8
Landing Gear Malfunction Procedures . . . . .	3-8
Landing Gear Fails To Retract . . . . .	3-8
Landing Gear Fails To Extend . . . . .	3-8
Gear Up Landing . . . . .	3-9
Landing Without Positive Indication Of Gear Locking . . . . .	3-9
Landing With A Defective Nose Gear (Or Flat Nose Tire) . . . . .	3-9
Landing With A Flat Main Tire . . . . .	3-10
Electrical Power Supply System Malfunctions . . . . .	3-10
Over-Voltage Light Illuminates . . . . .	3-10
Ammeter Shows Discharge . . . . .	3-10

**TABLE OF CONTENTS (Continued)**

	Page
<b>AMPLIFIED PROCEDURES</b>	
Engine Failure . . . . .	3-11
Forced Landings . . . . .	3-12
Landing Without Elevator Control . . . . .	3-12
Fires . . . . .	3-12
Emergency Operation In Clouds (Vacuum System Failure) . . . . .	3-13
Executing A 180° Turn In Clouds . . . . .	3-13
Emergency Descent Through Clouds . . . . .	3-13
Recovery From A Spiral Dive . . . . .	3-14
Flight In Icing Conditions . . . . .	3-14
Static Source Blocked . . . . .	3-14
Spins . . . . .	3-15
Rough Engine Operation Or Loss Of Power . . . . .	3-16
Carburetor Icing . . . . .	3-16
Spark Plug Fouling . . . . .	3-16
Magneto Malfunction . . . . .	3-16
Engine-Driven Fuel Pump Failure . . . . .	3-16
Low Oil Pressure . . . . .	3-16
Landing Gear Malfunction Procedures . . . . .	3-17
Retraction Malfunctions . . . . .	3-17
Extension Malfunctions . . . . .	3-17
Gear Up Landing . . . . .	3-18
Electrical Power Supply System Malfunctions . . . . .	3-18
Excessive Rate Of Charge . . . . .	3-18
Insufficient Rate Of Charge . . . . .	3-19

## INTRODUCTION

Section 3 provides checklist and amplified procedures for coping with emergencies that may occur. Emergencies caused by airplane or engine malfunctions are extremely rare if proper preflight inspections and maintenance are practiced. Enroute weather emergencies can be minimized or eliminated by careful flight planning and good judgment when unexpected weather is encountered. However, should an emergency arise, the basic guidelines described in this section should be considered and applied as necessary to correct the problem. Emergency procedures associated with ELT and other optional systems can be found in Section 9.

## AIRSPEEDS FOR EMERGENCY OPERATION

### Engine Failure After Takeoff:

Wing Flaps Up . . . . .	70 KIAS
Wing Flaps Down . . . . .	65 KIAS

### Maneuvering Speed:

3100 Lbs . . . . .	112 KIAS
2550 Lbs . . . . .	101 KIAS
2000 Lbs . . . . .	89 KIAS

### Maximum Glide:

3100 Lbs . . . . .	80 KIAS
2550 Lbs . . . . .	72 KIAS
2000 Lbs . . . . .	64 KIAS

Precautionary Landing With Engine Power . . . . .	65 KIAS
---	---------

### Landing Without Engine Power:

Wing Flaps Up . . . . .	75 KIAS
Wing Flaps Down . . . . .	65 KIAS

## OPERATIONAL CHECKLISTS

### ENGINE FAILURES

#### ENGINE FAILURE DURING TAKEOFF RUN

1. Throttle -- IDLE.
2. Brakes -- APPLY.
3. Wing Flaps -- RETRACT.
4. Mixture -- IDLE CUT-OFF.
5. Ignition Switch -- OFF.
6. Master Switch -- OFF.

### ENGINE FAILURE IMMEDIATELY AFTER TAKEOFF

1. Airspeed -- 70 KIAS (flaps UP).  
65 KIAS (flaps DOWN).
2. Mixture -- IDLE CUT-OFF.
3. Fuel Selector Valve -- OFF.
4. Ignition Switch -- OFF.
5. Wing Flaps -- AS REQUIRED (40° recommended).
6. Master Switch -- OFF.

### ENGINE FAILURE DURING FLIGHT

1. Airspeed -- 80 KIAS.
2. Carburetor Heat -- ON.
3. Fuel Selector Valve -- BOTH
4. Mixture -- RICH.
5. Ignition Switch -- BOTH (or START if propeller is stopped).
6. Primer -- IN and LOCKED.

## FORCED LANDINGS

### EMERGENCY LANDING WITHOUT ENGINE POWER

1. Airspeed -- 70 KIAS (flaps UP).  
65 KIAS (flaps DOWN).
2. Mixture -- IDLE CUT-OFF.
3. Fuel Selector Valve -- OFF.
4. Ignition Switch -- OFF.
5. Landing Gear -- DOWN (UP if terrain is rough or soft).
6. Wing Flaps -- AS REQUIRED (40° recommended).
7. Doors -- UNLATCH PRIOR TO TOUCHDOWN.
8. Master Switch -- OFF when landing is assured.
9. Touchdown -- SLIGHTLY TAIL LOW.
10. Brakes -- APPLY HEAVILY.

### PRECAUTIONARY LANDING WITH ENGINE POWER

1. Airspeed -- 65 KIAS.
2. Wing Flaps -- 20°.
3. Selected Field -- FLY OVER, noting terrain and obstructions, then retract flaps upon reaching a safe altitude and airspeed.
4. Electrical Switches -- OFF.
5. Landing Gear -- DOWN (UP if terrain is rough or soft).
6. Wing Flaps -- 40° (on final approach).
7. Airspeed -- 65 KIAS.



8. Doors -- UNLATCH PRIOR TO TOUCHDOWN.
9. Avionics Power and Master Switches -- OFF.
10. Touchdown -- SLIGHTLY TAIL LOW.
11. Ignition Switch -- OFF.
12. Brakes -- APPLY HEAVILY.

## DITCHING

1. Radio -- TRANSMIT MAYDAY on 121.5 MHz, giving location and intentions.
2. Heavy Objects (in baggage area) -- SECURE OR JETTISON.
3. Landing Gear -- UP.
4. Flaps -- 20° - 40°.
5. Power -- ESTABLISH 300 FT/MIN DESCENT at 60 KIAS.
6. Approach -- High Winds, Heavy Seas -- INTO THE WIND.  
Light Winds, Heavy Swells -- PARALLEL TO SWELLS.

### NOTE

If no power is available, approach at 70 KIAS with flaps up or at 65 KIAS with 10° flaps.

7. Cabin Doors -- UNLATCH.
8. Touchdown -- LEVEL ATTITUDE AT ESTABLISHED DESCENT.
9. Face -- CUSHION at touchdown with folded coat.
10. Airplane -- EVACUATE through cabin doors. If necessary, open windows and flood cabin to equalize pressure so doors can be opened.
11. Life Vests and Raft -- INFLATE.

## FIRES

### DURING START ON GROUND

1. Cranking -- CONTINUE, to get a start which would suck the flames and accumulated fuel through the carburetor and into the engine.

If engine starts:

2. Power -- 1700 RPM for a few minutes.
3. Engine -- SHUTDOWN and inspect for damage.

If engine fails to start:

4. Throttle -- FULL OPEN.

5. Mixture -- IDLE CUT-OFF.
6. Cranking -- CONTINUE.
7. Fire Extinguisher -- OBTAIN (have ground attendants obtain if not installed).
8. Engine -- SECURE.
  - a. Master Switch -- OFF.
  - b. Ignition Switch -- OFF.
  - c. Fuel Selector Valve -- OFF.
9. Fire -- EXTINGUISH using fire extinguisher, wool blanket, or dirt.
10. Fire Damage -- INSPECT, repair damage or replace damaged components or wiring before conducting another flight.

#### ENGINE FIRE IN FLIGHT

1. Mixture -- IDLE CUT-OFF.
2. Fuel Selector Valve -- OFF.
3. Master Switch -- OFF.
4. Cabin Heat and Air -- OFF (except overhead vents).
5. Airspeed -- 100 KIAS (If fire is not extinguished, increase glide speed to find an airspeed which will provide an incombustible mixture).
6. Forced Landing -- EXECUTE (as described in Emergency Landing Without Engine Power).

#### ELECTRICAL FIRE IN FLIGHT

1. Master Switch -- OFF.
2. Avionics Power Switch -- OFF.
3. All Other Switches (except ignition switch) -- OFF.
4. Vents/Cabin Air/Heat -- CLOSED.
5. Fire Extinguisher -- ACTIVATE (if available).

### WARNING

After discharging an extinguisher within a closed cabin, ventilate the cabin.

If fire appears out and electrical power is necessary for continuance of flight:

6. Master Switch -- ON.
7. Circuit Breakers -- CHECK for faulty circuit, do not reset.
8. Radio Switches -- OFF.
9. Avionics Power Switch -- ON.
10. Radio/Electrical Switches -- ON one at a time, with delay after each until short circuit is localized.

11. Vents/Cabin Air/Heat -- OPEN when it is ascertained that fire is completely extinguished.

### **CABIN FIRE**

1. Master Switch -- OFF.
2. Vents/Cabin Air/Heat -- CLOSED (to avoid drafts).
3. Fire Extinguisher -- ACTIVATE (if available).

### **WARNING**

After discharging an extinguisher within a closed cabin, ventilate the cabin.

4. Land the airplane as soon as possible to inspect for damage.

### **WING FIRE**

1. Navigation Light Switch -- OFF.
2. Strobe Light Switch (if installed) -- OFF.
3. Pitot Heat Switch (if installed) -- OFF.

### **NOTE**

Perform a sideslip to keep the flames away from the fuel tank and cabin, and land as soon as possible using flaps only as required for final approach and touchdown.

## **ICING**

### **INADVERTENT ICING ENCOUNTER**

1. Turn pitot heat switch ON (if installed).
2. Turn back or change altitude to obtain an outside air temperature that is less conducive to icing.
3. Pull cabin heat control full out and rotate defroster control clockwise to obtain maximum defroster airflow.
4. Increase engine speed to minimize ice build-up on propeller blades.
5. Watch for signs of carburetor air filter ice and apply carburetor heat as required. An unexplained loss in manifold pressure could be caused by carburetor ice or air intake filter ice. Lean the mixture if carburetor heat is used continuously.

6. Plan a landing at the nearest airport. With an extremely rapid ice build-up, select a suitable "off airport" landing site.
7. With an ice accumulation of 1/4 inch or more on the wing leading edges, be prepared for significantly higher stall speed.
8. Leave wing flaps retracted. With a severe ice build-up on the horizontal tail, the change in wing wake airflow direction caused by wing flap extension could result in a loss of elevator effectiveness.
9. Open the window and, if practical, scrape ice from a portion of the windshield for visibility in the landing approach.
10. Perform a landing approach using a forward slip, if necessary, for improved visibility.
11. Approach at 85 to 95 KIAS, depending upon the amount of ice accumulation.
12. Perform a landing in level attitude.

**STATIC SOURCE BLOCKAGE  
(Erroneous Instrument Reading Suspected)**

1. Alternate Static Source Valve -- PULL ON.
2. Airspeed -- Consult appropriate table in Section 5.
3. Altitude -- Cruise 50 feet higher and approach 30 feet higher than normal.

**LANDING GEAR MALFUNCTION PROCEDURES**

**LANDING GEAR FAILS TO RETRACT**

1. Master Switch -- ON.
2. Landing Gear Lever -- CHECK (lever full up).
3. Landing Gear and Gear Pump Circuit Breakers -- IN.
4. Gear Up Light -- CHECK.
5. Landing Gear Lever -- RECYCLE.
6. Gear Motor -- CHECK operation (ammeter and noise).

**LANDING GEAR FAILS TO EXTEND**

1. Landing Gear Lever -- DOWN.
2. Emergency Hand Pump -- EXTEND HANDLE, and PUMP (perpendicular to handle until resistance becomes heavy -- about 20 cycles).
3. Gear Down Light -- ON.
4. Pump Handle -- STOW.

### GEAR UP LANDING

1. Landing Gear Lever -- UP.
2. Landing Gear and Gear Pump Circuit Breakers -- IN.
3. Runway -- SELECT longest hard surface or smooth sod runway available.
4. Wing Flaps -- 40° (on final approach).
5. Airspeed -- 65 KIAS.
6. Doors -- UNLATCH PRIOR TO TOUCHDOWN.
7. Avionics Power and Master Switches -- OFF when landing is assured.
8. Touchdown -- SLIGHTLY TAIL LOW.
9. Mixture -- IDLE CUT-OFF.
10. Ignition Switch -- OFF.
11. Fuel Selector Valve -- OFF.
12. Airplane -- EVACUATE.

### LANDING WITHOUT POSITIVE INDICATION OF GEAR LOCKING

1. Before Landing Check -- COMPLETE.
2. Approach -- NORMAL (full flap).
3. Landing Gear and Gear Pump Circuit Breakers -- IN.
4. Landing -- TAIL LOW as smoothly as possible.
5. Braking -- MINIMUM necessary.
6. Taxi -- SLOWLY.
7. Engine -- SHUTDOWN before inspecting gear.

### LANDING WITH A DEFECTIVE NOSE GEAR (Or Flat Nose Tire)

1. Movable Load -- TRANSFER to baggage area.
2. Passenger -- MOVE to rear seat.
3. Before Landing Checklist -- COMPLETE.
4. Runway -- HARD SURFACE or SMOOTH SOD.
5. Wing Flaps -- 40°
6. Cabin Doors -- UNLATCH PRIOR TO TOUCHDOWN.
7. Avionics Power and Master Switches -- OFF when landing is assured.
8. Land -- SLIGHTLY TAIL LOW.
9. Mixture -- IDLE CUT-OFF.
10. Ignition Switch -- OFF.
11. Fuel Selector Valve -- OFF.
12. Elevator Control -- HOLD NOSE OFF GROUND as long as possible.
13. Airplane -- EVACUATE as soon as it stops.

**LANDING WITH A FLAT MAIN TIRE**

1. Approach -- NORMAL (full flap).
2. Touchdown -- GOOD TIRE FIRST, hold airplane off flat tire as long as possible with aileron control.
3. Directional Control -- MAINTAIN using brake on good wheel as required.

**ELECTRICAL POWER SUPPLY SYSTEM  
MALFUNCTIONS**

**OVER-VOLTAGE LIGHT ILLUMINATES**

1. Avionics Power Switch -- OFF.
2. Master Switch -- OFF (both sides).
3. Master Switch -- ON.
4. Over-Voltage Light -- OFF.
5. Avionics Power Switch -- ON.

If over-voltage light illuminates again:

6. Flight -- TERMINATE as soon as practical.

**AMMETER SHOWS DISCHARGE**

1. Alternator -- OFF.
2. Nonessential Radio/Electrical Equipment -- OFF.
3. Flight -- TERMINATE as soon as practical.

## AMPLIFIED PROCEDURES

### ENGINE FAILURE

If an engine failure occurs during the takeoff run, the most important thing to do is stop the airplane on the remaining runway. Those extra items on the checklist will provide added safety after a failure of this type.

Prompt lowering of the nose to maintain airspeed and establish a glide attitude is the first response to an engine failure after takeoff. In most cases, the landing should be planned straight ahead with only small changes in direction to avoid obstructions. Altitude and airspeed are seldom sufficient to execute a 180° gliding turn necessary to return to the runway. The checklist procedures assume that adequate time exists to secure the fuel and ignition systems prior to touchdown.

After an engine failure in flight, the best glide speed as shown in figure 3-1 should be established as quickly as possible. While gliding toward a suitable landing area, an effort should be made to identify the cause of the failure. If time permits, an engine restart should be attempted as shown in the checklist. If the engine cannot be restarted, a forced landing without power must be completed.

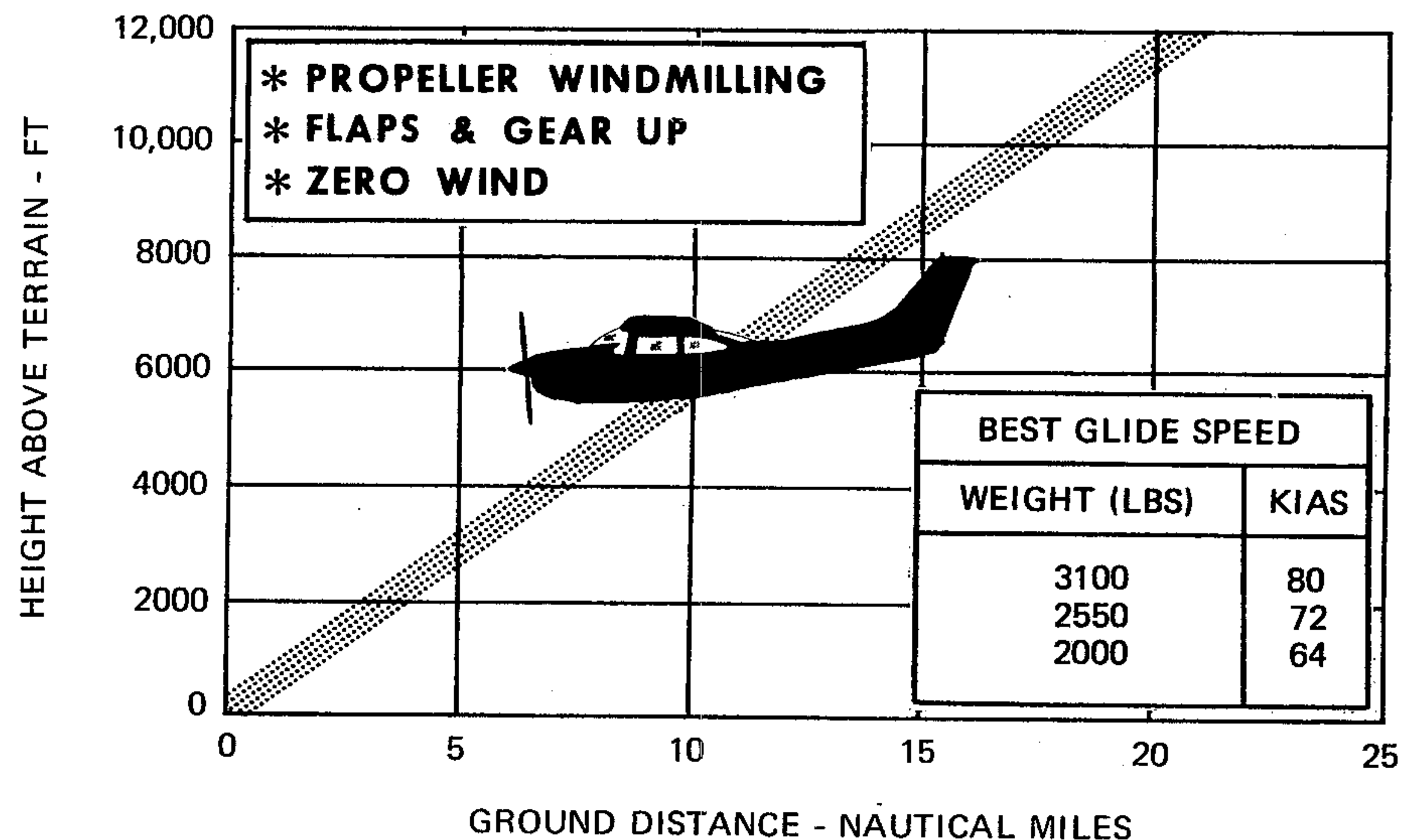

Figure 3-1. Maximum Glide

## FORCED LANDINGS

If all attempts to restart the engine fail and a forced landing is imminent, select a suitable field and prepare for the landing as discussed in the checklist for Emergency Landing Without Engine Power.

Before attempting an "off airport" landing with engine power available, one should fly over the landing area at a safe but low altitude to inspect the terrain for obstructions and surface conditions, proceeding as discussed under the Precautionary Landing With Engine Power checklist.

Prepare for ditching by securing or jettisoning heavy objects located in the baggage area and collect folded coats for protection of occupants' face at touchdown. Transmit Mayday message on 121.5 MHz giving location and intentions. Avoid a landing flare because of difficulty in judging height over a water surface.

In a forced landing situation, do not turn off the avionics power and master switches until a landing is assured. Premature deactivation of the switches will disable the encoding altimeter and airplane electrical systems.

## LANDING WITHOUT ELEVATOR CONTROL

Trim for horizontal flight with an airspeed of approximately 80 KIAS by using throttle and elevator trim control. Then **do not change the elevator trim control setting**; control the glide angle by adjusting power exclusively.

At flareout, the nose-down moment resulting from power reduction is an adverse factor and the airplane may hit on the nose wheel. Consequently, at flareout, the elevator trim control should be adjusted toward the full nose-up position and the power adjusted so that the airplane will rotate to the horizontal attitude for touchdown. Close the throttle at touchdown.

## FIRES

Although engine fires are extremely rare in flight, the steps of the appropriate checklist should be followed if one is encountered. After completion of this procedure, execute a forced landing. Do not attempt to restart the engine.

The initial indication of an electrical fire is usually the odor of burning insulation. The checklist for this problem should result in elimination of the fire.



## **EMERGENCY OPERATION IN CLOUDS**

### **(Vacuum System Failure)**

In the event of a vacuum system failure during flight, the directional indicator and attitude indicator will be disabled, and the pilot will have to rely on the turn coordinator if he inadvertently flies into clouds. The following instructions assume that only the electrically-powered turn coordinator is operative, and that the pilot is not completely proficient in instrument flying.

### **EXECUTING A 180° TURN IN CLOUDS**

Upon inadvertently entering the clouds, an immediate plan should be made to turn back as follows:

1. Note the compass heading.
2. Note the time of the minute hand and observe the position of the sweep second hand on the clock.
3. When the sweep second hand indicates the nearest half-minute, initiate a standard rate left turn, holding the turn coordinator symbolic airplane wing opposite the lower left index mark for 60 seconds. Then roll back to level flight by leveling the miniature airplane.
4. Check accuracy of the turn by observing the compass heading which should be the reciprocal of the original heading.
5. If necessary, adjust heading primarily with skidding motions rather than rolling motions so that the compass will read more accurately.
6. Maintain altitude and airspeed by cautious application of elevator control. Avoid overcontrolling by keeping the hands off the control wheel as much as possible and steering only with rudder.

### **EMERGENCY DESCENT THROUGH CLOUDS**

If conditions preclude reestablishment of VFR flight by a 180° turn, a descent through a cloud deck to VFR conditions may be appropriate. If possible, obtain radio clearance for an emergency descent through clouds. To guard against a spiral dive, choose an easterly or westerly heading to minimize compass card swings due to changing bank angles. In addition, keep hands off the control wheel and steer a straight course with rudder control by monitoring the turn coordinator. Occasionally check the compass heading and make minor corrections to hold an approximate course. Before descending into the clouds, set up a stabilized let-down condition as follows:

1. Extend landing gear.

2. Apply full rich mixture.
3. Apply full carburetor heat.
4. Reduce power to set up a 500 to 800 ft/min rate of descent.
5. Adjust the elevator and rudder trim control wheels for a stabilized descent at 80 KIAS.
6. Keep hands off control wheel.
7. Monitor turn coordinator and make corrections by rudder alone.
8. Adjust rudder trim to relieve unbalanced rudder force, if present.
9. Check trend of compass card movement and make cautious corrections with rudder to stop turn.
10. Upon breaking out of clouds, resume normal cruising flight.

### RECOVERY FROM A SPIRAL DIVE

If a spiral is encountered, proceed as follows:

1. Close the throttle.
2. Stop the turn by using coordinated aileron and rudder control to align the symbolic airplane in the turn coordinator with the horizon reference line.
3. Cautiously apply elevator back pressure to slowly reduce the indicated airspeed to 80 KIAS.
4. Adjust the elevator trim control to maintain an 80 KIAS glide.
5. Keep hands off the control wheel, using rudder control to hold a straight heading. Use rudder trim to relieve unbalanced rudder force, if present.
6. Apply carburetor heat.
7. Clear engine occasionally, but avoid using enough power to disturb the trimmed glide.
8. Upon breaking out of clouds, resume normal cruising flight.

### FLIGHT IN ICING CONDITIONS

Flight into icing conditions is prohibited. An inadvertent encounter with these conditions can best be handled using the checklist procedures. The best procedure, of course, is to turn back or change altitude to escape icing conditions.

### STATIC SOURCE BLOCKED

If erroneous readings of the static source instruments (airspeed, altimeter and rate-of-climb) are suspected, the alternate static source valve should be pulled on, thereby supplying static pressure to these instruments from the cabin. Cabin pressures will vary with open ventilators or windows and with airspeed. To avoid the possibility of large errors, the windows should not be open when using the alternate static source.

#### NOTE

In an emergency on airplanes not equipped with an alternate static source, cabin pressure can be supplied to the static pressure instruments by breaking the glass in the face of the rate-of-climb indicator.

A calibration table is provided in Section 5 to illustrate the effect of the alternate static source on indicated airspeeds. With the windows and vents closed the airspeed indicator may typically read as much as 3 knots faster and the altimeter 50 feet higher in cruise. With the vents open, this variation reduces to zero. If the alternate static source must be used for landing, the normal indicated approach speed may be used since the indicated airspeed variations in this configuration are 2 knots or less.

## SPINS

Intentional spins are prohibited in this airplane. Should an inadvertent spin occur, the following recovery procedure should be used:

1. RETARD THROTTLE TO IDLE POSITION.
2. PLACE AILERONS IN NEUTRAL POSITION.
3. APPLY AND HOLD FULL RUDDER OPPOSITE TO THE DIRECTION OF ROTATION.
4. JUST AFTER THE RUDDER REACHES THE STOP, MOVE THE WHEEL BRISKLY FORWARD FAR ENOUGH TO BREAK THE STALL. Full down elevator may be required at aft center of gravity loadings to assure optimum recoveries.
5. HOLD THESE CONTROL INPUTS UNTIL ROTATION STOPS. Premature relaxation of the control inputs may extend the recovery.
6. AS ROTATION STOPS, NEUTRALIZE RUDDER, AND MAKE A SMOOTH RECOVERY FROM THE RESULTING DIVE.

#### NOTE

If disorientation precludes a visual determination of the direction of rotation, the symbolic airplane in the turn coordinator may be referred to for this information.

## **ROUGH ENGINE OPERATION OR LOSS OF POWER**

### **CARBURETOR ICING**

An unexplained drop in manifold pressure and eventual engine roughness may result from the formation of carburetor ice. To clear the ice, apply full throttle and pull the carburetor heat knob full out until the engine runs smoothly; then remove carburetor heat and readjust the throttle. If conditions require the continued use of carburetor heat in cruise flight, use the minimum amount of heat necessary to prevent ice from forming and lean the mixture for smoothest engine operation.

### **SPARK PLUG FOULING**

A slight engine roughness in flight may be caused by one or more spark plugs becoming fouled by carbon or lead deposits. This may be verified by turning the ignition switch momentarily from BOTH to either L or R position. An obvious power loss in single ignition operation is evidence of spark plug or magneto trouble. Assuming that spark plugs are the more likely cause, lean the mixture to the recommended lean setting for cruising flight. If the problem does not clear up in several minutes, determine if a richer mixture setting will produce smoother operation. If not, proceed to the nearest airport for repairs using the BOTH position of the ignition switch unless extreme roughness dictates the use of a single ignition position.

### **MAGNETO MALFUNCTION**

A sudden engine roughness or misfiring is usually evidence of magneto problems. Switching from BOTH to either L or R ignition switch position will identify which magneto is malfunctioning. Select different power settings and enrichen the mixture to determine if continued operation on BOTH magnetos is practicable. If not, switch to the good magneto and proceed to the nearest airport for repairs.

### **ENGINE - DRIVEN FUEL PUMP FAILURE**

In the event of an engine-driven fuel pump failure, gravity flow will provide sufficient fuel flow for level or descending flight. However, in a climbing attitude or anytime the fuel pressure drops to 0.5 PSI, the auxiliary fuel pump should be turned on.

### **LOW OIL PRESSURE**

If low oil pressure is accompanied by normal oil temperature, there is a possibility the oil pressure gage or relief valve is malfunctioning. A leak

in the line to the gage is not necessarily cause for an immediate precautionary landing because an orifice in this line will prevent a sudden loss of oil from the engine sump. However, a landing at the nearest airport would be advisable to inspect the source of trouble.

If a total loss of oil pressure is accompanied by a rise in oil temperature, there is good reason to suspect an engine failure is imminent. Reduce engine power immediately and select a suitable forced landing field. Use only the minimum power required to reach the desired touchdown spot.

## LANDING GEAR MALFUNCTION PROCEDURES

In the event of possible landing gear retraction or extension malfunctions, there are several general checks that should be made prior to initiating the steps outlined in the following paragraphs.

In analyzing a landing gear malfunction, first check that the master switch is ON and the LDG GEAR and GEAR PUMP circuit breakers are in; reset, if necessary. Also, check both landing gear position indicator lights for operation by "pressing-to-test" the light units and rotating them at the same time to check for open dimming shutters. A burned-out bulb can be replaced in flight by using the bulb from the remaining gear position indicator light.

### RETRACTION MALFUNCTIONS

If the landing gear fails to retract normally, or an intermittent GEAR UP indicator light is present, check the indicator light for proper operation and attempt to recycle the landing gear. Place the landing gear lever in the GEAR DOWN position. When the GEAR DOWN light illuminates, reposition the gear lever in the GEAR UP position for another retraction attempt. If the GEAR UP indicator light still fails to illuminate, the flight may be continued to an airport having maintenance facilities, if practical. If gear motor operation is audible after a period of one minute following gear lever retraction actuation, pull the GEAR PUMP circuit breaker switch to prevent the electric motor from overheating. In this event, remember to re-engage the circuit breaker switch just prior to landing. Intermittent gear motor operation may also be detected by momentary fluctuations of the ammeter needle.

### EXTENSION MALFUNCTIONS

Normal landing gear extension time is approximately 5 seconds. If the landing gear will not extend normally, perform the general checks of circuit breakers and master switch and repeat the normal extension

procedures at a reduced airspeed of 100 KIAS. The landing gear lever must be in the down position with the detent engaged. If efforts to extend and lock the gear through the normal landing gear system fail, the gear can be manually extended (as long as hydraulic system fluid has not been completely lost) by use of the emergency hand pump. The hand pump is located between the front seats.

A checklist is provided for step-by-step instructions for a manual gear extension.

If gear motor operation is audible after a period of one minute following gear lever extension actuation, pull the GEAR PUMP circuit breaker to prevent the electric motor from overheating. In this event, remember to re-engage the circuit breaker just prior to landing.

### **GEAR UP LANDINGS**

If the landing gear remains retracted or is only partially extended, and all efforts to fully extend it (including manual extension) have failed, plan a wheels-up landing. In preparation for landing, reposition the landing gear lever to GEAR UP and push the LDG GEAR and GEAR PUMP circuit breakers in to allow the landing gear to swing into the gear wells at touchdown. Then proceed in accordance with the checklist.

## **ELECTRICAL POWER SUPPLY SYSTEM MALFUNCTIONS**

Malfunctions in the electrical power supply system can be detected by periodic monitoring of the ammeter and over-voltage warning light; however, the cause of these malfunctions is usually difficult to determine. A broken alternator drive belt or wiring is most likely the cause of alternator failures, although other factors could cause the problem. A damaged or improperly adjusted voltage regulator can also cause malfunctions. Problems of this nature constitute an electrical emergency and should be dealt with immediately. Electrical power malfunctions usually fall into two categories: excessive rate of charge and insufficient rate of charge. The following paragraphs describe the recommended remedy for each situation.

### **EXCESSIVE RATE OF CHARGE**

After engine starting and heavy electrical usage at low engine speeds (such as extended taxiing) the battery condition will be low enough to accept above normal charging during the initial part of a flight. However,

after thirty minutes of cruising flight, the ammeter should be indicating less than two needle widths of charging current. If the charging rate were to remain above this value on a long flight, the battery would overheat and evaporate the electrolyte at an excessive rate. Electronic components in the electrical system could be adversely affected by higher than normal voltage if a faulty voltage regulator is causing the overcharging. To preclude these possibilities, an over-voltage sensor will automatically shut down the alternator and the over-voltage warning light will illuminate if the charge voltage reaches approximately 31.5 volts. Assuming that the malfunction was only momentary, an attempt should be made to reactivate the alternator system. To do this, turn the avionics power switch off, then turn both sides of the master switch off and then on again. If the problem no longer exists, normal alternator charging will resume and the warning light will go off. The avionics power switch should then be turned on. If the light illuminates again, a malfunction is confirmed. In this event, the flight should be terminated and/or the current drain on the battery minimized because the battery can supply the electrical system for only a limited period of time. If the emergency occurs at night, power must be conserved for later operation of the landing gear, wing flaps and possible use of the landing lights during landing.

#### **INSUFFICIENT RATE OF CHARGE**

If the ammeter indicates a continuous discharge rate in flight, the alternator is not supplying power to the system and should be shut down since the alternator field circuit may be placing an unnecessary load on the system. All nonessential equipment should be turned off and the flight terminated as soon as practical.





# SECTION 4

# NORMAL PROCEDURES

## TABLE OF CONTENTS

	Page
Introduction . . . . .	4-3
Speeds For Normal Operation . . . . .	4-3
<b>CHECKLIST PROCEDURES</b>	
Preflight Inspection . . . . .	4-5
Cabin . . . . .	4-5
Empennage . . . . .	4-5
Right Wing, Trailing Edge . . . . .	4-5
Right Wing . . . . .	4-5
Nose . . . . .	4-5
Left Wing . . . . .	4-6
Left Wing, Leading Edge . . . . .	4-6
Left Wing, Trailing Edge . . . . .	4-6
Before Starting Engine . . . . .	4-6
Starting Engine . . . . .	4-7
Before Takeoff . . . . .	4-7
Takeoff . . . . .	4-8
Normal Takeoff . . . . .	4-8
Short Field Takeoff . . . . .	4-8
Enroute Climb . . . . .	4-8
Normal Climb . . . . .	4-8
Maximum Performance Climb . . . . .	4-9
Cruise . . . . .	4-9
Descent . . . . .	4-9
Before Landing . . . . .	4-9
Landing . . . . .	4-10
Normal Landing . . . . .	4-10
Short Field Landing . . . . .	4-10
Balked Landing . . . . .	4-10
After Landing . . . . .	4-10
Securing Airplane . . . . .	4-11

## TABLE OF CONTENTS (Continued)

	Page
AMPLIFIED PROCEDURES	
Starting Engine . . . . .	4-13
Taxiing . . . . .	4-13
Before Takeoff . . . . .	4-15
Warm-Up . . . . .	4-15
Magneto Check . . . . .	4-15
Alternator Check . . . . .	4-15
Takeoff . . . . .	4-15
Power Check . . . . .	4-15
Wing Flap Settings . . . . .	4-16
Crosswind Takeoff . . . . .	4-16
Landing Gear Retraction . . . . .	4-16
Enroute Climb . . . . .	4-17
Cruise . . . . .	4-17
Leaning With A Cessna Economy Mixture Indicator (EGT) . . . . .	4-19
Stalls . . . . .	4-20
Before Landing . . . . .	4-20
Landing . . . . .	4-20
Normal Landing . . . . .	4-20
Short Field Landing . . . . .	4-20
Crosswind Landing . . . . .	4-21
Balked Landing . . . . .	4-21
Cold Weather Operation . . . . .	4-21
Starting . . . . .	4-21
Operation . . . . .	4-23
Hot Weather Operation . . . . .	4-23
Noise Abatement . . . . .	4-23

## INTRODUCTION

Section 4 provides checklist and amplified procedures for the conduct of normal operation. Normal procedures associated with optional systems can be found in Section 9.

## SPEEDS FOR NORMAL OPERATION

Unless otherwise noted, the following speeds are based on a maximum weight of 3100 pounds and may be used for any lesser weight. However, to achieve the performance specified in Section 5 for takeoff distance, the speed appropriate to the particular weight must be used.

### Takeoff:

Normal Climb Out . . . . . 70-80 KIAS  
Short Field Takeoff, Flaps 20°, Speed at 50 Feet . . . . . 55 KIAS

### Enroute Climb, Flaps and Gear Up:

Normal . . . . . 90-100 KIAS  
Best Rate of Climb, Sea Level . . . . . 88 KIAS  
Best Rate of Climb, 10,000 Feet . . . . . 74 KIAS  
Best Angle of Climb, Sea Level . . . . . 64 KIAS  
Best Angle of Climb, 10,000 Feet . . . . . 66 KIAS

### Landing Approach:

Normal Approach, Flaps Up . . . . . 70-80 KIAS  
Normal Approach, Flaps 40° . . . . . 65-75 KIAS  
Short Field Approach, Flaps 40° . . . . . 63 KIAS

### Balked Landing:

Maximum Power, Flaps 20° . . . . . 75 KIAS

### Maximum Recommended Turbulent Air Penetration Speed:

3100 Lbs . . . . . 112 KIAS  
2550 Lbs . . . . . 101 KIAS  
2000 Lbs . . . . . 89 KIAS

### Maximum Demonstrated Crosswind Velocity:

Takeoff or Landing . . . . . 18 KNOTS

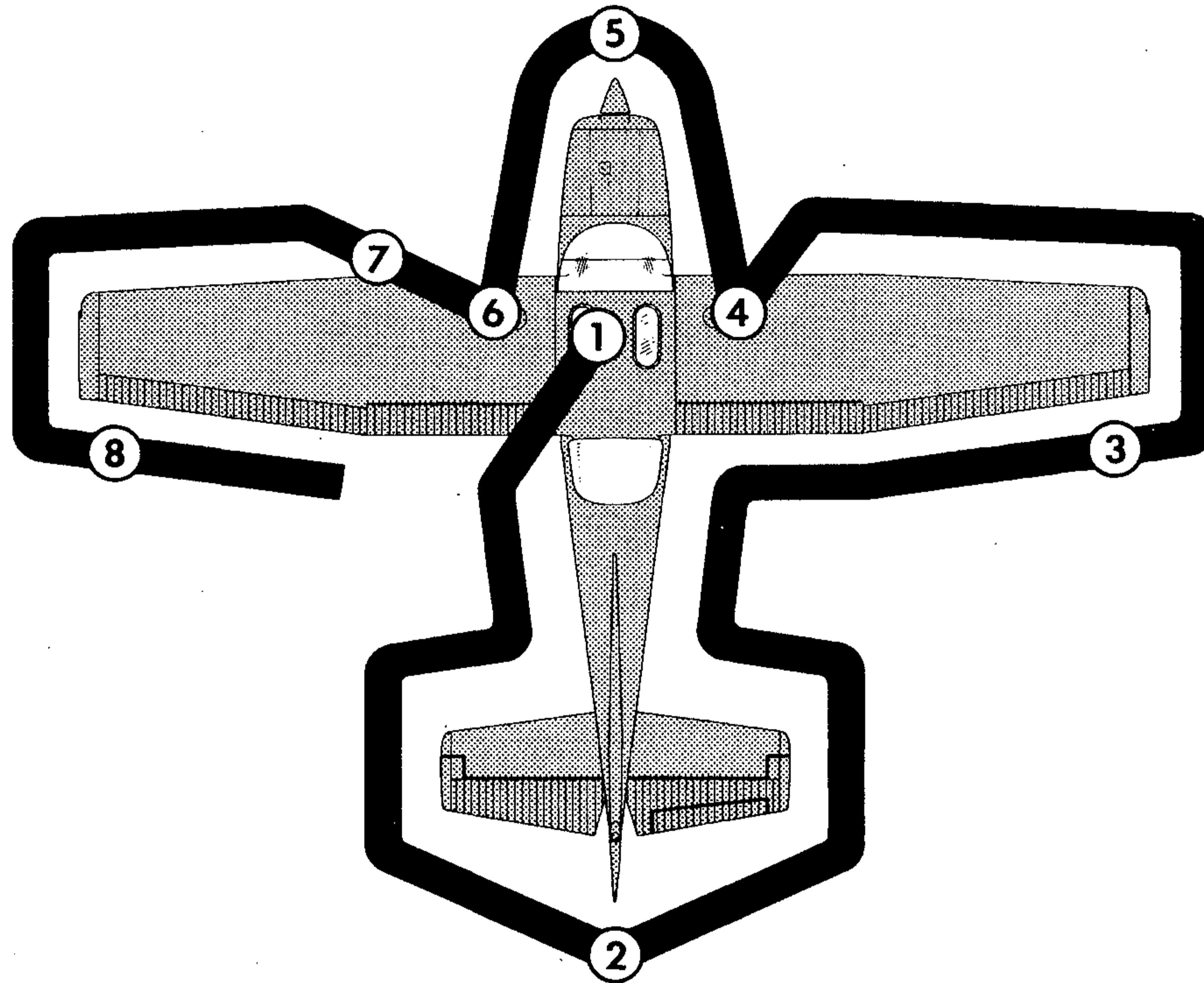

NOTE

Visually check airplane for general condition during walk-around inspection. In cold weather, remove even small accumulations of frost, ice or snow from wing, tail and control surfaces. Also, make sure that control surfaces contain no internal accumulations of ice or debris. Prior to flight, check that pitot heater (if installed) is warm to touch within 30 seconds with battery and pitot heat switches on. If a night flight is planned, check operation of all lights, and make sure a flashlight is available.

Figure 4-1. Preflight Inspection

## CHECKLIST PROCEDURES

### PREFLIGHT INSPECTION

#### ① CABIN

1. Landing Gear Lever -- DOWN.
2. Control Wheel Lock -- REMOVE.
3. Ignition Switch -- OFF.
4. Avionics Power Switch -- OFF.
5. Master Switch -- ON.
6. Fuel Quantity Indicators -- CHECK QUANTITY.
7. Landing Gear Position Indicator Light (green) -- ILLUMINATED.
8. Master Switch -- OFF.
9. Fuel Selector Valve -- BOTH.
10. Baggage Door -- CHECK for security, lock with key if child's seat is to be occupied.

#### ② EMPENNAGE

1. Rudder Gust Lock -- REMOVE.
2. Tail Tie-Down -- DISCONNECT.
3. Control Surfaces -- CHECK freedom of movement and security.

#### ③ RIGHT WING Trailing Edge

1. Aileron -- CHECK freedom of movement and security.

#### ④ RIGHT WING

1. Wing Tie-Down -- DISCONNECT.
2. Main Wheel Tire -- CHECK for proper inflation.
3. Before first flight of the day and after each refueling, use sampler cup and drain small quantity of fuel from fuel tank sump quick-drain valve to check for water, sediment, and proper fuel grade.
4. Fuel Quantity -- CHECK VISUALLY for desired level.
5. Fuel Filler Cap -- SECURE and vent unobstructed.

#### ⑤ NOSE

1. Static Source Openings (both sides of fuselage) --CHECK for stoppage.
2. Propeller and Spinner -- CHECK for nicks, security and oil leaks.
3. Landing Lights -- CHECK for condition and cleanliness.
4. Carburetor Air Inlet -- CHECK for restrictions .

5. Nose Wheel Strut and Tire -- CHECK for proper inflation.
6. Nose Tie-Down -- DISCONNECT.
7. Engine Oil Level -- CHECK. Do not operate with less than five quarts. Fill to eight quarts for extended flight.
8. Before first flight of the day and after each refueling, pull out strainer drain knob for about four seconds to clear fuel strainer of possible water and sediment. Check strainer drain closed. If water is observed, the fuel system may contain additional water, and further draining of the system at the strainer, fuel tank sumps, and fuel selector valve drain plug will be necessary.

#### ⑥ LEFT WING

1. Main Wheel Tire -- CHECK for proper inflation.
2. Before first flight of day and after each refueling, use sampler cup and drain small quantity of fuel from fuel tank sump quick-drain valve to check for water, sediment and proper fuel grade.
3. Fuel Quantity -- CHECK VISUALLY for desired level.
4. Fuel Filler Cap -- SECURE and vent unobstructed.

#### ⑦ LEFT WING Leading Edge

1. Pitot Tube Cover -- REMOVE and check opening for stoppage.
2. Fuel Tank Vent Opening -- CHECK for stoppage.
3. Stall Warning Vane -- CHECK for freedom of movement while master switch is momentarily turned ON (horn should sound when vane is pushed upward).
4. Wing Tie-Down -- DISCONNECT.

#### ⑧ LEFT WING Trailing Edge

1. Aileron -- CHECK freedom of movement and security.

### BEFORE STARTING ENGINE

1. Preflight Inspection -- COMPLETE.
2. Seats, Belts, Shoulder Harnesses -- ADJUST and LOCK.
3. Fuel Selector Valve -- BOTH.
4. Avionics Power Switch, Autopilot (if installed), Electrical Equipment -- OFF.

#### CAUTION

The avionics power switch must be OFF during engine start to prevent possible damage to avionics.

5. Brakes -- TEST and SET.
6. Cowl Flaps -- OPEN (move lever out of locking hole to reposition).
7. Landing Gear Lever -- DOWN
8. Circuit Breakers -- CHECK IN.

## STARTING ENGINE

1. Mixture -- RICH.
2. Propeller -- HIGH RPM.
3. Carburetor Heat -- COLD.
4. Throttle -- PUMP once, or as much as six times if engine is very hot; leave open 1/4 inch.
5. Master Switch -- ON.
6. Propeller Area -- CLEAR.
7. Ignition Switch -- START (release when engine starts).
8. Oil Pressure -- CHECK.

## BEFORE TAKEOFF

1. Cabin Doors and Windows -- CLOSED and LOCKED.
2. Parking Brake -- SET.
3. Flight Controls -- FREE and CORRECT.
4. Flight Instruments -- SET.
5. Fuel Selector Valve -- BOTH.
6. Mixture -- RICH.
7. Auxiliary Fuel Pump -- ON (check for rise in fuel pressure), then OFF.

### NOTE

In flight, gravity feed will normally supply satisfactory fuel flow if the engine-driven fuel pump should fail. However, if a fuel pump failure causes the fuel pressure to drop below 0.5 PSI, use the auxiliary fuel pump to assure proper engine operation.

8. Elevator and Rudder Trim -- TAKEOFF.
9. Throttle -- 1700 RPM.
  - a. Magnetos -- CHECK (RPM drop should not exceed 175 RPM on either magneto or 50 RPM differential between magnetos).
  - b. Propeller -- CYCLE from high to low RPM; return to high RPM (full in).
  - c. Carburetor Heat -- CHECK (for RPM drop).
  - d. Engine Instruments and Ammeter -- CHECK.
  - e. Suction Gage -- CHECK.

10. Avionics Power Switch -- ON.
11. Radios -- SET.
12. Autopilot (if installed) -- OFF.
13. Flashing Beacon, Navigation Lights and/or Strobe Lights -- ON as required.
14. Throttle Friction Lock -- ADJUST.
15. Parking Brake -- RELEASE.

## TAKEOFF

### NORMAL TAKEOFF

1. Wing Flaps -- 0° - 20°.
2. Carburetor Heat -- COLD.
3. Power -- FULL THROTTLE and 2400 RPM.
4. Elevator Control -- LIFT NOSE WHEEL at 50 KIAS.

#### NOTE

When the nose wheel is lifted, the gear motor may run 1-2 seconds to restore hydraulic pressure.

5. Climb Speed -- 70 KIAS (flaps 20°).  
80 KIAS (flaps UP).
6. Brakes -- APPLY momentarily when airborne.
7. Landing Gear -- RETRACT in climb out.
8. Wing Flaps -- RETRACT.

### SHORT FIELD TAKEOFF

1. Wing Flaps -- 20°.
2. Carburetor Heat -- COLD.
3. Brakes -- APPLY.
4. Power -- FULL THROTTLE and 2400 RPM.
5. Brakes -- RELEASE.
6. Elevator Control -- MAINTAIN SLIGHTLY TAIL-LOW ATTITUDE.
7. Climb Speed -- 55 KIAS until all obstacles are cleared.
8. Landing Gear -- RETRACT after obstacles are cleared.
9. Wing Flaps -- RETRACT slowly after reaching 75 KIAS.

## ENROUTE CLIMB

### NORMAL CLIMB

1. Airspeed -- 90-100 KIAS.



2. Power -- 23 INCHES Hg and 2400 RPM.
3. Fuel Selector Valve -- BOTH.
4. Mixture -- FULL RICH (mixture may be leaned above 3000 feet).
5. Cowl Flaps -- OPEN as required.

### MAXIMUM PERFORMANCE CLIMB

1. Airspeed -- 88 KIAS at sea level to 74 KIAS at 10,000 feet.
2. Power -- FULL THROTTLE and 2400 RPM.
3. Fuel Selector Valve -- BOTH.
4. Mixture -- FULL RICH (mixture may be leaned above 3000 feet).
5. Cowl Flaps -- FULL OPEN.

### CRUISE

1. Power -- 15-23 INCHES Hg, 2100-2400 RPM (no more than 75% power).
2. Elevator and Rudder Trim -- ADJUST.
3. Mixture -- LEAN.
4. Cowl Flaps -- CLOSED.

### DESCENT

1. Power -- AS DESIRED.
2. Carburetor Heat -- AS REQUIRED to prevent carburetor icing.
3. Mixture -- ENRICHEN as required.
4. Cowl Flaps -- CLOSED.
5. Wing Flaps -- AS DESIRED (0° - 10° below 140 KIAS, 10° - 40° below 95 KIAS).

#### NOTE

The landing gear may be used below 140 KIAS to increase the rate of descent.

### BEFORE LANDING

1. Seats, Belts, Shoulder Harnesses -- ADJUST and LOCK.
2. Fuel Selector Valve -- BOTH.
3. Landing Gear -- DOWN (below 140 KIAS).
4. Landing Gear -- CHECK (observe main gear down and green indicator light illuminated).
5. Mixture -- RICH.

6. Carburetor Heat -- ON (apply full heat before closing throttle).
7. Propeller -- HIGH RPM.
8. Autopilot (if installed) -- OFF.

## LANDING

### NORMAL LANDING

1. Airspeed -- 70-80 KIAS (flaps UP).
2. Wing Flaps -- AS DESIRED (0°- 10° below 140 KIAS, 10°-40° below 95 KIAS).
3. Airspeed -- 65-75 KIAS (flaps DOWN).
4. Trim -- ADJUST.
5. Touchdown -- MAIN WHEELS FIRST.
6. Landing Roll -- LOWER NOSE WHEEL GENTLY.
7. Braking -- MINIMUM REQUIRED.

### SHORT FIELD LANDING

1. Airspeed -- 70-80 KIAS (flaps UP).
2. Wing Flaps -- 40° (below 95 KIAS).
3. Airspeed -- MAINTAIN 63 KIAS.
4. Trim -- ADJUST.
5. Power -- REDUCE to idle as obstacle is cleared.
6. Touchdown -- MAIN WHEELS FIRST.
7. Brakes -- APPLY HEAVILY.
8. Wing Flaps -- RETRACT for maximum brake effectiveness.

### BALKED LANDING

1. Power -- FULL THROTTLE and 2400 RPM.
2. Carburetor Heat -- COLD.
3. Wing Flaps -- RETRACT to 20°.
4. Climb Speed -- 75 KIAS.
5. Wing Flaps -- RETRACT slowly after reaching 75 KIAS.
6. Cowl Flaps -- OPEN.

## AFTER LANDING

1. Wing Flaps -- UP.
2. Carburetor Heat -- COLD.
3. Cowl Flaps -- OPEN.

## SECURING AIRPLANE

1. Parking Brake -- SET.
2. Throttle -- IDLE.
3. Avionics Power Switch, Electrical Equipment -- OFF.
4. Mixture -- IDLE CUT-OFF (pulled full out).
5. Ignition Switch -- OFF.
6. Master Switch -- OFF.
7. Control Lock -- INSTALL.
8. Fuel Selector Valve -- RIGHT.



## AMPLIFIED PROCEDURES

### STARTING ENGINE

Ordinarily the engine starts easily with one or two pumps of the throttle in warm temperatures to six or eight pumps in cold weather with the mixture full rich. In extremely cold temperatures, it may be necessary to prime while cranking. Weak intermittent firing followed by puffs of black smoke from the exhaust stack indicates overpriming or flooding. Excess fuel can be cleared from the combustion chambers by the following procedure: Set the mixture control full lean and the throttle full open; then crank the engine through several revolutions with the starter. Repeat the starting procedure without any additional priming.

If the engine is underprimed (most likely in cold weather with a cold engine) it will not fire at all. Additional priming will be necessary for the next starting attempt. As soon as the cylinders begin to fire, open the throttle slightly to keep it running.

If prolonged cranking is necessary, allow the starter motor to cool at frequent intervals, since excessive heat may damage the armature.

After starting, if the oil gage does not begin to show pressure within 30 seconds in the summertime and about twice that long in very cold weather, stop engine and investigate. Lack of oil pressure can cause serious engine damage. After starting, avoid the use of carburetor heat unless icing conditions prevail.

#### NOTE

Additional details concerning cold weather starting and operation may be found under COLD WEATHER OPERATION paragraphs in this section.

### TAXIING

When taxiing, it is important that speed and use of brakes be held to a minimum and that all controls be utilized (see Taxiing Diagram, figure 4-2) to maintain directional control and balance.

The carburetor heat control knob should be pushed full in during all ground operations unless heat is absolutely necessary for smooth engine operation. When the knob is pulled out to the heat position, air entering the engine is not filtered.

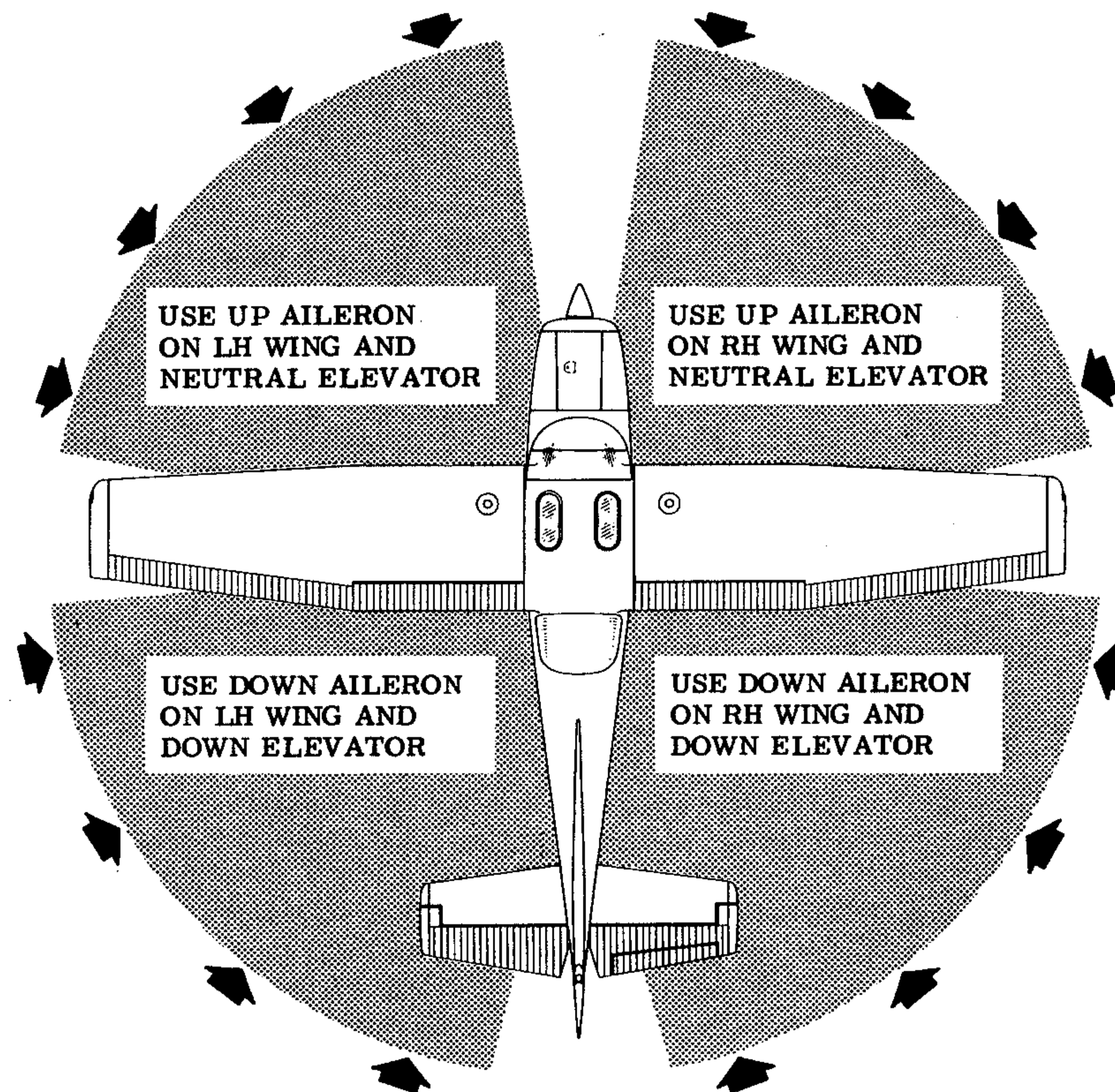

CODE  
WIND DIRECTION →

NOTE

Strong quartering tail winds require caution. Avoid sudden bursts of the throttle and sharp braking when the airplane is in this attitude. Use the steerable nose wheel and rudder to maintain direction.

Figure 4-2. Taxiing Diagram

Taxiing over loose gravel or cinders should be done at low engine speed to avoid abrasion and stone damage to the propeller tips.

## **BEFORE TAKEOFF**

### **WARM-UP**

Since the engine is closely cowled for efficient in-flight cooling, precautions should be taken to avoid overheating on the ground. Full power checks on the ground are not recommended unless the pilot has good reason to suspect that the engine is not turning up properly.

### **MAGNETO CHECK**

The magneto check should be made at 1700 RPM as follows. Move ignition switch first to R position and note RPM. Next move switch back to BOTH to clear the other set of plugs. Then move switch to the L position, note RPM and return the switch to the BOTH position. RPM drop should not exceed 175 RPM on either magneto or show greater than 50 RPM differential between magnetos. If there is a doubt concerning operation of the ignition system, RPM checks at higher engine speeds will usually confirm whether a deficiency exists.

An absence of RPM drop may be an indication of faulty grounding of one side of the ignition system or should be cause for suspicion that the magneto timing is set in advance of the setting specified.

### **ALTERNATOR CHECK**

Prior to flights where verification of proper alternator and voltage regulator operation is essential (such as night or instrument flights), a positive verification can be made by loading the electrical system momentarily (3 to 5 seconds) with the landing lights during the engine runup (1700 RPM). The ammeter will remain within a needle width of the initial reading if the alternator and voltage regulator are operating properly.

## **TAKEOFF**

### **POWER CHECK**

It is important to check takeoff power early in the takeoff run. Any sign of rough engine operation or sluggish engine acceleration is good cause for discontinuing the takeoff.

Full power runups over loose gravel are especially harmful to propeller tips. When takeoffs must be made over a gravel surface, it is very important that the throttle be advanced slowly. This allows the airplane to start rolling before high RPM is developed, and the gravel will be blown back of the propeller rather than pulled into it. When unavoidable small dents appear in the propeller blades they should be corrected immediately as described in Section 8 under Propeller Care.

After full power is applied, adjust the throttle friction lock clockwise to prevent the throttle from creeping from a maximum power position. Similar friction lock adjustment should be made as required in other flight conditions to maintain a fixed throttle setting.

### **WING FLAP SETTINGS**

Normal takeoffs are accomplished with wing flaps 0° to 20°. Using 20° wing flaps reduces the ground run and total distance over an obstacle by approximately 20 per cent. Flap deflections greater than 20° are not approved for takeoff.

If 20° wing flaps are used for takeoff, they should be left down until all obstacles are cleared and a safe flap retraction speed of 75 KIAS is reached. To clear an obstacle with wing flaps 20°, an obstacle clearance speed of 55 KIAS should be used.

Soft field takeoffs are performed with 20° flaps by lifting the airplane off the ground as soon as practical in a slightly tail-low attitude. If no obstacles are ahead, the airplane should be leveled off immediately to accelerate to a safer climb speed.

With wing flaps retracted and no obstructions ahead, a climb-out speed of 75 KIAS would be most efficient.

### **CROSSWIND TAKEOFF**

Takeoffs into strong crosswinds normally are performed with the minimum flap setting necessary for the field length, to minimize the drift angle immediately after takeoff. With the ailerons deflected partially into the wind, the airplane is accelerated to a speed slightly higher than normal, and then pulled off abruptly to prevent possible settling back to the runway while drifting. When clear of the ground, make a coordinated turn into the wind to correct for drift.

### **LANDING GEAR RETRACTION**

Landing gear retraction normally is started after reaching the point over the runway where a wheels-down, forced landing on that runway



would become impractical. Since the landing gear swings downward approximately two feet as it starts the retraction cycle, damage can result by retracting it before obtaining at least that much ground clearance.

Before retracting the landing gear, the brakes should be applied momentarily to stop wheel rotation. Centrifugal force caused by the rapidly-spinning wheel expands the diameter of the tire. If there is an accumulation of mud or ice in the wheel wells, the rotating wheel may rub as it is retracted into the wheel well.

## ENROUTE CLIMB

Normal climbs are performed at 90-100 KIAS with flaps up, 23 In. Hg. or full throttle (whichever is less) and 2400 RPM for the best combination of engine cooling, rate of climb and forward visibility. If it is necessary to climb rapidly to clear mountains or reach favorable winds at high altitudes, the best rate-of-climb speed should be used with maximum power. This speed is 88 KIAS at sea level, decreasing to 74 KIAS at 10,000 feet.

If an obstruction ahead requires a steep climb angle, a best angle-of-climb speed should be used with landing gear and flaps up and maximum power. This speed is 64 KIAS at sea level, increasing to 66 KIAS at 10,000 feet.

The mixture should be full rich during climb at altitudes up to 3000 feet. Above 3000 feet, a full rich mixture setting may be used or the mixture may be leaned for increased power. Also, the mixture may be leaned as required for smooth engine operation. With the optional Cessna Economy Mixture Indicator, the mixture may be leaned to maintain the EGT indication corresponding to full rich at 3000 feet. This procedure will significantly improve high altitude climb performance.

## CRUISE

Normal cruising is performed between 55% and 75% power. The corresponding power settings and fuel consumption for various altitudes can be determined by using your Cessna Power Computer or the data in Section 5.

### NOTE

Cruising should be done at 75% power as much as practical until a total of 50 hours has accumulated or oil consumption has stabilized. This is to ensure proper seating of the

rings and is applicable to new engines, and engines in service following cylinder replacement or top overhaul of one or more cylinders.

The Cruise Performance Table, figure 4-3, illustrates the true airspeed and nautical miles per gallon during cruise for various altitudes and percent powers. This table should be used as a guide, along with the available winds aloft information, to determine the most favorable altitudes and power setting for a given trip. The selection of cruise altitude on the basis of the most favorable wind conditions and the use of low power settings are significant factors that should be considered on every trip to reduce fuel consumption.

For reduced noise levels, it is desirable to select the lowest RPM in the green arc range for a given percent power that will provide smooth engine operation. The cowl flaps should be opened, if necessary, to maintain the cylinder head temperature at approximately two-thirds of the normal operating range (green arc).

Cruise performance data in this handbook and on the power computer is based on a recommended lean mixture setting which may be established as follows:

1. Lean the mixture until the engine becomes rough.
2. Enrichen the mixture to obtain smooth engine operation; then further enrichen an equal amount.

For best fuel economy at 75% power or less, the engine may be operated at the leanest mixture that results in smooth engine operation. This will result in approximately 6% greater range than shown in this handbook accompanied by approximately 3 knots decrease in speed.

ALTITUDE	75% POWER		65% POWER		55% POWER	
	KTAS	NMPG	KTAS	NMPG	KTAS	NMPG
2500	148	11.0	140	11.9	131	13.0
5000	152	11.2	143	12.2	134	13.3
7500	156	11.5	147	12.5	136	13.5
10,000	---	---	150	12.8	139	13.8
Standard Conditions					Zero Wind	

Figure 4-3. Cruise Performance Table

Any change in altitude, power or carburetor heat will require a change in the recommended lean mixture setting and a recheck of the EGT setting (if installed).

Carburetor ice, as evidenced by an unexplained drop in manifold pressure, can be removed by application of full carburetor heat. Upon regaining the original manifold pressure indication (with heat off), use the minimum amount of heat (by trial and error) to prevent ice from forming. Since the heated air causes a richer mixture, readjust the mixture setting when carburetor heat is to be used continuously in cruise flight.

### LEANING WITH A CESSNA ECONOMY MIXTURE INDICATOR (EGT)

Exhaust gas temperature (EGT) as shown on the optional Cessna Economy Mixture Indicator may be used as an aid for mixture leaning in cruising flight at 75% power or less. To adjust the mixture, using this indicator, lean to establish the peak EGT as a reference point and then enrichen the mixture by a desired increment based on data in figure 4-4.

As noted in the table, operation at peak EGT provides best fuel economy. This results in approximately 6% greater range than shown in this handbook accompanied by approximately 3 knots decrease in speed.

When leaning the mixture under some conditions, engine roughness may occur before peak EGT is reached. In this case, use the EGT corresponding to the onset of roughness as the reference point instead of peak EGT.

MIXTURE DESCRIPTION	EXHAUST GAS TEMPERATURE
RECOMMENDED LEAN (Pilot's Operating Handbook and Power Computer)	50°F Rich of Peak EGT
BEST ECONOMY	Peak EGT

Figure 4-4. EGT Table

## **STALLS**

The stall characteristics are conventional and aural warning is provided by a stall warning horn which sounds between 5 and 10 knots above the stall in all configurations.

Power-off stall speeds at maximum weight for both forward and aft C.G. positions are presented in Section 5.

## **BEFORE LANDING**

In view of the relatively low drag of the extended landing gear and the high allowable gear operating speed (140 KIAS), the landing gear should be extended before entering the traffic pattern. This practice will allow more time to confirm that the landing gear is down and locked. As a further precaution, leave the landing gear extended in go-around procedures or traffic patterns for touch-and-go landings.

Landing gear extension can be detected by illumination of the gear down indicator light (green), absence of a gear warning horn with the throttle retarded below 12 inches of manifold pressure and/or the wing flaps extended beyond 25°, and visual inspection of the main gear position. Should the gear indicator light fail to illuminate, the light should be checked for a burned-out bulb by pushing to test. A burned-out bulb can be replaced in flight with the landing gear up (amber) indicator light.

## **LANDING**

### **NORMAL LANDING**

Landings should be made on the main wheels first to reduce the landing speed and the subsequent need for braking in the landing roll. The nose wheel is lowered gently to the runway after the speed has diminished to avoid unnecessary nose gear load. This procedure is especially important in rough field landings.

### **SHORT FIELD LANDING**

For a short field landing, make a power-off approach at 63 KIAS with 40° flaps and land on the main wheels first. Immediately after touchdown, lower the nose gear to the ground and apply heavy braking as required. For maximum brake effectiveness after all three wheels are on the ground, retract the flaps, hold full nose up elevator and apply maximum possible brake pressure without sliding the tires.

## **CROSSWIND LANDING**

When landing in a strong crosswind, use the minimum flap setting required for the field length. Although the crab or combination method of drift correction may be used, the wing-low method gives the best control. After touchdown, hold a straight course with the steerable nose wheel and occasional braking if necessary.

## **BALKED LANDING**

In a balked landing (go-around) climb, the wing flap setting should be reduced to 20° immediately after full power is applied. After all obstacles are cleared and a safe altitude and airspeed are obtained, the wing flaps should be retracted.

## **COLD WEATHER OPERATION**

### **STARTING**

Prior to starting on cold mornings, it is advisable to pull the propeller through several times by hand to "break loose" or "limber" the oil, thus conserving battery energy.

#### **NOTE**

When pulling the propeller through by hand, treat it as if the ignition switch is turned on. A loose or broken ground wire on either magneto could cause the engine to fire.

In extremely cold (-18°C and lower) weather, the use of an external pre-heater and an external power source are recommended whenever possible to obtain positive starting and to reduce wear and abuse to the engine and the electrical system. Pre-heat will thaw the oil trapped in the oil cooler, which probably will be congealed prior to starting in extremely cold temperatures. When using an external power source, the position of the master switch is important. Refer to Section 7, paragraph Ground Service Plug Receptacle, for operating details.

Cold weather starting procedures are as follows:

#### **With Preheat:**

1. With ignition switch turned off, mixture full rich and throttle open 1/2 inch, prime the engine four to eight strokes.

NOTE

Use heavy strokes of the primer for best atomization of fuel. After priming, push primer all the way in and turn to the locked position to avoid the possibility of the engine drawing fuel through the primer.

2. Propeller -- CLEAR.
3. Avionics Power Switch -- OFF.
4. Master Switch -- ON.
5. Throttle -- PUMP several times.
6. Ignition Switch -- START (release to BOTH when engine starts).

**Without Preheat:**

1. Prime the engine five to six strokes with mixture full rich and throttle open 1/2 inch. Leave the primer charged and ready for a stroke.
2. Propeller -- CLEAR.
3. Avionics Power Switch -- OFF.
4. Master Switch -- ON.
5. Pump throttle rapidly to full open four times. Return to 1/2 inch open position.
6. Ignition Switch -- START.
7. Release ignition switch to BOTH when engine starts.
8. Continue to prime engine until it is running smoothly, or alternately, pump the throttle rapidly over first 1/4 of total travel.
9. Oil Pressure -- CHECK.
10. Primer -- LOCK.

NOTE

If the engine does not start during the first few attempts, or if engine firing diminishes in strength, it is probable that the spark plugs have been frosted over. Preheat must be used before another start is attempted.

**CAUTION**

Excessive pumping of the throttle may cause raw fuel to accumulate in the intake manifold, creating a fire hazard in the event of a backfire. If this occurs, maintain a cranking action to suck flames into the engine. An outside attendant with a fire extinguisher is advised for cold starts without preheat.

## OPERATION

During cold weather operations, no indication will be apparent on the oil temperature gage prior to takeoff if outside air temperatures are very cold. After a suitable warm-up period (2 to 5 minutes at 1000 RPM), accelerate the engine several times to higher engine RPM. If the engine accelerates smoothly and the oil pressure remains normal and steady, the airplane is ready for takeoff.

Rough engine operation in cold weather can be caused by a combination of an inherently leaner mixture due to the dense air and poor vaporization and distribution of the fuel-air mixture to the cylinders. The effects of these conditions are especially noticeable during operation on one magneto in ground checks where only one spark plug fires in each cylinder.

For optimum operation of the engine in cold weather, the appropriate use of carburetor heat may be necessary. The following procedures are indicated as a guideline:

1. Use the minimum carburetor heat required for smooth operation in takeoff, climb, and cruise.

### NOTE

Care should be exercised when using partial carburetor heat to avoid icing. Partial heat may raise the carburetor air temperature to 0° to 21°C range where icing is critical under certain atmospheric conditions.

2. If the airplane is equipped with a carburetor air temperature gage, it can be used as a reference in maintaining carburetor air temperature at or slightly above the top of the yellow arc by application of carburetor heat.

## HOT WEATHER OPERATION

The general warm temperature starting information in this section is appropriate. Avoid prolonged engine operation on the ground.

## NOISE ABATEMENT

Increased emphasis on improving the quality of our environment requires renewed effort on the part of all pilots to minimize the effect of airplane noise on the public.

We, as pilots, can demonstrate our concern for environmental improvement, by application of the following suggested procedures, and thereby tend to build public support for aviation:

1. Pilots operating aircraft under VFR over outdoor assemblies of persons, recreational and park areas, and other noise-sensitive areas should make every effort to fly not less than 2000 feet above the surface, weather permitting, even though flight at a lower level may be consistent with the provisions of government regulations.
2. During departure from or approach to an airport, climb after takeoff and descent for landing should be made so as to avoid prolonged flight at low altitude near noise-sensitive areas.

**NOTE**

The above recommended procedures do not apply where they would conflict with Air Traffic Control clearances or instructions, or where, in the pilot's judgment, an altitude of less than 2000 feet is necessary for him to adequately exercise his duty to see and avoid other aircraft.

The certificated noise level for the Model R182 at 3100 pounds maximum weight is 70.7 dB(A). No determination has been made by the Federal Aviation Administration that the noise levels of this airplane are or should be acceptable or unacceptable for operation at, into, or out of, any airport.



# SECTION 5 PERFORMANCE

## TABLE OF CONTENTS

	Page
Introduction . . . . .	5-3
Use of Performance Charts . . . . .	5-3
Sample Problem . . . . .	5-3
Takeoff . . . . .	5-4
Cruise . . . . .	5-5
Fuel Required . . . . .	5-5
Landing . . . . .	5-7
Figure 5-1, Airspeed Calibration - Normal Static Source . . . . .	5-8
Airspeed Calibration - Alternate Static Source . . . . .	5-9
Figure 5-2, Temperature Conversion Chart . . . . .	5-10
Figure 5-3, Stall Speeds . . . . .	5-11
Figure 5-4, Takeoff Distance - 3100 Lbs . . . . .	5-12
Takeoff Distance - 2800 Lbs And 2500 Lbs . . . . .	5-13
Figure 5-5, Rate Of Climb - Maximum . . . . .	5-14
Figure 5-6, Time, Fuel, And Distance To Climb - Maximum Rate Of Climb . . . . .	5-15
Time, Fuel, And Distance To Climb - Normal Climb . . . . .	5-16
Figure 5-7, Cruise Performance - 2000 Feet . . . . .	5-17
Cruise Performance - 4000 Feet . . . . .	5-18
Cruise Performance - 6000 Feet . . . . .	5-19
Cruise Performance - 8000 Feet . . . . .	5-20
Cruise Performance - 10,000 Feet . . . . .	5-21
Cruise Performance - 12,000 Feet . . . . .	5-22
Figure 5-8, Range Profile - 56 Gallons Fuel . . . . .	5-23
Range Profile - 75 Gallons Fuel . . . . .	5-24
Figure 5-9, Endurance Profile - 56 Gallons Fuel . . . . .	5-25
Endurance Profile - 75 Gallons Fuel . . . . .	5-26
Figure 5-10, Landing Distance . . . . .	5-27



## INTRODUCTION

Performance data charts on the following pages are presented so that you may know what to expect from the airplane under various conditions, and also, to facilitate the planning of flights in detail and with reasonable accuracy. The data in the charts has been computed from actual flight tests with the airplane and engine in good condition and using average piloting techniques.

It should be noted that the performance information presented in the range and endurance profile charts allows for 45 minutes reserve fuel based on 45% power. Fuel flow data for cruise is based on the recommended lean mixture setting. Some indeterminate variables such as mixture leaning technique, fuel metering characteristics, engine and propeller condition, and air turbulence may account for variations of 10% or more in range and endurance. Therefore, it is important to utilize all available information to estimate the fuel required for the particular flight.

## USE OF PERFORMANCE CHARTS

Performance data is presented in tabular or graphical form to illustrate the effect of different variables. Sufficiently detailed information is provided in the tables so that conservative values can be selected and used to determine the particular performance figure with reasonable accuracy.

## SAMPLE PROBLEM

The following sample flight problem utilizes information from the various charts to determine the predicted performance data for a typical flight. The following information is known:

### AIRPLANE CONFIGURATION

Takeoff weight	3050 Pounds
Usable fuel	75 Gallons

### TAKEOFF CONDITIONS

Field pressure altitude	1500 Feet
Temperature	28°C (16°C above standard)
Wind component along runway	12 Knot Headwind
Field length	3500 Feet

**CRUISE CONDITIONS**

Total distance	720 Nautical Miles
Pressure altitude	7500 Feet
Temperature	16°C (16°C above standard)
Expected wind enroute	10 Knot Headwind

**LANDING CONDITIONS**

Field pressure altitude	2000 Feet
Temperature	25°C
Field length	3000 Feet

**TAKEOFF**

The takeoff distance chart, figure 5-4, should be consulted, keeping in mind that the distances shown are based on the short field technique. Conservative distances can be established by reading the chart at the next higher value of weight, altitude and temperature. For example, in this particular sample problem, the takeoff distance information presented for a weight of 3100 pounds, pressure altitude of 2000 feet and a temperature of 30°C should be used and results in the following:

Ground roll	1085 Feet
Total distance to clear a 50-foot obstacle	2110 Feet

These distances are well within the available takeoff field length. However, a correction for the effect of wind may be made based on Note 3 of the takeoff chart. The correction for a 12 knot headwind is:

$$\frac{12 \text{ Knots}}{9 \text{ Knots}} \times 10\% = 13\% \text{ Decrease}$$

This results in the following distances, corrected for wind:

Ground roll, zero wind	1085
Decrease in ground roll (1085 feet × 13%)	<u>141</u>
Corrected ground roll	944 Feet
Total distance to clear a 50-foot obstacle, zero wind	2110
Decrease in total distance (2110 feet × 13%)	<u>274</u>
Corrected total distance to clear 50-foot obstacle	1836 Feet

## CRUISE

The cruising altitude should be selected based on a consideration of trip length, winds aloft, and the airplane's performance. A cruising altitude and the expected wind enroute have been given for this sample problem. However, the power setting selection for cruise must be determined based on several considerations. These include the cruise performance characteristics presented in figure 5-7, the range profile chart presented in figure 5-8, and the endurance profile chart presented in figure 5-9.

The relationship between power and range is illustrated by the range profile chart. Considerable fuel savings and longer range result when lower power settings are used.

The range profile chart indicates that use of 65% power at 7500 feet yields a predicted range of 802 nautical miles with no wind. The endurance profile chart shows a corresponding 5.5 hours. Using this information, the estimated distance can be determined for the expected 10 knot headwind at 7500 feet as follows:

Range, zero wind	802
Decrease in range due to wind (5.5 hours × 10 knot headwind)	55
Corrected range	<u>747</u> Nautical Miles

This indicates that the trip can be made without a fuel stop using approximately 65% power.

The cruise performance chart for 8000 feet pressure altitude is entered using 20°C above standard temperature. These values most nearly correspond to the planned altitude and expected temperature conditions. The power setting chosen is 2200 RPM and 21 inches of manifold pressure, which results in the following:

Power	65%
True airspeed	150 Knots
Cruise fuel flow	11.7 GPH

The power computer may be used to determine power and fuel consumption more accurately during the flight.

## FUEL REQUIRED

The total fuel requirement for the flight may be estimated using the performance information in figures 5-6 and 5-7. For this sample problem, figure 5-6 shows that a normal climb from 2000 feet to 8000 feet requires 3.4

gallons of fuel. The corresponding distance during the climb is 16 nautical miles. These values are for a standard temperature and are sufficiently accurate for most flight planning purposes. However, a further correction for the effect of temperature may be made as noted on the climb chart. The approximate effect of a non-standard temperature is to increase the time, fuel, and distance by 10% for each 10°C above standard temperature, due to the lower rate of climb. In this case, assuming a temperature 16°C above standard, the correction would be:

$$\frac{16^{\circ}\text{C}}{10^{\circ}\text{C}} \times 10\% = 16\% \text{ Increase}$$

With this factor included, the fuel estimate would be calculated as follows:

Fuel to climb, standard temperature	3.4
Increase due to non-standard temperature (3.4 × 16%)	<u>0.5</u>
Corrected fuel to climb	3.9 Gallons

Using a similar procedure for the distance during climb results in 19 nautical miles.

The resultant cruise distance is:

Total distance	720
Climb distance	<u>-19</u>
Cruise distance	701 Nautical Miles

With an expected 10 knot headwind, the ground speed for cruise is predicted to be:

$$\begin{array}{r} 150 \\ -10 \\ \hline 140 \text{ Knots} \end{array}$$

Therefore, the time required for the cruise portion of the trip is:

$$\frac{701 \text{ Nautical Miles}}{140 \text{ Knots}} = 5.0 \text{ Hours}$$

The fuel required for cruise is:

$$5.0 \text{ hours} \times 11.7 \text{ gallons/hour} = 58.5 \text{ Gallons}$$

The total estimated fuel required is as follows:

Engine start, taxi, and takeoff	2.0
Climb	3.9
Cruise	<u>58.5</u>
Total fuel required	64.4 Gallons

This will leave a fuel reserve of:

75.0
<u>-64.4</u>
10.6 Gallons

Once the flight is underway, ground speed checks will provide a more accurate basis for estimating the time enroute and the corresponding fuel required to complete the trip with ample reserve.

## LANDING

A procedure similar to takeoff should be used for estimating the landing distance at the destination airport. Figure 5-10 presents landing distance information for the short field technique. The distances corresponding to 2000 feet pressure altitude and a temperature of 30°C are as follows:

Ground roll	680 Feet
Total distance to clear a 50-foot obstacle	1450 Feet

A correction for the effect of wind may be made based on Note 2 of the landing chart using the same procedure as outlined for takeoff.

**AIRSPEED CALIBRATION**  
**NORMAL STATIC SOURCE**

<b>FLAPS UP</b>														
<b>KIAS</b>	50	60	70	80	90	100	110	120	130	140	150	160	170	
<b>KCAS</b>	60	66	73	81	90	99	109	118	128	137	146	155	165	
<b>FLAPS 20°</b>														
<b>KIAS</b>	40	50	60	70	80	90	95	---	---	---	---	---	---	---
<b>KCAS</b>	54	59	65	73	81	90	95	---	---	---	---	---	---	---
<b>FLAPS 40°</b>														
<b>KIAS</b>	40	50	60	70	80	90	95	---	---	---	---	---	---	---
<b>KCAS</b>	53	58	65	73	81	91	96	---	---	---	---	---	---	---

Figure 5-1. Airspeed Calibration (Sheet 1 of 2)



## AIRSPEED CALIBRATION

### ALTERNATE STATIC SOURCE

#### HEATER/VENTS AND WINDOWS CLOSED

FLAPS UP												
NORMAL KIAS	60	70	80	90	100	110	120	130	140	150	160	
ALTERNATE KIAS	62	72	83	93	103	113	123	133	143	153	163	
FLAPS 20°												
NORMAL KIAS	50	60	70	80	90	95	---	---	---	---	---	---
ALTERNATE KIAS	51	62	73	84	94	99	---	---	---	---	---	---
FLAPS 40°												
NORMAL KIAS	40	50	60	70	80	90	95	---	---	---	---	---
ALTERNATE KIAS	39	51	62	73	82	92	96	---	---	---	---	---

#### HEATER/VENTS OPEN AND WINDOWS CLOSED

FLAPS UP												
NORMAL KIAS	60	70	80	90	100	110	120	130	140	150	160	
ALTERNATE KIAS	60	70	81	90	100	110	120	129	139	149	159	
FLAPS 20°												
NORMAL KIAS	50	60	70	80	90	95	---	---	---	---	---	---
ALTERNATE KIAS	50	61	71	81	91	96	---	---	---	---	---	---
FLAPS 40°												
NORMAL KIAS	40	50	60	70	80	90	95	---	---	---	---	---
ALTERNATE KIAS	38	48	58	69	78	88	93	---	---	---	---	---

Figure 5-1. Airspeed Calibration (Sheet 2 of 2)

## TEMPERATURE CONVERSION CHART

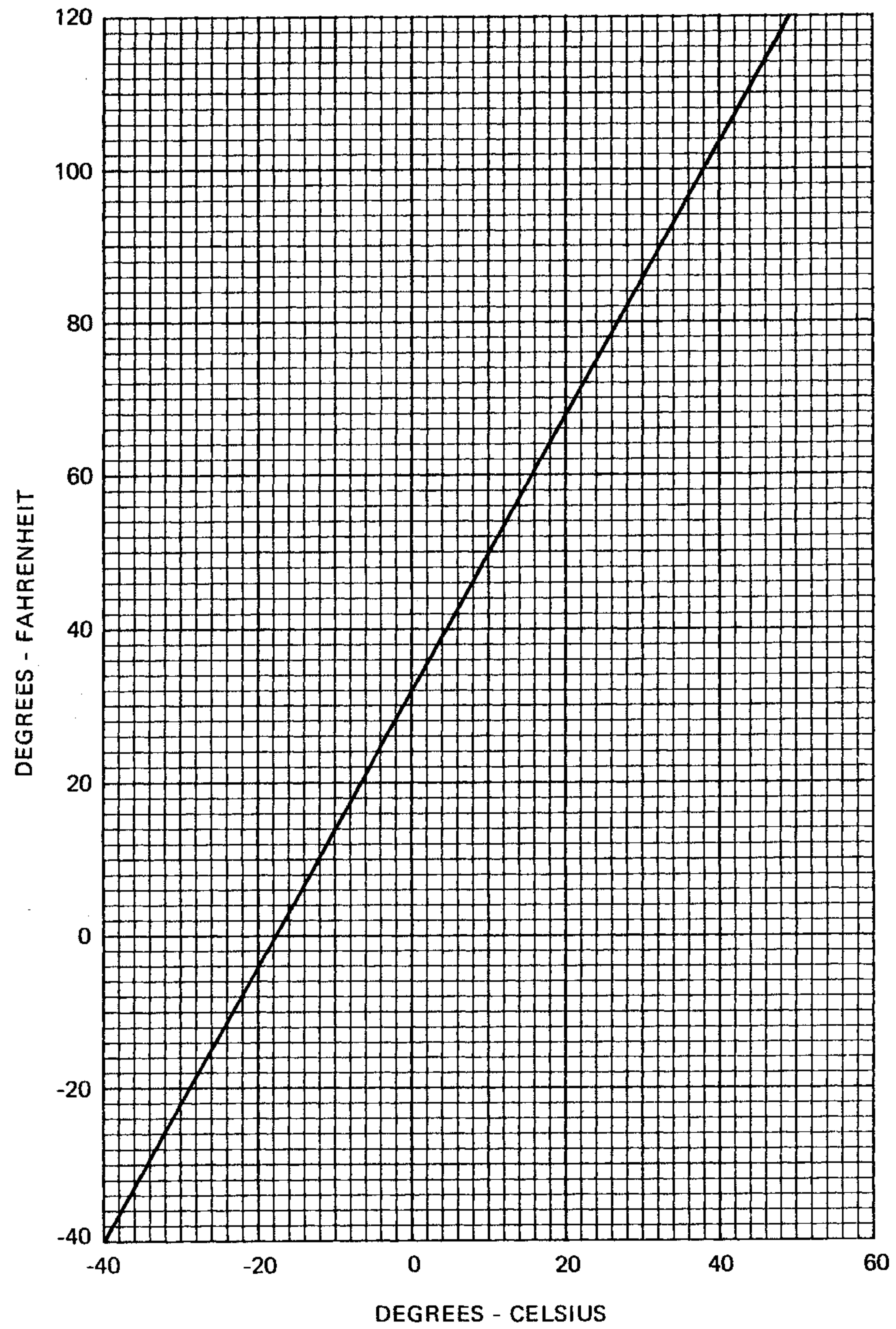

Figure 5-2. Temperature Conversion Chart

## STALL SPEEDS

CONDITIONS:  
Power Off

NOTES:

1. Maximum altitude loss during a stall recovery may be as much as 240 feet.
2. KIAS values are approximate.

### MOST REARWARD CENTER OF GRAVITY

WEIGHT LBS	FLAP DEFLECTION	ANGLE OF BANK							
		0°		30°		45°		60°	
		KIAS	KCAS	KIAS	KCAS	KIAS	KCAS	KIAS	KCAS
3100	UP	40	54	43	58	48	64	57	76
	20°	38	51	41	55	46	61	55	72
	40°	35	50	38	54	43	59	52	71

### MOST FORWARD CENTER OF GRAVITY

WEIGHT LBS	FLAP DEFLECTION	ANGLE OF BANK							
		0°		30°		45°		60°	
		KIAS	KCAS	KIAS	KCAS	KIAS	KCAS	KIAS	KCAS
3100	UP	42	55	45	59	50	65	59	78
	20°	40	52	41	56	46	62	55	74
	40°	37	52	40	56	45	62	54	74

Figure 5-3. Stall Speeds

**TAKEOFF DISTANCE**  
**MAXIMUM WEIGHT 3100 LBS**

**SHORT FIELD**

CONDITIONS:

Flaps 20°  
2400 RPM and Full Throttle Prior to Brake Release  
Cowl Flaps Open  
Paved, Level, Dry Runway  
Zero Wind

NOTES:

1. Short field technique as specified in Section 4.
2. Prior to takeoff from fields above 3000 feet elevation, the mixture should be leaned to give maximum power in a full throttle, static runup.
3. Decrease distances 10% for each 9 knots headwind. For operation with tailwinds up to 10 knots, increase distances by 10% for each 2 knots.
4. Where distance value has been deleted, climb performance after lift-off is less than 150 fpm at takeoff speed.
5. For operation on a dry, grass runway, increase distances by 15% of the "ground roll" figure.

WEIGHT LBS	TAKEOFF SPEED KIAS		PRESS ALT FT	0°C			10°C			20°C			30°C			40°C				
	LIFT OFF	AT 50 FT		GRND ROLL	TO CLEAR 50 FT OBS	TOTAL	GRND ROLL	TO CLEAR 50 FT OBS	TOTAL	GRND ROLL	TO CLEAR 50 FT OBS	TOTAL	GRND ROLL	TO CLEAR 50 FT OBS	TOTAL	GRND ROLL	TO CLEAR 50 FT OBS	TOTAL		
3100	47	55	S.L.	735	1410	790	1515	1625	910	1745	1870	850	1660	1785	995	1915	2060	975	1870	
			1000	800	1545	860	1660	1785	995	1915	2060	975	1870	850	1660	1785	995	1915	2060	
			2000	875	1690	940	1820	1960	1085	2110	2275	1165	2275	1010	1960	1960	1085	2110	2275	2275
			3000	955	1860	1030	2010	2165	1190	2340	2525	1275	2525	1105	2165	2340	1190	2340	2525	2525
			4000	1045	2055	1125	2225	2405	1300	2605	2825	1395	2825	1210	2405	2605	1300	2605	2825	2825
			5000	1145	2280	1235	2475	2690	1430	2925	3185	1535	3185	1330	2690	2925	1430	2925	3185	3185
			6000	1255	2550	1355	2775	3030	1570	3310	3635	1685	3635	1460	3030	3310	1570	3310	3635	3635
			7000	1380	2870	1490	3140	3450	1730	3805	---	---	---	---	1605	3450	3805	---	---	---
8000	1520	3260	1640	3600	3990	1770	---	---	---	---	---	1770	3990	---	---	---	---	---		

Figure 5-4. Takeoff Distance (Sheet 1 of 2)

**TAKEOFF DISTANCE  
2800 LBS AND 2500 LBS**

**SHORT FIELD**

REFER TO SHEET 1 FOR APPROPRIATE CONDITIONS AND NOTES.

WEIGHT LBS	TAKEOFF SPEED KIAS		PRESS ALT. FT	0°C		10°C		20°C		30°C		40°C	
	LIFT OFF	AT 50 FT		GRND ROLL	TOTAL TO CLEAR 50 FT OBS	GRND ROLL	TOTAL TO CLEAR 50 FT OBS	GRND ROLL	TOTAL TO CLEAR 50 FT OBS	GRND ROLL	TOTAL TO CLEAR 50 FT OBS	GRND ROLL	TOTAL TO CLEAR 50 FT OBS
2800	45	53	S.L.	580	1115	625	1195	670	1275	720	1365	770	1460
			1000	635	1215	680	1300	730	1395	785	1490	840	1595
			2000	690	1325	745	1420	800	1520	855	1630	915	1750
			3000	755	1445	810	1555	870	1670	935	1790	1000	1920
			4000	820	1585	885	1705	950	1835	1020	1975	1095	2125
			5000	900	1745	970	1880	1040	2025	1120	2185	1200	2355
			6000	985	1925	1060	2080	1140	2250	1225	2430	1315	2630
			7000	1080	2140	1165	2315	1255	2510	1350	2725	1450	2960
8000	1185	2385	1280	2595	1380	2825	1485	3080	1595	3365			
2500	42	50	S.L.	450	870	485	925	520	990	555	1055	595	1125
			1000	490	940	525	1005	565	1075	605	1145	645	1220
			2000	530	1020	570	1090	615	1165	660	1245	705	1330
			3000	580	1110	625	1190	670	1270	720	1360	770	1455
			4000	630	1210	680	1300	730	1390	785	1490	840	1590
			5000	690	1325	745	1420	800	1525	855	1635	915	1750
			6000	755	1450	810	1560	875	1675	935	1800	1005	1930
			7000	825	1595	890	1715	955	1850	1025	1990	1100	2140
8000	905	1760	975	1900	1050	2050	1130	2210	1210	2385			

Figure 5-4. Takeoff Distance (Sheet 2 of 2)

## RATE OF CLIMB

### MAXIMUM

**CONDITIONS:**

Flaps Up  
Gear Up  
2400 RPM  
Full Throttle  
Mixture Full Rich  
Cowl Flaps Open

**NOTE:**

Mixture may be leaned above 3000 feet for increased power.

WEIGHT LBS	PRESS ALT FT	CLIMB SPEED KIAS	RATE OF CLIMB - FPM			
			-20°C	0°C	20°C	40°C
3100	S.L.	88	1270	1195	1120	1045
	2000	85	1110	1035	960	890
	4000	82	945	875	805	730
	6000	80	785	715	645	570
	8000	77	625	555	485	415
	10,000	74	465	395	325	---
	12,000	72	305	235	165	---

Figure 5-5. Rate of Climb

## TIME, FUEL, AND DISTANCE TO CLIMB

### MAXIMUM RATE OF CLIMB

**CONDITIONS:**

Flaps Up  
Gear Up  
2400 RPM  
Full Throttle  
Mixture Full Rich  
Cowl Flaps Open  
Standard Temperature

**NOTES:**

1. Add 2.0 gallons of fuel for engine start, taxi and takeoff allowance.
2. Mixture may be leaned above 3000 feet for increased power.
3. Increase time, fuel and distance by 10% for each 10°C above standard temperature.
4. Distances shown are based on zero wind.

WEIGHT LBS	PRESSURE ALTITUDE FT	TEMP °C	CLIMB SPEED KIAS	RATE OF CLIMB FPM	FROM SEA LEVEL		
					TIME MIN	FUEL USED GALLONS	DISTANCE NM
3100	S.L.	15	88	1140	0	0	0
	1000	13	86	1065	1	0.4	1
	2000	11	85	995	2	0.8	3
	3000	9	84	920	3	1.2	4
	4000	7	82	850	4	1.6	6
	5000	5	81	775	5	2.1	8
	6000	3	80	705	7	2.6	10
	7000	1	78	630	8	3.1	12
	8000	-1	77	560	10	3.7	15
	9000	-3	76	485	12	4.4	18
	10,000	-5	74	415	14	5.1	21
	11,000	-7	73	340	17	6.0	25
	12,000	-9	72	265	20	7.1	30

Figure 5-6. Time, Fuel, and Distance to Climb (Sheet 1 of 2)

## TIME, FUEL, AND DISTANCE TO CLIMB

### NORMAL CLIMB - 95 KIAS

CONDITIONS:

Flaps Up  
Gear Up  
2400 RPM  
23 Inches Hg or Full Throttle  
Mixture Full Rich  
Cowl Flaps Open  
Standard Temperature

NOTES:

1. Add 2.0 gallons of fuel for engine start, taxi and takeoff allowance.
2. Mixture may be leaned above 3000 feet for increased power.
3. Increase time, fuel and distance by 10% for each 10°C above standard temperature.
4. Distances shown are based on zero wind.

WEIGHT LBS	PRESSURE ALTITUDE FT	TEMP °C	RATE OF CLIMB FPM	FROM SEA LEVEL		
				TIME MIN	FUEL USED GALLONS	DISTANCE NM
3100	S.L.	15	680	0	0	0
	1000	13	680	1	0.5	2
	2000	11	680	3	1.0	5
	3000	9	680	4	1.5	7
	4000	7	680	6	2.0	10
	5000	5	680	7	2.6	12
	6000	3	640	9	3.1	15
	7000	1	565	11	3.7	18
	8000	-1	485	12	4.4	21
	9000	-3	410	15	5.2	25
	10,000	-5	330	18	6.1	30
	11,000	-7	255	21	7.3	37
	12,000	-9	175	26	8.8	46

Figure 5-6. Time, Fuel, and Distance to Climb (Sheet 2 of 2)



## CRUISE PERFORMANCE

### PRESSURE ALTITUDE 2000 FEET

CONDITIONS:  
3100 Pounds  
Recommended Lean Mixture  
Cowl Flaps Closed

NOTE  
For best fuel economy, operate at the leanest mixture that results in smooth engine operation or at peak EGT if an EGT indicator is installed.

		20°C BELOW STANDARD TEMP -9°C			STANDARD TEMPERATURE 11°C			20°C ABOVE STANDARD TEMP 31°C		
RPM	MP	% BHP	KTAS	GPH	% BHP	KTAS	GPH	% BHP	KTAS	GPH
2400	23	---	---	---	76	148	13.6	73	149	13.2
	22	74	143	13.3	71	145	12.8	69	146	12.4
	21	69	140	12.4	67	141	12.0	64	142	11.6
	20	64	136	11.6	62	137	11.3	60	138	10.9
2300	23	75	145	13.5	72	146	13.1	70	147	12.6
	22	71	141	12.7	68	142	12.3	66	143	11.9
	21	66	137	11.9	64	138	11.5	62	139	11.2
	20	61	134	11.2	59	135	10.8	57	135	10.5
2200	23	72	142	12.9	69	143	12.5	67	144	12.1
	22	67	139	12.1	65	140	11.7	63	141	11.4
	21	63	135	11.4	61	136	11.0	59	137	10.7
	20	59	131	10.7	57	132	10.3	55	133	10.0
2100	23	68	139	12.2	66	140	11.8	63	141	11.5
	22	64	136	11.5	62	137	11.2	60	137	10.8
	21	60	132	10.9	58	133	10.5	56	134	10.2
	20	55	128	10.1	54	129	9.8	52	129	9.5
	19	51	124	9.4	50	124	9.1	48	125	8.9
	18	47	119	8.7	45	119	8.5	44	120	8.2

Figure 5-7. Cruise Performance (Sheet 1 of 6)

**CRUISE PERFORMANCE**  
**PRESSURE ALTITUDE 4000 FEET**

CONDITIONS:  
3100 Pounds  
Recommended Lean Mixture  
Cowl Flaps Closed

**NOTE**  
For best fuel economy, operate at the leanest mixture that results in smooth engine operation or at peak EGT if an EGT indicator is installed.

		20°C BELOW STANDARD TEMP -13°C			STANDARD TEMPERATURE 7°C			20°C ABOVE STANDARD TEMP 27°C		
RPM	MP	% BHP	KTAS	GPH	% BHP	KTAS	GPH	% BHP	KTAS	GPH
2400	23	---	---	---	78	153	14.0	75	154	13.6
	22	76	148	13.7	73	149	13.2	71	150	12.8
	21	71	144	12.8	69	145	12.4	66	146	12.0
	20	66	140	12.0	64	141	11.6	62	142	11.2
2300	23	77	149	14.0	75	150	13.5	72	151	13.0
	22	73	145	13.1	70	147	12.7	68	148	12.2
	21	68	142	12.3	66	143	11.9	64	144	11.5
	20	64	138	11.5	61	139	11.1	59	140	10.8
2200	23	74	146	13.3	71	148	12.9	69	149	12.4
	22	70	143	12.5	67	144	12.1	65	145	11.7
	21	65	139	11.8	63	140	11.4	61	141	11.0
	20	61	135	11.0	59	136	10.7	57	137	10.3
2100	23	70	143	12.7	68	145	12.2	65	146	11.8
	22	66	140	11.9	64	141	11.5	62	142	11.2
	21	62	136	11.2	60	137	10.9	58	138	10.5
	20	58	132	10.5	55	133	10.1	54	134	9.8
	19	53	128	9.8	51	129	9.5	50	129	9.2
	18	49	123	9.1	47	124	8.8	46	124	8.5

Figure 5-7. Cruise Performance (Sheet 2 of 6)

## CRUISE PERFORMANCE

### PRESSURE ALTITUDE 6000 FEET

CONDITIONS:  
3100 Pounds  
Recommended Lean Mixture  
Cowl Flaps Closed

**NOTE**  
For best fuel economy, operate at the leanest mixture that results in smooth engine operation or at peak EGT if an EGT indicator is installed.

		20°C BELOW STANDARD TEMP -17°C			STANDARD TEMPERATURE 3°C			20°C ABOVE STANDARD TEMP 23°C		
RPM	MP	% BHP	KTAS	GPH	% BHP	KTAS	GPH	% BHP	KTAS	GPH
2400	22	---	---	---	75	154	13.6	73	155	13.1
	21	73	148	13.2	71	150	12.7	68	151	12.3
	20	69	145	12.3	66	146	11.9	64	147	11.5
	19	64	140	11.5	61	141	11.1	59	142	10.8
2300	23	---	---	---	77	155	13.9	74	156	13.4
	22	75	150	13.5	72	151	13.0	70	152	12.6
	21	70	146	12.7	68	147	12.2	66	148	11.8
	20	66	142	11.9	63	143	11.5	61	144	11.1
2200	23	76	151	13.7	74	152	13.3	71	153	12.8
	22	72	147	12.9	69	148	12.5	67	150	12.1
	21	67	144	12.1	65	145	11.7	63	146	11.4
	20	63	140	11.4	61	141	11.0	59	141	10.7
2100	23	72	148	13.1	70	149	12.6	68	150	12.2
	22	68	144	12.3	66	145	11.9	64	146	11.5
	21	64	141	11.6	62	142	11.2	60	142	10.8
	20	60	137	10.9	57	137	10.5	56	138	10.2
	19	55	132	10.1	53	133	9.8	52	133	9.5
	18	51	128	9.4	49	128	9.1	48	128	8.8

Figure 5-7. Cruise Performance (Sheet 3 of 6)

## CRUISE PERFORMANCE

### PRESSURE ALTITUDE 8000 FEET

CONDITIONS:  
3100 Pounds  
Recommended Lean Mixture  
Cowl Flaps Closed

**NOTE**  
For best fuel economy, operate at the leanest mixture that results in smooth engine operation or at peak EGT if an EGT indicator is installed.

		20°C BELOW STANDARD TEMP -21°C			STANDARD TEMPERATURE -1°C			20°C ABOVE STANDARD TEMP 19°C		
RPM	MP	% BHP	KTAS	GPH	% BHP	KTAS	GPH	% BHP	KTAS	GPH
2400	21	76	153	13.6	73	154	13.1	70	155	12.7
	20	71	149	12.7	68	150	12.3	66	151	11.9
	19	66	145	11.9	63	146	11.5	61	147	11.1
	18	61	140	11.1	59	141	10.7	57	142	10.3
2300	21	73	151	13.1	70	152	12.6	68	153	12.2
	20	68	147	12.2	65	148	11.8	63	149	11.4
	19	63	142	11.4	61	143	11.1	59	144	10.7
	18	58	138	10.6	56	138	10.3	54	139	9.9
2200	21	70	148	12.5	67	149	12.1	65	150	11.7
	20	65	144	11.7	63	145	11.3	60	146	11.0
	19	60	140	11.0	58	141	10.6	56	141	10.3
	18	56	135	10.2	54	136	9.9	52	136	9.5
2100	21	66	145	11.9	64	146	11.5	61	147	11.2
	20	62	141	11.2	59	142	10.8	57	142	10.5
	19	57	137	10.5	55	137	10.1	53	138	9.8
	18	53	132	9.7	51	132	9.4	49	133	9.1
	17	49	127	9.0	47	127	8.7	45	127	8.4

Figure 5-7. Cruise Performance (Sheet 4 of 6)

## CRUISE PERFORMANCE

### PRESSURE ALTITUDE 10,000 FEET

CONDITIONS:  
3100 Pounds  
Recommended Lean Mixture  
Cowl Flaps Closed

NOTE  
For best fuel economy, operate at the leanest mixture that results in smooth engine operation or at peak EGT if an EGT indicator is installed.

		20°C BELOW STANDARD TEMP -25°C			STANDARD TEMPERATURE -5°C			20°C ABOVE STANDARD TEMP 15°C		
RPM	MP	% BHP	KTAS	GPH	% BHP	KTAS	GPH	% BHP	KTAS	GPH
2400	20	73	154	13.1	70	155	12.6	68	156	12.2
	19	68	149	12.2	65	150	11.8	63	151	11.4
	18	63	145	11.4	60	145	11.0	58	146	10.6
	17	58	140	10.6	56	140	10.2	54	141	9.9
2300	20	70	151	12.6	67	152	12.2	65	153	11.8
	19	65	147	11.8	63	148	11.4	61	149	11.0
	18	60	142	11.0	58	143	10.6	56	143	10.3
	17	56	137	10.2	53	138	9.8	52	138	9.5
2200	20	67	149	12.1	65	150	11.7	62	150	11.3
	19	62	144	11.3	60	145	10.9	58	146	10.6
	18	58	140	10.5	56	140	10.2	54	140	9.9
	17	53	134	9.8	51	135	9.4	49	135	9.1
2100	20	64	146	11.5	61	146	11.2	59	147	10.8
	19	59	141	10.8	57	142	10.4	55	142	10.1
	18	55	136	10.1	53	137	9.7	51	137	9.4
	17	51	131	9.3	49	131	9.0	47	131	8.7
	16	46	125	8.6	44	125	8.3	43	125	8.1

Figure 5-7. Cruise Performance (Sheet 5 of 6)

## CRUISE PERFORMANCE

### PRESSURE ALTITUDE 12,000 FEET

CONDITIONS:  
3100 Pounds  
Recommended Lean Mixture  
Cowl Flaps Closed

**NOTE**

For best fuel economy, operate at the leanest mixture that results in smooth engine operation or at peak EGT if an EGT indicator is installed.

		20°C BELOW STANDARD TEMP -29°C			STANDARD TEMPERATURE -9°C			20°C ABOVE STANDARD TEMP 11°C		
RPM	MP	% BHP	KTAS	GPH	% BHP	KTAS	GPH	% BHP	KTAS	GPH
2400	18	65	149	11.7	62	150	11.3	60	151	10.9
	17	60	144	10.9	57	145	10.5	55	145	10.1
	16	55	138	10.0	53	139	9.7	51	139	9.4
	15	50	132	9.2	48	132	8.8	46	132	8.6
2300	18	62	147	11.3	60	148	10.9	58	148	10.6
	17	57	142	10.5	55	142	10.1	53	142	9.8
	16	53	136	9.7	51	136	9.3	49	136	9.0
	15	48	130	8.8	46	130	8.5	44	129	8.3
2200	18	60	144	10.9	58	145	10.5	56	145	10.2
	17	55	139	10.1	53	139	9.7	51	139	9.4
	16	50	133	9.3	48	133	9.0	47	133	8.7
2100	18	57	141	10.4	55	141	10.0	53	142	9.7
	17	52	136	9.6	50	136	9.3	49	136	9.0
	16	48	130	8.9	46	130	8.6	44	129	8.3

Figure 5-7. Cruise Performance (Sheet 6 of 6)

## RANGE PROFILE

45 MINUTES RESERVE  
56 GALLONS USABLE FUEL

CONDITIONS:  
3100 Pounds  
Recommended Lean Mixture for Cruise  
Standard Temperature  
Zero Wind

NOTES:

1. This chart allows for the fuel used for engine start, taxi, takeoff and climb, and the distance during a normal climb as shown in figure 5-6.
2. Reserve fuel is based on 45 minutes at 45% BHP and is 6.3 gallons.

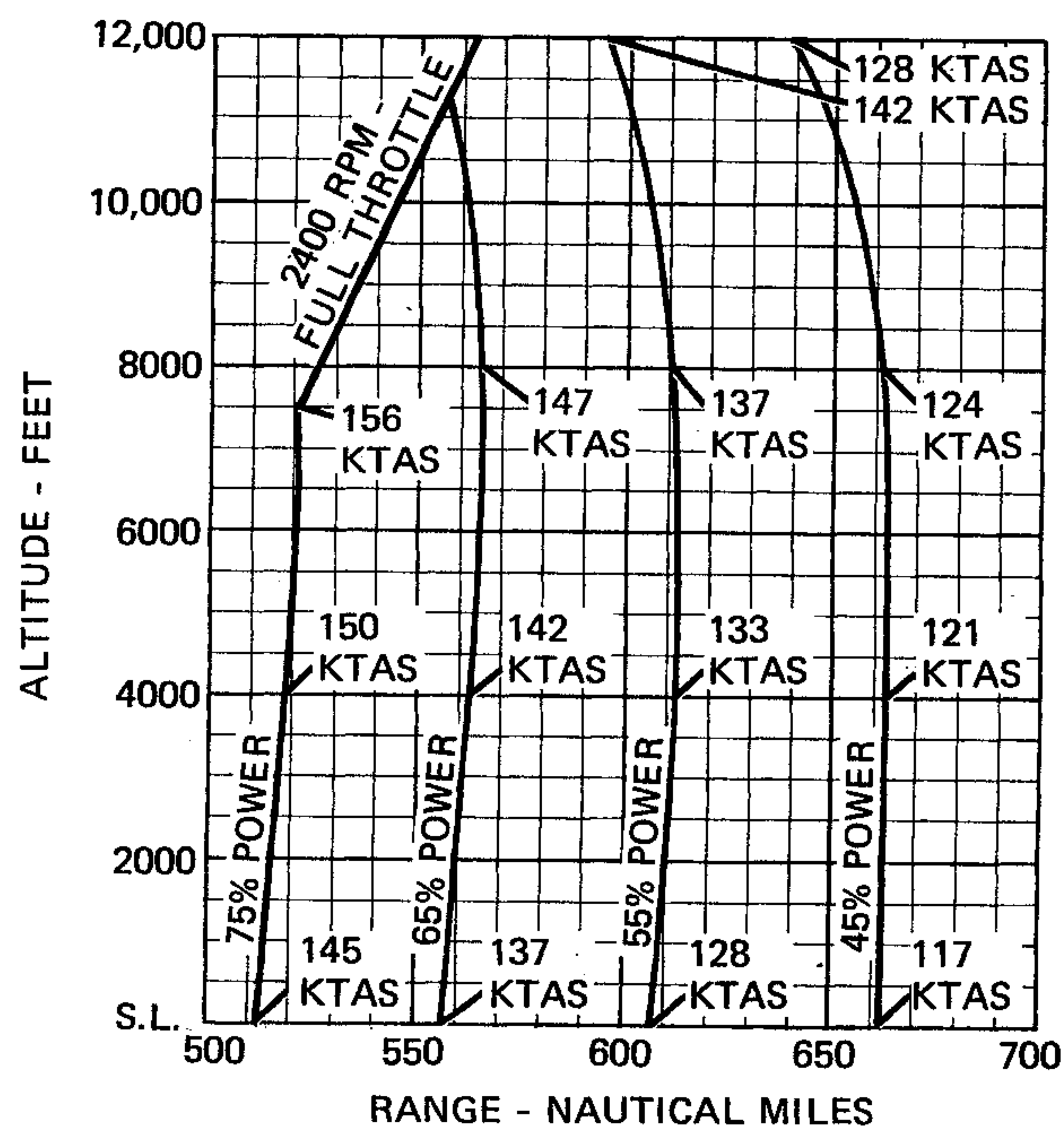

Figure 5-8. Range Profile (Sheet 1 of 2)

**RANGE PROFILE**  
**45 MINUTES RESERVE**  
**75 GALLONS USABLE FUEL**

**CONDITIONS:**  
3100 Pounds  
Recommended Lean Mixture for Cruise  
Standard Temperature  
Zero Wind

- NOTES:**
1. This chart allows for the fuel used for engine start, taxi, takeoff and climb, and the distance during a normal climb as shown in figure 5-6.
  2. Reserve fuel is based on 45 minutes at 45% BHP and is 6.3 gallons.

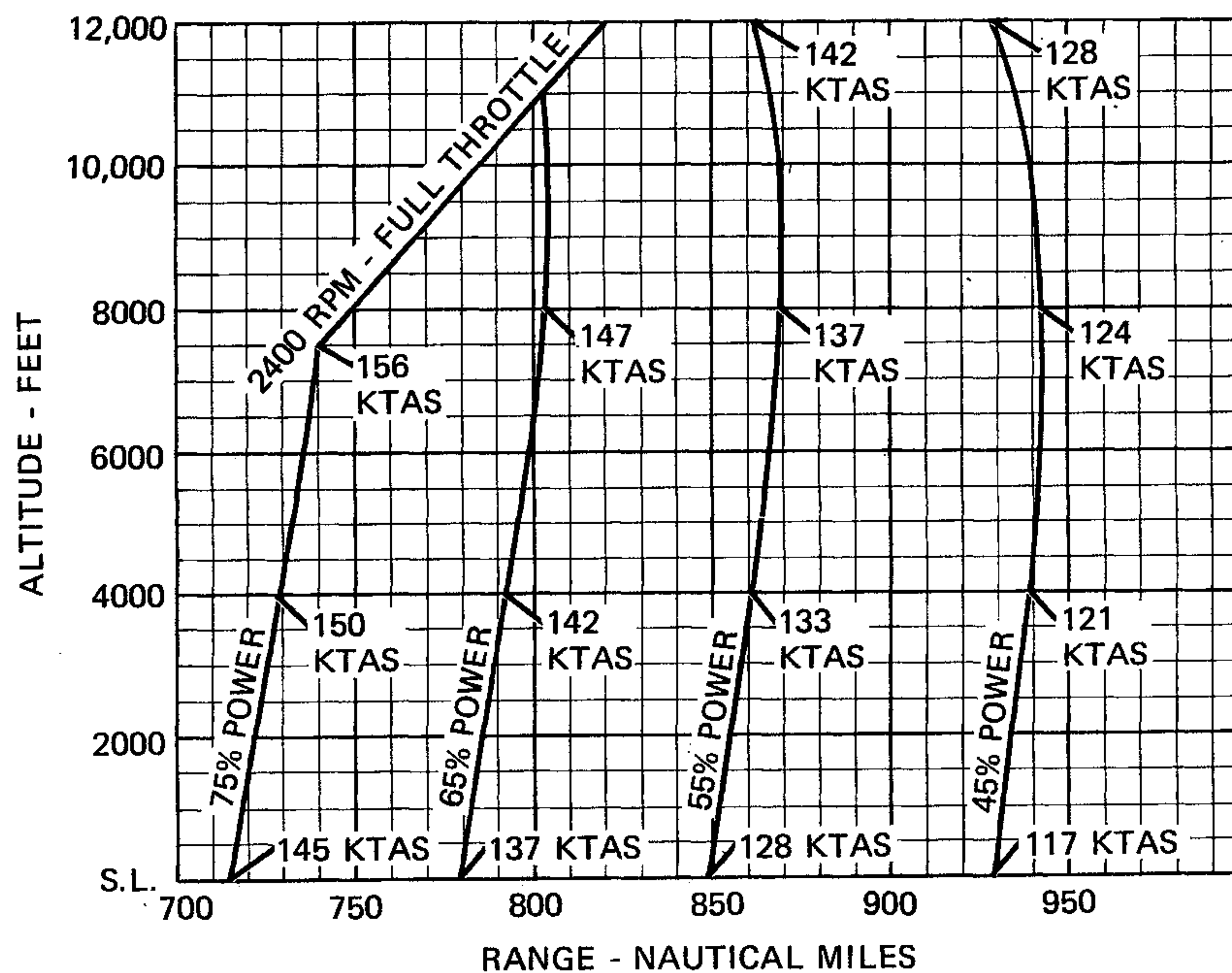

Figure 5-8. Range Profile (Sheet 2 of 2)



## ENDURANCE PROFILE

45 MINUTES RESERVE  
56 GALLONS USABLE FUEL

CONDITIONS:  
3100 pounds  
Recommended Lean Mixture for Cruise  
Standard Temperature

NOTES:

1. This chart allows for the fuel used for engine start, taxi, takeoff and climb, and the time during a normal climb as shown in figure 5-6.
2. Reserve fuel is based on 45 minutes at 45% BHP and is 6.3 gallons.

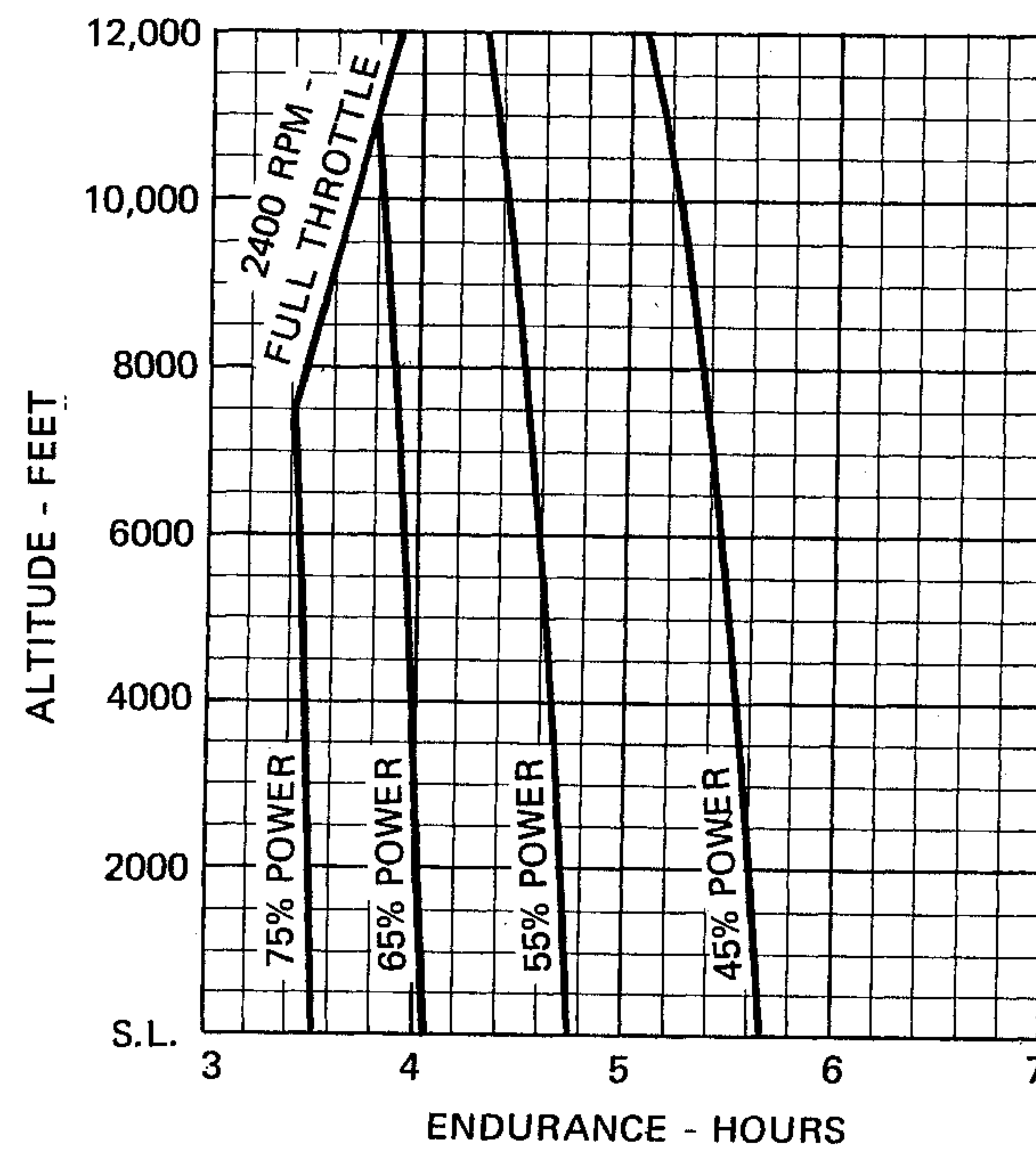

Figure 5-9. Endurance Profile (Sheet 1 of 2)

## ENDURANCE PROFILE

45 MINUTES RESERVE  
75 GALLONS USABLE FUEL

CONDITIONS:  
3100 Pounds  
Recommended Lean Mixture for Cruise  
Standard Temperature

NOTES:

1. This chart allows for the fuel used for engine start, taxi, takeoff and climb, and the time during a normal climb as shown in figure 5-6.
2. Reserve fuel is based on 45 minutes at 45% BHP and is 6.3 gallons.

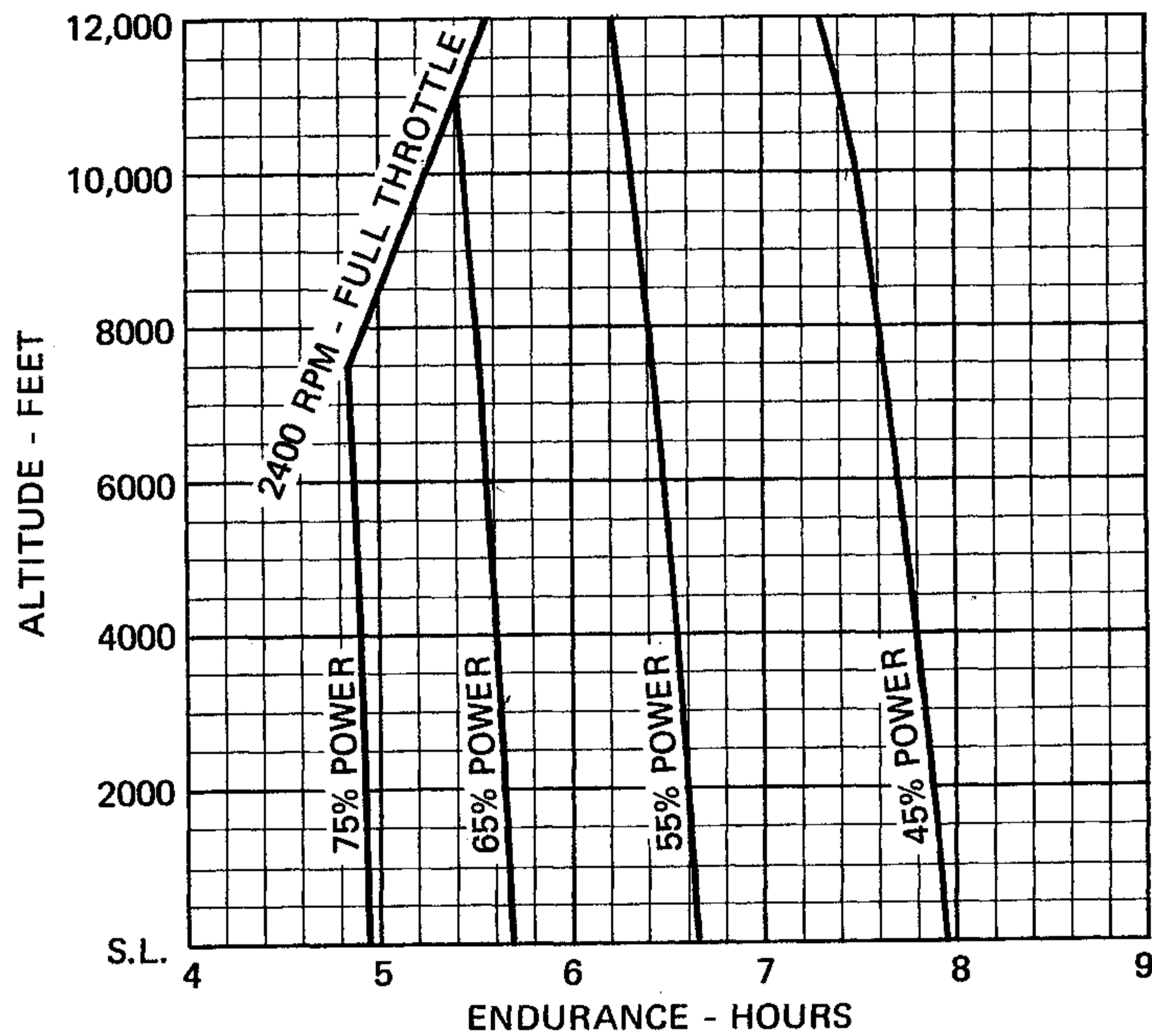

Figure 5-9. Endurance Profile (Sheet 2 of 2)

## LANDING DISTANCE

### SHORT FIELD

**CONDITIONS:**

Flaps 40°  
Power Off  
Maximum Braking  
Paved, Level, Dry Runway  
Zero Wind

**NOTES:**

1. Short field technique as specified in Section 4.
2. Decrease distances 10% for each 9 knots headwind. For operation with tailwinds up to 10 knots, increase distances by 10% for each 2 knots.
3. For operation on a dry, grass runway, increase distances by 40% of the "ground roll" figure.

WEIGHT LBS	SPEED AT 50 FT KIAS	PRESS ALT FT	0°C		10°C		20°C		30°C		40°C	
			GRND ROLL	TOTAL TO CLEAR 50 FT OBS	GRND ROLL	TOTAL TO CLEAR 50 FT OBS	GRND ROLL	TOTAL TO CLEAR 50 FT OBS	GRND ROLL	TOTAL TO CLEAR 50 FT OBS	GRND ROLL	TOTAL TO CLEAR 50 FT OBS
3100	63	S.L.	570	1270	590	1305	610	1335	630	1370	650	1400
		1000	590	1305	610	1335	635	1375	655	1410	675	1440
		2000	610	1335	635	1375	655	1410	680	1450	700	1480
		3000	635	1375	660	1415	680	1450	705	1490	730	1530
		4000	660	1415	685	1455	705	1490	730	1530	755	1570
		5000	685	1455	710	1495	735	1535	760	1580	785	1620
		6000	710	1500	735	1540	760	1580	790	1625	815	1665
		7000	735	1540	765	1585	790	1630	820	1675	845	1715
8000	765	1585	795	1635	820	1675	850	1725	880	1770		

Figure 5-10. Landing Distance



# SECTION 6 WEIGHT & BALANCE/ EQUIPMENT LIST

## TABLE OF CONTENTS

	Page
Introduction . . . . .	6-3
Airplane Weighing Procedures . . . . .	6-3
Weight And Balance . . . . .	6-6
Baggage Tie-Down . . . . .	6-6
Equipment List . . . . .	6-15



## INTRODUCTION

This section describes the procedure for establishing the basic empty weight and moment of the airplane. Sample forms are provided for reference. Procedures for calculating the weight and moment for various operations are also provided. A comprehensive list of all Cessna equipment available for this airplane is included at the back of this section.

It should be noted that specific information regarding the weight, arm, moment and installed equipment list for this airplane can only be found in the appropriate weight and balance records carried in the airplane.

## AIRPLANE WEIGHING PROCEDURES

1. Preparation:
  - a. Inflate tires to recommended operating pressures.
  - b. Remove the fuel tank sump quick-drain fittings and fuel selector valve drain plug to drain all fuel.
  - c. Remove oil sump drain plug to drain all oil.
  - d. Move sliding seats to the most forward position.
  - e. Raise flaps to the fully retracted position.
  - f. Place all control surfaces in neutral position.
2. Leveling:
  - a. Place scales under each wheel (minimum scale capacity, 1000 pounds).
  - b. Deflate the nose tire and/or lower or raise the nose strut to properly center the bubble in the level (see figure 6-1).
3. Weighing:
  - a. With the airplane level and brakes released, record the weight shown on each scale. Deduct the tare, if any, from each reading.
4. Measuring:
  - a. Obtain measurement A by measuring horizontally (along the airplane center line) from a line stretched between the main wheel centers to a plumb bob dropped from the firewall.
  - b. Obtain measurement B by measuring horizontally and parallel to the airplane center line, from center of nose wheel axle, left side, to a plumb bob dropped from the line between the main wheel centers. Repeat on right side and average the measurements.
5. Using weights from item 3 and measurements from item 4, the airplane weight and C.G. can be determined.
6. Basic Empty Weight may be determined by completing figure 6-1.

**SECTION 6  
WEIGHT & BALANCE/  
EQUIPMENT LIST**

**CESSNA  
MODEL R182**

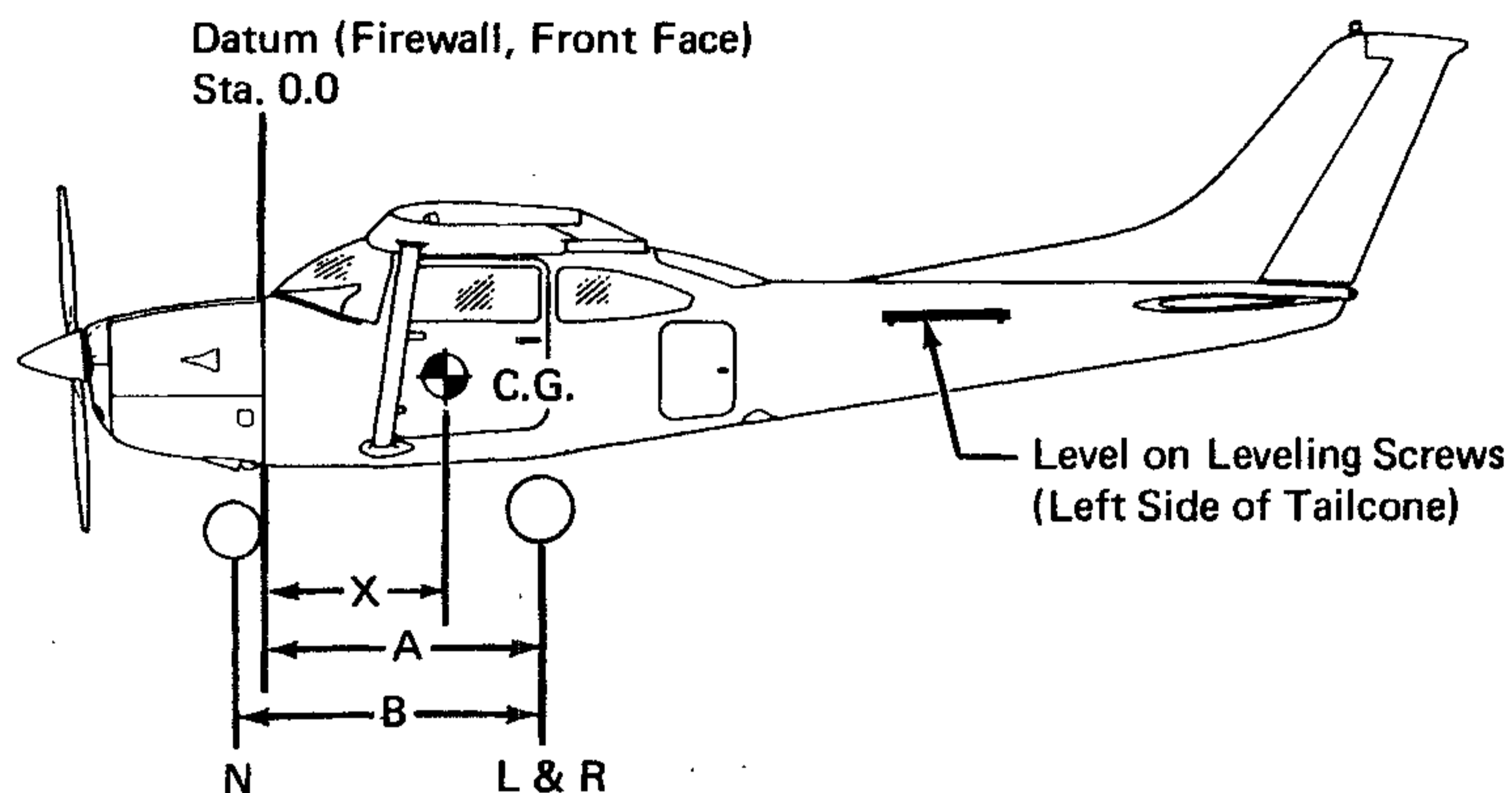
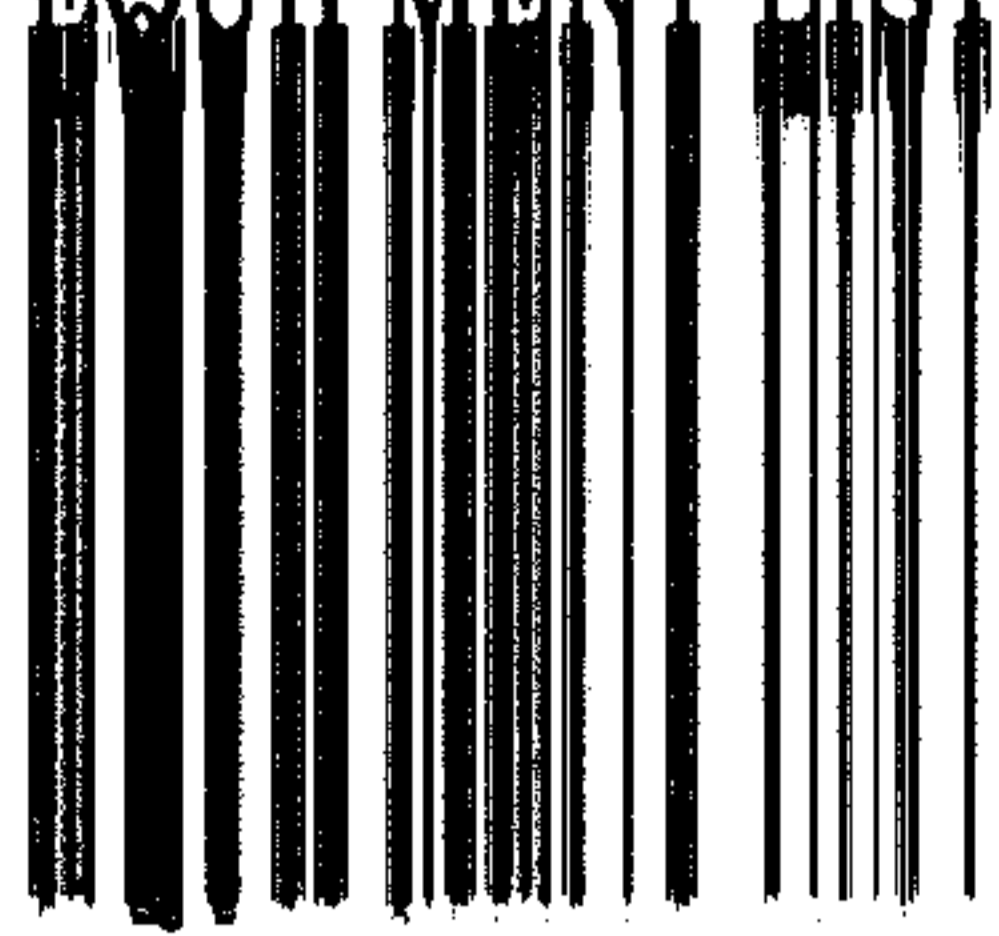

Scale Position	Scale Reading	Tare	Symbol	Net Weight
Left Wheel			L	
Right Wheel			R	
Nose Wheel			N	
Sum of Net Weights (As Weighed)			W	

$$X = \text{ARM} = \frac{(A) - (N) \times (B)}{W}; X = ( \quad ) - \frac{( \quad ) \times ( \quad )}{( \quad )} = ( \quad ) \text{ IN.}$$

Item	Weight (Lbs.)	C.G. Arm (In.)	Moment/1000 (Lbs.-In.)
Airplane Weight (From Item 5, page 6-3)			
Add Oil: (9 Qts at 7.5 Lbs/Gal)		-15.7	
Add Unusable Fuel: (Std. Tanks (5 Gal at 6 Lbs/Gal) L.R. Tanks (5 Gal at 6 Lbs/Gal)		46.0	
Equipment Changes			
Airplane Basic Empty Weight			

**Figure 6-1. Sample Airplane Weighing**



### SAMPLE WEIGHT AND BALANCE RECORD

(Continuous History of Changes in Structure or Equipment Affecting Weight and Balance)

AIRPLANE MODEL				SERIAL NUMBER				PAGE NUMBER				
DATE	ITEM NO.		DESCRIPTION OF ARTICLE OR MODIFICATION	WEIGHT CHANGE				RUNNING BASIC EMPTY WEIGHT				
	In	Out		ADDED (+)		REMOVED (-)		Wt. (lb.)	Moment /1000	Wt. (lb.)	Moment /1000	

Figure 6-2. Sample Weight and Balance Record

## WEIGHT AND BALANCE

The following information will enable you to operate your Cessna within the prescribed weight and center of gravity limitations. To figure weight and balance, use the Sample Problem, Loading Graph, and Center of Gravity Moment Envelope as follows:

Take the basic empty weight and moment from appropriate weight and balance records carried in your airplane, and enter them in the column titled YOUR AIRPLANE on the Sample Loading Problem.

### NOTE

In addition to the basic empty weight and moment noted on these records, the C.G. arm (fuselage station) is also shown, but need not be used on the Sample Loading Problem. The moment which is shown must be divided by 1000 and this value used as the moment/1000 on the loading problem.

Use the Loading Graph to determine the moment/1000 for each additional item to be carried; then list these on the loading problem.

### NOTE

Loading Graph information for the pilot, passengers and baggage is based on seats positioned for average occupants and baggage items loaded in the center of these areas as shown on the Loading Arrangements diagram. For loadings which may differ from these, the Sample Loading Problem lists fuselage stations for these items to indicate their forward and aft C.G. range limitation (seat travel and baggage area limitation). Additional moment calculations, based on the actual weight and C.G. arm (fuselage station) of the item being loaded, must be made if the position of the load is different from that shown on the Loading Graph.

Total the weights and moments/1000 and plot these values on the Center of Gravity Moment Envelope to determine whether the point falls within the envelope, and if the loading is acceptable.

## BAGGAGE TIE-DOWN

A nylon baggage net having six tie-down straps is provided as standard equipment to secure baggage in the area aft of the rear seat (Baggage A) and over the wheel well (Baggage B). Eight eyebolts serve as

attaching points for the net. Two eyebolts for the forward tie-down straps are mounted on the cabin floor near each sidewall just forward of the baggage door approximately at station 92; two eyebolts are installed on the cabin floor slightly inboard of each sidewall just forward of the wheel well approximately at station 109; and two eyebolts are mounted on the upper forward surface of the wheel well slightly inboard of each sidewall approximately at station 109. The two aft eyebolts are installed above the aft portion of the wheel well and slightly inboard of each sidewall approximately at station 124.

When the cabin floor (Baggage A) only is utilized for baggage, the four eyebolts located on the cabin floor may be used, or the two forward eyebolts on the cabin floor and the two eyebolts on the upper forward surface of the wheel well may be used. When the upper surface of the wheel well (Baggage B) only contains baggage, the two eyebolts on the upper forward surface of the wheel well and the two aft eyebolts above the aft portion of the wheel well should be used. When there is baggage in both areas, the two forward eyebolts on the cabin floor, the two eyebolts on the upper forward surface of the wheel well, and the two aft eyebolts above the aft portion of the wheel well should be utilized.

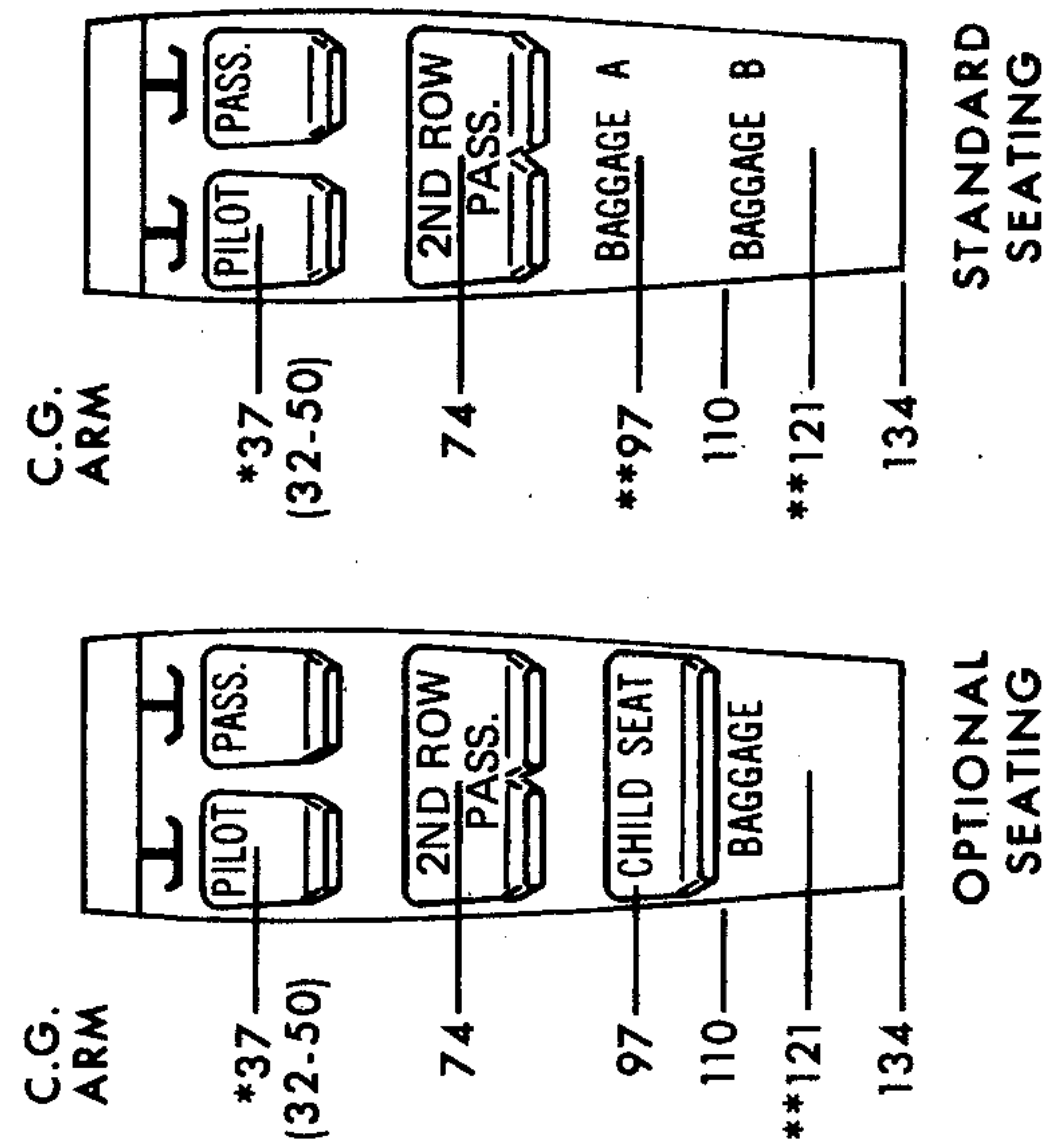

## LOADING ARRANGEMENTS

\* Pilot or passenger center of gravity on adjustable seats positioned for average occupant. Numbers in parenthesis indicate forward and aft limits of occupant center of gravity range.

\*\* Baggage area center of gravity.

NOTE: The aft baggage wall (approximate station 134) can be used as a convenient interior reference point for determining the location of baggage area fuselage stations.

Figure 6-3. Loading Arrangements

CABIN HEIGHT MEASUREMENTS

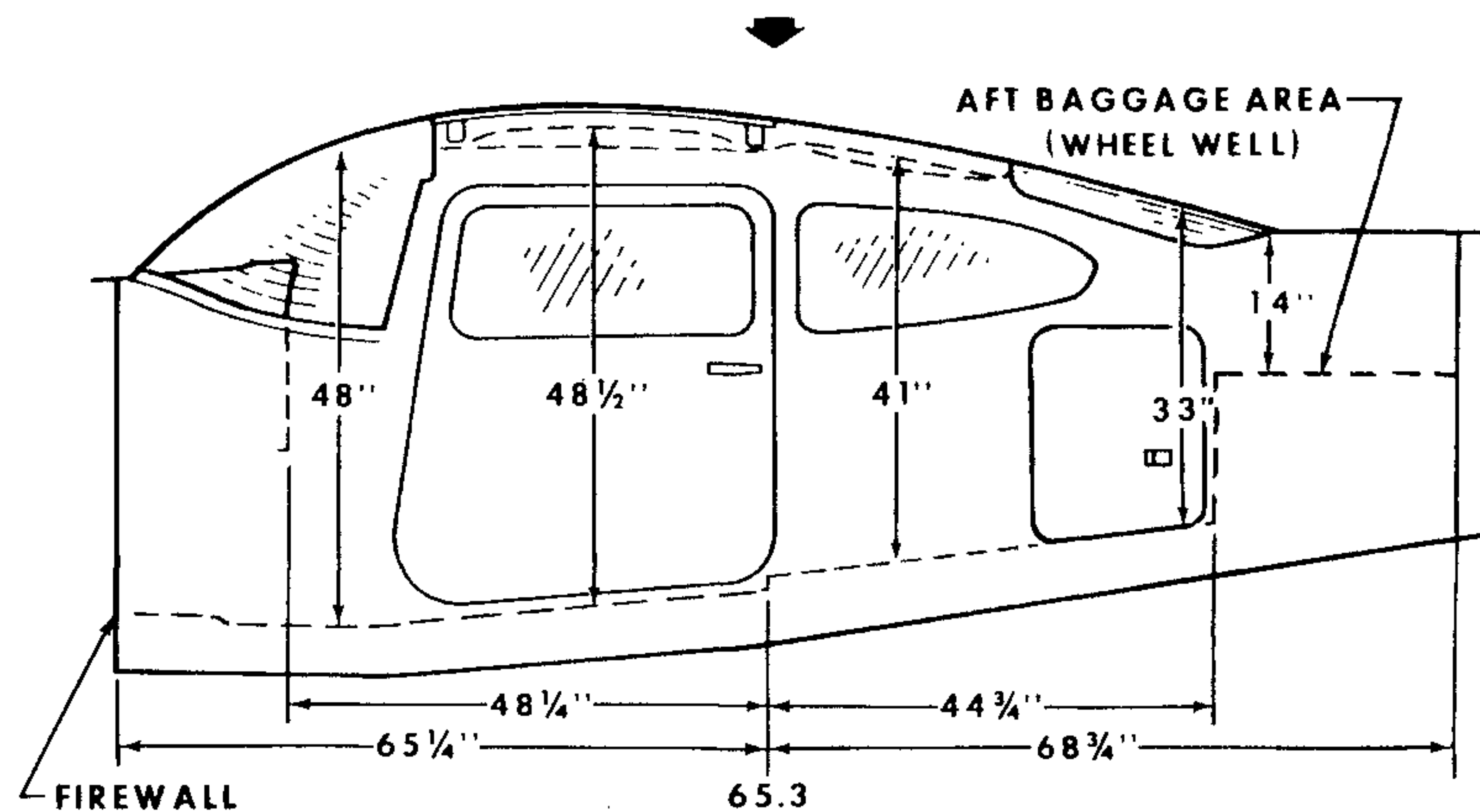

DOOR OPENING DIMENSIONS

	WIDTH (TOP)	WIDTH (BOTTOM)	HEIGHT (FRONT)	HEIGHT (REAR)	
CABIN DOOR	32"	36 1/2"	41"	38 1/2"	— WIDTH —
BAGGAGE DOOR	15 3/4"	15 3/4"	22"	20 1/2"	● LWR WINDOW LINE
					* CABIN FLOOR

CABIN WIDTH MEASUREMENTS

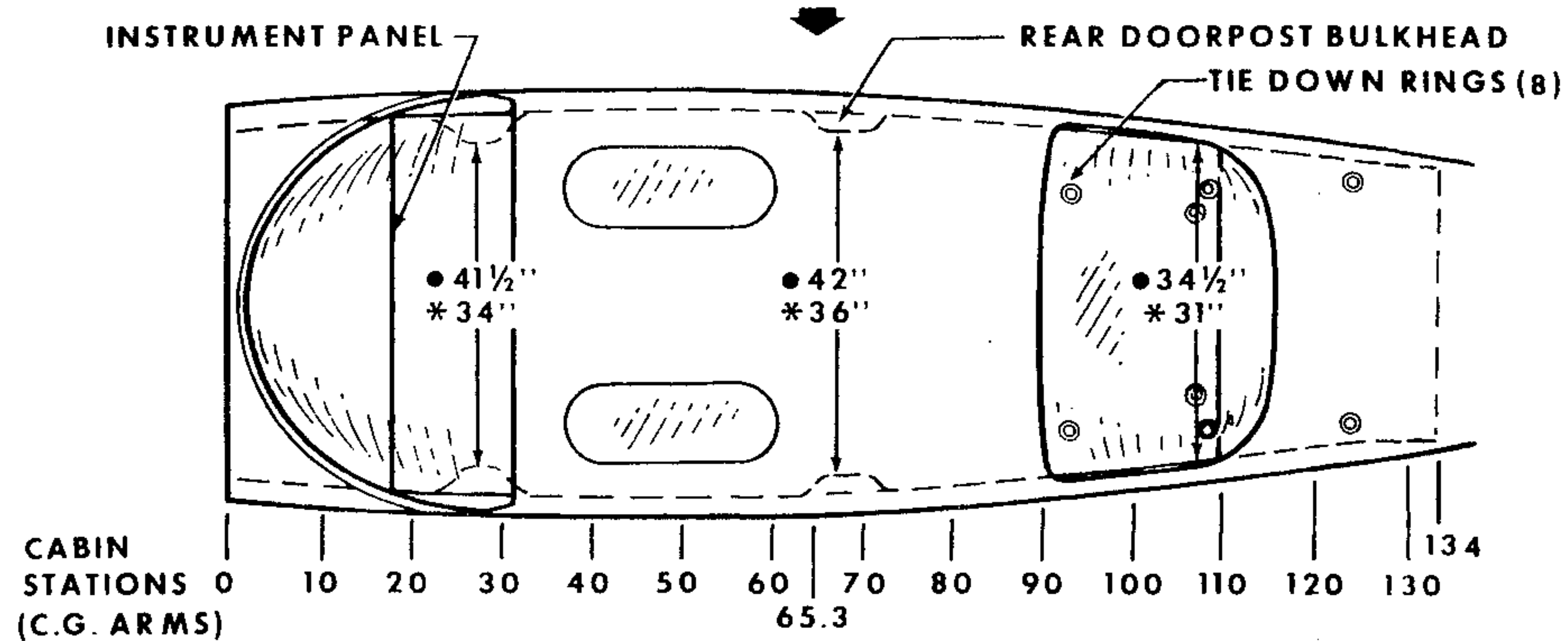

Figure 6-4. Internal Cabin Dimensions

SECTION 6  
WEIGHT & BALANCE/  
EQUIPMENT LIST

CESSNA  
MODEL R182

SAMPLE AIRPLANE	YOUR AIRPLANE			
	Weight (lbs.)	Moment (lb.-ins./1000)		
<p><b>SAMPLE LOADING PROBLEM</b></p> <p>1. Basic Empty Weight (Use the data pertaining to your airplane as it is presently equipped. Includes unusable fuel and full oil) . . . . .</p> <p>2. Usable Fuel (At 6 Lbs./Gal.) Standard Tanks (56 Gal. Maximum) . . . . . Long Range Tanks (75 Gal. Maximum) . . . . .</p> <p>3. Pilot and Front Passenger (Sta. 32 to 50) . . . . .</p> <p>4. Second Row Passengers . . . . .</p> <p>5. Baggage (Area "A") or Passenger on Child's Seat (Station 82 to 110) 120 Lbs. Maximum . . . . .</p> <p>6. Baggage - Aft (Area "B") (Station 110 to 134) 80 Lbs. Maximum . . . . .</p> <p>7. RAMP WEIGHT AND MOMENT</p> <p>8. Fuel allowance for engine start, taxi and runup . . . . .</p> <p>9. TAKEOFF WEIGHT AND MOMENT (Subtract step 8 from step 7)</p> <p>10. Locate this point (3100 at 138.9) on the Center of Gravity Moment Envelope, and since this point falls within the envelope, the loading is acceptable.</p>	1808	62.0	1980	68.8
	450	21.6	450	20.7
	340	12.6	500	18.5
	340	25.2	400	29.6
	120	11.6	100	9.7
	54	6.5		
	3112	139.5	3430	147.3
	-12	-.6		
	3100	138.9		

Figure 6-5. Sample Loading Problem

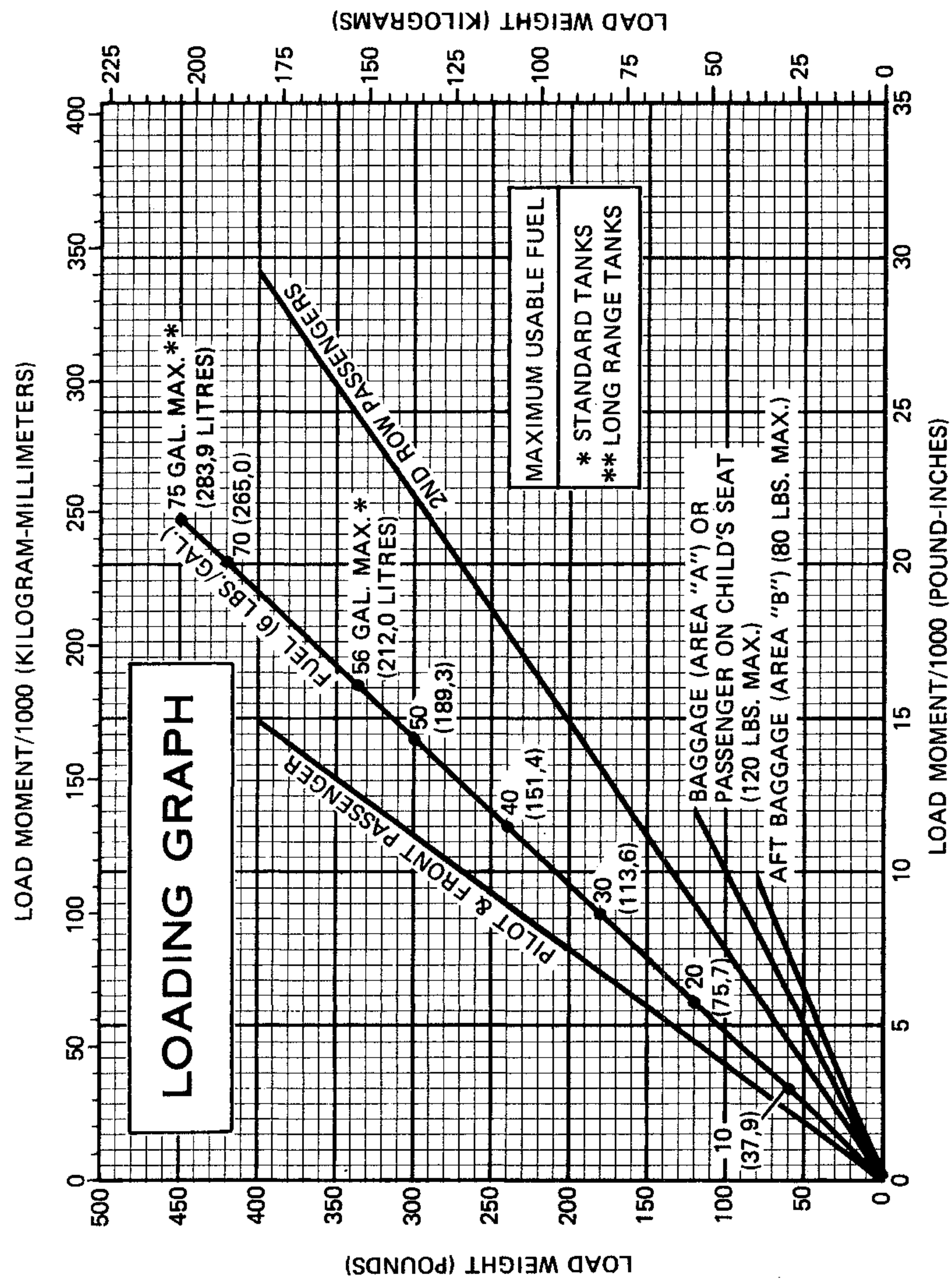

NOTE: Line representing adjustable seats shows the pilot and front seat passenger center of gravity on adjustable seats positioned for an average occupant. Refer to the Loading Arrangements diagram for forward and aft limits of occupant C.G. range.

Figure 6-6. Loading Graph

SECTION 6  
WEIGHT & BALANCE/

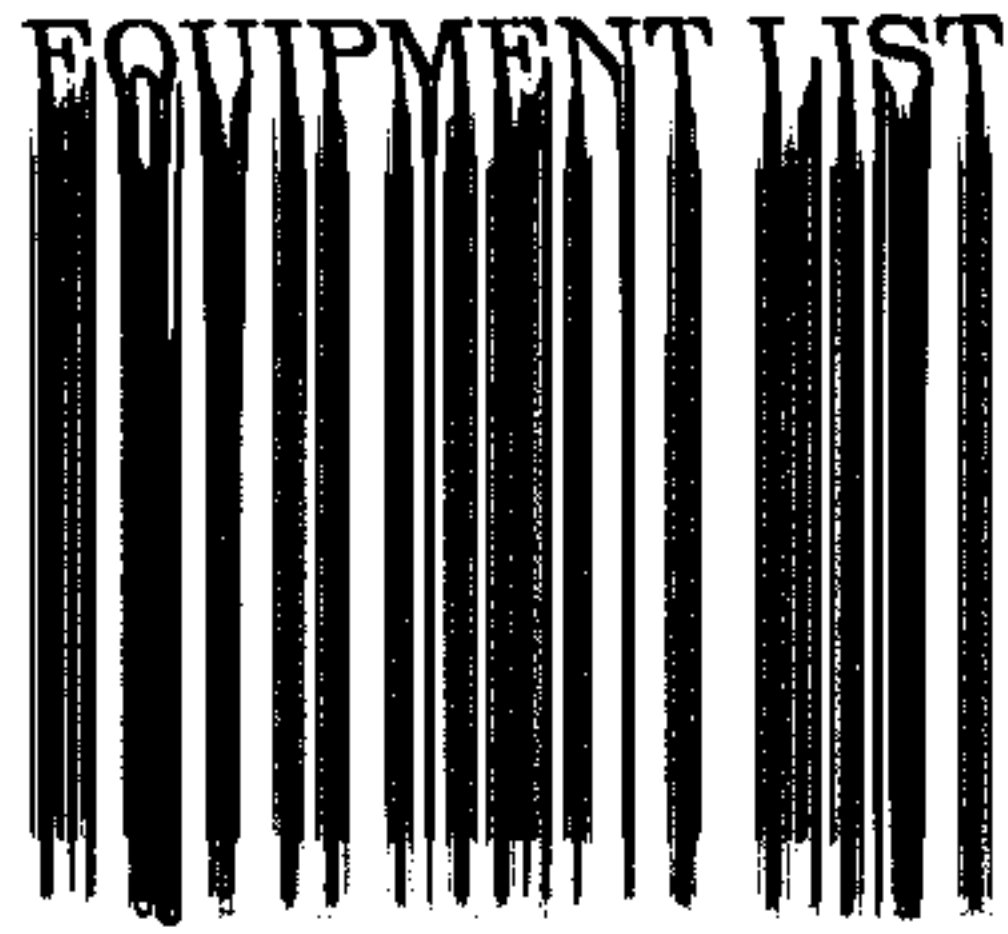

CESSNA  
MODEL R182

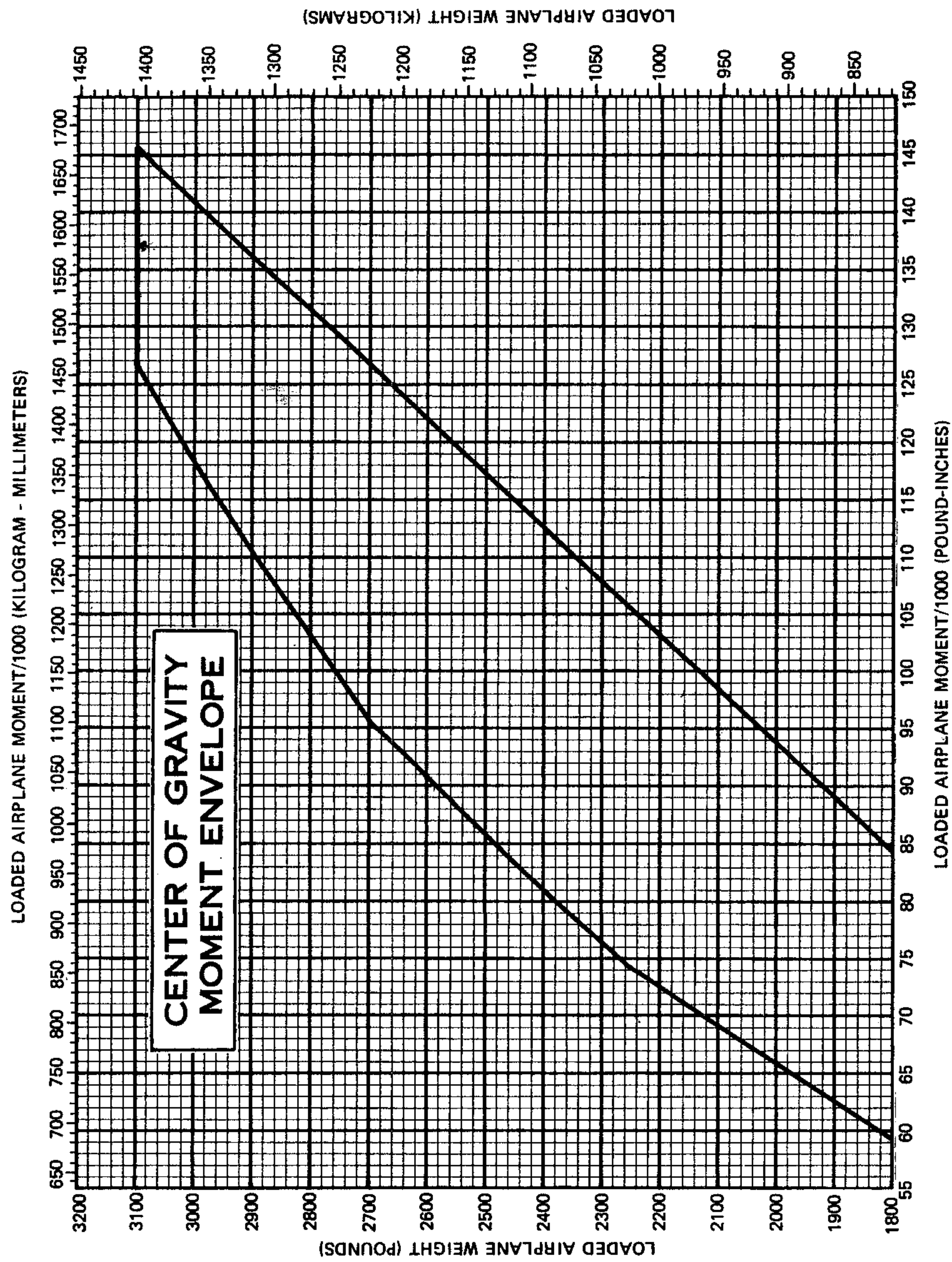

Figure 6-7. Center of Gravity Moment Envelope



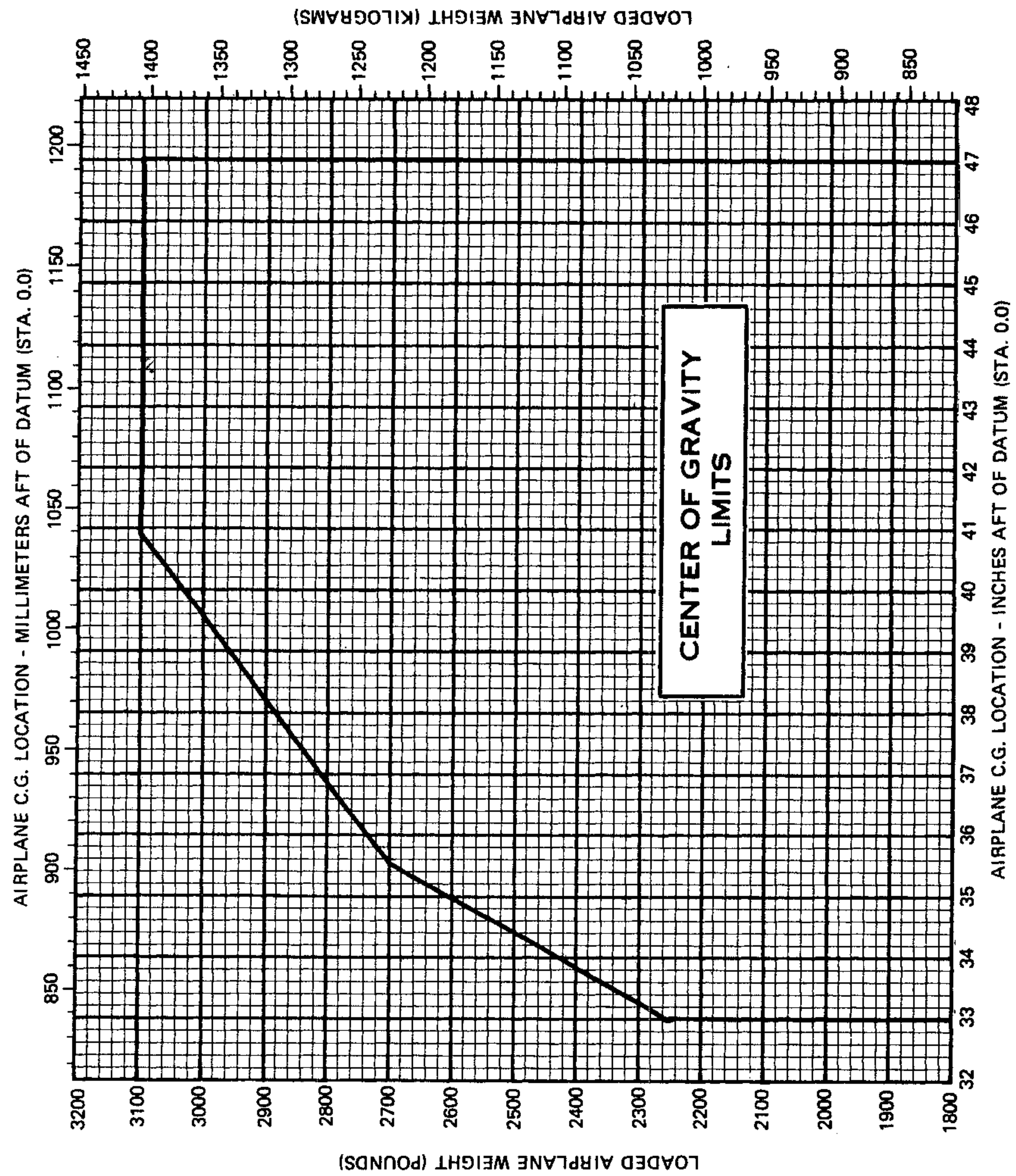

Figure 6-8. Center of Gravity Limits



## EQUIPMENT LIST

The following equipment list is a comprehensive list of all Cessna equipment available for this airplane. A separate equipment list of items installed in your specific airplane is provided in your aircraft file. The following list and the specific list for your airplane have a similar order of listing.

This equipment list provides the following information:

An **item number** gives the identification number for the item. Each number is prefixed with a letter which identifies the **descriptive** grouping (example: A. Powerplant & Accessories) under which it is listed. Suffix letters identify the equipment as a required item, a standard item or an optional item. Suffix letters are as follows:

- R = required items of equipment for FAA certification
- S = standard equipment items
- O = optional equipment items replacing required or standard items
- A = optional equipment items which are in addition to required or standard items

A **reference drawing** column provides the drawing number for the item.

### NOTE

If additional equipment is to be installed, it must be done in accordance with the reference drawing, accessory kit instructions, or a separate FAA approval.

Columns showing **weight (in pounds)** and **arm (in inches)** provide the weight and center of gravity location for the equipment.

### NOTE

Unless otherwise indicated, true values (not net change values) for the weight and arm are shown. Positive arms are distances aft of the airplane datum; negative arms are distances forward of the datum.

### NOTE

Asterisks (\*) after the item weight and arm indicate complete assembly installations. Some major components of the assembly are listed on the lines immediately following. The summation of these major components does not necessarily equal the complete assembly installation.

SECTION 6  
WEIGHT & BALANCE/  
EQUIPMENT LIST

CESSNA  
MODEL R182

ITEM NO	EQUIPMENT LIST DESCRIPTION	REF DRAWING	WT LBS	ARM INS
A01-R	A. POWERPLANT & ACCESSORIES ENGINE LYCOMING O-540-J3C5D ENPL 2524 BENDIX MAGNETO (IMPULSE COUPLING) CARBURETOR MARVEL SCHEBLER STARTER PRESTOLITE 24 VOLT SPARK PLUGS SHIELDED FUEL PUMP DYNAFOCAL MOUNTING BRACKETS (2) UPR (2) LWR	2250000 D6LN-2031 TYPE HA-6  C294510-0901 C611503-0102 10610A C294506-0102 C161008-0107 C161031-0109 2250003 1750050-1 1752637-16 1750051-1 1706003-2 C431003-0102 C668540-0101 2206001	389.0* 11.5 18.0 12.67 1.0 20.8 10.73 13.1 53.0 33.4* 33.1* 2.1 1.45* 20.3 0.7 0.2	-23.0* -6.5 -33.0 -6.5 -12.3 -4.6 -34.6 -35.0 -41.6 -36.0* -44.2 -46.5 -37.0* -3.3 16.7 -19.0
A05-R A09-R A17-S A22-S A33-R A37-R A41-R	FILTER, CARBURETOR AIR ALTERNATOR, 28 VOLT, 60 AMP OIL COOLER OIL FILTER PROPELLER MCCAULEY (B2D34C214/900HB-8) GOVERNOR, PROPELLER (MCCAULEY D290-D3/T16) SPINNER, INSTALLATION, PROPELLER SPINNER ASY. DOME ASY. BULKHEAD ASY. VACUUM SYSTEM, ENGINE DRIVEN VACUUM PUMP VACUUM PUMP SUCTION GAGE PRIMING SYS. 4-CYL. OIL QUICK DRAIN VALVE			
A61-S				
A70-S A73-A				
B01-R	B. LANDING GEAR & ACCESSORIES WHEEL & TIRE ASSY, BRAKE ASSY MAIN (EACH) WHEEL & TIRE ASSY WHEEL ASY. MCCAULEY TIRE 6.00X6 6-PLY TUBE BRAKE ASSY. -RH -LH	C163016B-0129 C613004-0102 C262006-0101 C262026-0101 C163032-0206 C163032-0205 1241156-104 1241156-12 C262023-0101	17.7* 14.6* 17.2 16.2 13.1 39.3* 25.8 25.0 1.2	57.5* 58.0*       55.0 57.2* -7.2 -7.2
B04-R-1	WHEEL & TIRE ASSY, 5.00X5 NOSE WHEEL ASSY CLEVELAND 40-77 TIRE, 6-PLY RATED BLACKWALL TUBE			

ITEM NO	EQUIPMENT LIST DESCRIPTION	REF DRAWING	WT LBS	ARM INS
B04-R-2	WHEEL & TIRE ASY 5.00X5 NOSE GEAR WHEEL (MCCAULEY-ALUMINUM) TIRE 6-PLY RATED BLACKWALL	C16301880103	10.0	-7.2*
B04-R-3	WHEEL & TIRE ASY 5.00X5 NOSE GEAR WHEEL (MCCAULEY-ALUMINUM) TIRE 6-PLY RATED BLACKWALL	C16301880108	3.6 5.3 1.1	-7.2 -7.2 -7.2
B16-R	AXLE, STANDARD DUTY MAIN GEAR (SET CF 2)	0541124-1	3.6 5.3 1.1 1.9	-7.2 -7.2 -7.2 58.0
	C. ELECTRICAL SYSTEMS			
C01-R-1	BATTERY 24 VOLT 14 AMP-HOUR	0870060-1	27.0	-4.5
C01-R-2	BATTERY 24 VOLT 14 AMP-HOUR	C614001-0101	22.8	-4.5
C01-O	BATTERY 24 VOLT 17 AMP-HOUR	C614001-0102	24.0	-4.5
C04-R	REGULATOR SERVICE PLUG RECEPTACLE	C611002-0105	20.5	-0.7
C07-A	ELECTRIC ELEVATOR TRIM INSTL	2270003-1	3.1	-2.5
C10-A	DRIVE ASY REGULATOR	2270007-1	4.3	-2.7*
	VOLT. REGULATOR (EXCHANGE)	I260153-3	3.0	217.0
	ACTUATOR ASY (EXCHANGE)	C611003-0101	3.3	221.0
C19-O	HEATING SYSTEM, PITOT & STALL WARNING	1260074-7	0.0	216.0
	HEATING SWITCH	0770724-3	0.5	26.5
C22-A	LIGHTS, INSTRUMENT POST	2201003	0.5	17.5
C23-A	PANEL LIGHTS, ELECTRO-LUMINESCENT	0770419	2.1	16.5
C31-A	LIGHTS, COURTESY (NET CHANGE)	0700615-11	0.5	61.7
C34-S	FUEL PUMP, AUX NAVIGATION LIGHT (SET OF 2)	C291506-0101	1.8	-1.2
C40-A	OMNI FLIGHT ASSY (IN FIN TIP)	0701013-1, -2	NEG	-
C43-A	FLASHER ASSY (IN FIN TIP)	0701042-3	1.7	208.6*
	LOADING RESISTOR (NET CHANGE)	C621001-0102	0.4	253.0
C46-A	STROBE LIGHTS INSTL.	C594502-0102	0.2	253.0
	POWER SUPPLY INSTL.	CR95-6	3.5	212.0
	OPT WING TIPS (0723200-26, -27) REPLACES	0701018-4 & -6	3.4	44.4
	STD TIPS (072300-14, -15) WHICH			
	INCLUDES LIGHT ASY (SET OF TWO)			
C49-S	POWER UNIT (SET OF TWO)	C622006-0101	0.4	42.0
	LIGHT INSTL, COWL MOUNTED LANDING & TAXI	C622008-0102	2.4	46.7
	LIGHT BULBS (SET OF 2)	2270002	1.6	-28.1
		GE-4591	1.0	-37.0

SECTION 6  
WEIGHT & BALANCE/  
EQUIPMENT LIST

CESSNA  
MODEL R182

ITEM NO	EQUIPMENT LIST DESCRIPTION	REF DRAWING	WT LBS	ARM INS
	D. INSTRUMENTS			
D01-R	INDICATOR, AIR SPEED	C661064-0217	0.6	16.0
D01-O	INDICATOR, TRUE AIR SPEED (NET CHANGE)	1201108-112	0.2	16.5
D04-A	STATIC ALTITUDE AIR SOURCE	0701028-1	0.3	14.4
D07-R-1	ALTITUDE SENSITIVE (FEET & MILLIBARS)	C661071-0101	1.0	15.3
D07-O-2	ALTITUDE SENSITIVE (20 FT. MARKINGS)	C661071-0102	1.0	15.3
D10-A-1	ALTITUDE SENSITIVE (20 FT. MARKINGS)	C661025-0102	1.0	15.3
D16-A-1	ENCODING ALTITUDE INCHES HG. (REQUIRES RELOCATING ALTITUDE INCHES)	1213681-1	1.0	16.0
D16-A-2	ENCODING ALTITUDE INCHES HG. (REQUIRES RELOCATING ALTITUDE INCHES)	1213732	3.0	14.0
D16-A-3	ALTITUDE ENCODER (BLIND)	0701099-5	5.2	13.6
D22-A	GAGE, CARBURETOR AIR TEMPERATURE	2201905-1	1.0	15.6
D25-S	ELECTRIC MAGNETIC & MOUNT	C664508-0101	1.0	16.5
D34-R	COMPARISON INSTRUMENT ENGINE & FUEL	1213679-3	1.0	20.5
D49-A	INDICATOR INSTALLATION, ECONOMY MIXTURE	C669502-0211	1.0	18.2*
	EGT INDICATOR	0750609-3	0.4	17.1
	TFERMOCOUPLE PROBE WIRE (IC)	C668501-0211	0.0	17.5
	TFERMOCOUPLE LEAD (NON ALT-C-PILOT)	C668501-0204	0.0	20.3*
D64-S	GYRO SYSTEM INST. GATOR	C668501-0206	0.0	13.3*
	DIR SYSTEM INST. GATOR	0701030-2	5.9*	13.1
	ATTITUDE INDICATOR	C661075-0101	2.2	14.4
	HOUSES FITTINGS, SCREWS, CLAMPS ETC.	C661075-0102	2.2	14.4
D64-O-1	GYRO SYSTEM INST. GATOR	0701038-1	1.6	13.0*
	AUTOPILOT			
	DIRECTIONAL INDICATOR	40760	3.2	13.0
	ATTITUDE INDICATOR	C661076	3.2	14.4
D64-O-2	ATTITUDE INDICATOR WITH MOVABLE HEADING	1201126	3.1	14.1
	DIRECTIONAL INDICATOR WITH MOVABLE HEADING			
	INDEX POSITIONER, REPLACES STD DIRECTIONAL			
	D64-S AND REPLACES STD DIRECTIONAL			
D67-A	INDICATOR, IN STALLATION	2201004-1	0.6*	7.8*
	INDICATOR, IN STALLATION	C664502-0101	0.2	1.4
D73-R	RECORDING INDICATOR	S1711-1	0.2	1.0
D82-S	OIL PRESSURE SWITCH	C662035-0101	0.9	15.8
D85-R	GAGE, MANIFOLD PRESSURE	C668507-0101	0.1	28.5*
	GAGE, OUTSIDE AIR TEMPERATURE	2206001	0.9*	13.8*
	TACHOMETER IN STALLATION, ENGINE			

ITEM NO	EQUIPMENT LIST DESCRIPTION	REF DRAWING	WT LBS	ARM INS
D88-S	RECORDING TACH INDICATOR	C668020-0117	0.7	16.9
D88-O-1	TACH FLEXIBLE SHAFT (CASE S 1605-24)	S-1605-2	0.2	13.0
D91-S	INDICATOR, TURN COORDINATOR (FOR N.O.M. *S)	C661003-0505	1.3	15.0
	INDICATOR, TURN COORDINATOR	42320-0028	1.3	15.0
	INDICATOR, RATE OF CLIMB	C661080-0101	1.0	15.4
	E. CABIN ACCOMMODATIONS			
E05-R	SEAT, ADJUSTABLE FORE & AFT - PILOT	1214124-1	13.0	44.5
E05-O	SEAT, ARTICULATING VERT. ADJ. - PILOT	1214125-1	13.0	41.5
E07-S	SEAT, ADJUSTABLE FORE & AFT - CO-PILOT	1214124-2	13.0	41.5
E07-O	SEAT, ARTICULATING VERT. ADJ. - CO-PILOT	1214125-2	13.0	41.5
E09-S	SEAT, 2ND ROW BENCH, AUXILIARY (CHILDS)	2201001-1	23.8	80.5
E11-A	SEAT, INSTALATION, FOLD AWAY (120 LB MAX CAP.)	0714050-1	6.9	103.4
E15-R	BELT ASSY, LAP (PILOT SEAT)	S1746-5	0.9	104.1
E15-S	SHOULDER HARNESS ASSY, PILOT	S2275-3	1.0	101.0
E19-O	PILOT & CO-PILOT INERTIA REEL INSTL. (NET CHANGE)	S2275-201	0.6	37.0
E23-S	BELT & SHOULDER HARNESS ASSY, CO-PILOT	S2275-3	1.6	37.0
E27-S	BELT ASSY, 2ND ROW OCCUPANTS (SET OF 2)	S1746-40 & -41	1.6	74.5
E27-O	SHOULDER HARNESS INSTL. REAR SEAT (EXCHANGE)	0701026-1	1.8	74.5
E35-A-1	INTERIOR, VINYL SEAT COVERS (NET CHANGE)	CES-1154	0.0	3.0
E35-A-2	INTERIOR, LEATHER SEAT COVERS (NET CHANGE)	CES-1154	0.0	3.0
E37-A	OPENABLE WINDOW, REAR (NET CHANGE)	0701017-8	2.3	47.5
E39-A	WINDSHIELD, REAR (NET CHANGE)	0701017-4	4.6	45.3
E43-A	WINDSHIELD, FRONT (NET CHANGE)	0701084-1	0.9	62.0
E49-A	CUP HOLDER, 1ST ROW (SET OF 2)	1201124-1	0.0	16.0
E51-A	HEADREST, 1ST ROW (INSTALLED ARM) (EACH)	1215073-1	0.0	147.0
E53-A	MIRROR, 1ST ROW (INSTALLED ARM) (EACH)	1201041-1	0.0	87.0
E55-S	SUN VISOR, EAR VIEW (SET OF 2)	1201024-1	0.3	16.0
E59-A	APPROACH PLATE HOLDER	0715046-1	0.0	13.0
E65-S	BAGGAGE TIE DOWN NET	1215042-1	1.0	37.5
E85-A	CONTROL WHEEL - ALL PURPOSE MAP LIGHT, DUAL (CO-PILOT) (EXCHANGE)	1215042-1	0.8	27.0
E89-O	CONTROL WHEEL - ALL PURPOSE MAP LIGHT, PILOT ONLY - INCLUDES MAP LIGHT, (EXCHANGE)	1260101-9	0.8	22.0
		1260243	NEG	16.1

SECTION 6  
WEIGHT & BALANCE/  
EQUIPMENT LIST

CESSNA  
MODEL R182

ITEM NO	EQUIPMENT LIST DESCRIPTION	REF DRAWING	WT LBS	ARM INS
E93-R	MIC SWITCH, AND PANEL MOUNTED AUX MIC JACK HEATING SYSTEM, CABIN & CARBURETOR AIR	2206001	13.5	-4.8
F01-R	F. PLACARDS & WARNING			
F01-0-1	PLACARD, OPERATIONAL LIMITATIONS-VFR DAY	2205001-1	NEGL	-
F01-0-2	PLACARD, OPERATIONAL LIMITATIONS-VFR DAY-NIGHT	2205001-2	NEGL	-
F04-R	PLACARD, OPERATIONAL LIMITATIONS-IFR DAY-NIGHT INDICATOR, STALL WARNING UNIT (USES RADIO SPEAKER FOR AUDIBLE TCNES)	2205001-3 1270733-1	NEGL 0.3	- 45.0
G01-A	G. AUXILIARY EQUIPMENT			
G07-A	TAILCONE LIFT HANDLES (SET OF 2)	0712033-1	1.0	186.5
G13-A	HOISTING RINGS (DEALER INSTALLED)	0700612-1	1.5	45.0
G16-A	CORROSION PROOFING, INTERNAL	0760007-2	7.1	70.0
G19-A	STATIC DISCHARGERS (SET OF 10)	1201131-1	0.4	130.5
G22-S	STABILIZER ABRASION BOOTS	0500041-2	2.7	206.0
G25-S	TOWBAR, AIRCRAFT (STOWED ARM SHOWN) PAINT, OVERALL COVER-EXTERIOR OVERALL WHITE BASE (1C2773 SQ IN) WASH PRIME COLORED STRIPE	0501019-1 2204000	1.6 13.1*	90.9*
G28-S	JACK PADS (SET OF 2) INSTALLED	2222001	0.5	91.5
G31-A	CABLES, CORROSION RESISTANT (NET CHANGE)	0760007-2	0.6	79.8
G55-A-1	FIRE EXTINGUISHER, HAND TYPE (FOR USE WITH STANDARD PILOT SEAT)	0701014-1	0.2	37.0
G55-A-2	FIRE EXTINGUISHER, HAND TYPE (FOR USE WITH VER TICAL ADJUSTING PILOT SEAT)	0701014-2	0.0	-
G67-A	RUDDER PEDAL ADJUSTING PISTONS (DEALER INSTL.)	0701048-1	3.1	35.0
G89-A	WINNERIZATION KIT, ENGINE	2201302-1	3.5	29.0
G92-A	WINGS, EXTENDED RANGE FUEL (NET CHANGE)	0720700-11 &-12	2.3 0.3*	7.0 -40.0



ITEM NO	EQUIPMENT LIST DESCRIPTION	REF DRAWING	WT LBS	ARM INS
H01-A-1	CESSNA 300 ADF WITH BFO RECEIVER & INDICATOR INSTL RECEIVER R-546E INDICATOR MOUNT-XCYR LOOP ANTENNA INSTL ANTENNA	3910159-20 3930105 41240-0101 40980-0000 3960104-1 41000-1000 3950136 3910160 43090-1114 40980-1001 3960104-1 0770750	8.1* 5.2* 3.3 1.5 1.5* 1.4 1.4* 3.4 3.0 2.0 1.7 1.6 4.9*	23.0* 15.0* 15.0 15.0 32.6* 24.8* 21.6* 16.5 13.4 96.2 17.0 15.5*
H01-A-2	CESSNA 400 ADF (WIBFO) ADF RECEIVER WITH BFO (R-446A) CONJOMETER INDICATOR (IN-346A) ADF LOOP ANTENNA & ASSOC. WIRING ADF SENSE ANTENNA MOUNT BOX & INSTL. ITEMS DME INSTL. NARCO DME 19C	3910166-11 3930165-1 3312-400 3960133-1 3930152-7 3950136 3910167-18	0.2 0.1 0.8 14.8*	188.0 6.5 79.2 104.4
H04-A-1	CESSNA 400 DME INSTL WITH SINGLE NAV/COM) RECEIVER-TRANSMITTER INSTL RCVR-XMTR MOUNT ANTENNA INSTL CONTROL UNIT INSTL. CONTROL UNIT MOUNT WIRING	3940234-1 44000 44088 3960134-1 3930168-1 44020-1100 41038-0000 3950136 3910167-19	9.7* 8.9 0.8 0.2 1.8* 1.5 3.1 14.8*	133.8* 188.0 14.5* 14.0 17.0 58.0 104.3*
H04-A-2	CESSNA 400 DME INSTL WITH SINGLE NAV/COM) RECEIVER-TRANSMITTER INSTL RCVR-XMTR MOUNT ANTENNA INSTL CONTROL UNIT INSTL. CONTROL UNIT MOUNT WIRING	3940234-1 44000 44088 3960134-1 3930168-1 44020-1100 41038-0000 3950136 3910167-19	9.7* 8.9 0.8 0.2 1.8* 1.5 3.1 14.8*	133.8* 188.0 14.5* 14.0 17.0 58.0 104.3*
H04-A-3	CESSNA 400 DME (USED WITH DUAL NAV/COM) SAME AS H04-A-2 EXCEPT FOR WIRE CABLES W/ SINGLE N/C W/ DUAL N/C	3910168 3930170-4 44100-1100 44091-0000 3930176-16 3930182-8 OR -9	6.7* 4.5 5.2 3.8 1.3 1.1	12.9* 11.6 12.5 12.5 18.0 15.5
H05-A	COMPUTER INSTL (RN-478A) COMPUTER MOUNT PHOTOCELL INSTL. INDICATOR INSTL. 43910-1000 IND. USED WITH EITHER 300 OR 400 N/C + 4688C-1310 IND. USED	3910168 3930170-4 44100-1100 44091-0000 3930176-16 3930182-8 OR -9	6.7* 4.5 5.2 3.8 1.3 1.1	12.9* 11.6 12.5 12.5 18.0 15.5

SECTION 6  
WEIGHT & BALANCE/  
EQUIPMENT LIST

CESSNA  
MODEL R182

ITEM NO	EQUIPMENT LIST DESCRIPTION	REF DRAWING	WT LBS	ARM INS
	WITH 400 N/C ONLY INDICATOR INSTL. W/ DUAL N/C 43910-1000 IND. REPLACES 46860-1000 IND. IN EITHER 300 OR 400 N/C 46880-1000 REPLACES 46860-1000 IN 400 N/C ONLY	3980182-8 OR -9	-1.1	15.5
H07-A-1	CABLE INSTL. CESSNA 400 GLIDESLOPE RECEIVER R-443B MOUNT VOR/ILS INDICATOR IN-386A (EXCHANGE) ANTENNA INSTL (MOUNTED CN WINDSHIELD) WIRING	3950136 3910157-11 42100-0000 36450-0000 46860-2000 3960119-4 3950136	0.4 4.6* 2.1 0.3 0.1 0.3* 1.8	10.0 88.9* 132.4 15.5 29.6* 44.0
H07-A-2	CESSNA 400 GLIDESLOPE WITH 300 VOR/ILS INDICATOR (IN-386A) WITH AUTOMATIC RADIAL CENTERING REPLACES IN-386A INDICATOR - WT. CHANGE IS NEG.			
H09-A	FSI INSTL. UNSLAVED MOUNT INDICATOR MOUNT VOR/LOC CONVERTER INSTL. CONVERTER MOUNT	3910195-5 3930195-1 44690-2000 41038-0000 3940252-1 47240-0000 43270-0000 3950136 3910193-8 3930111-2 C582103-0102 3940233-1 C582103-0301 3940228-1 C589502-0201 2270006-1*-2 3950136 3910158-39 3930112-1 99681 3940226-1 99683 99916 3940227-1	7.5* 5.2* 4.9 0.3 1.1* 0.9 0.2 0.2 1.3* 3.9* 3.8 8.5* 8.4 4.4* 4.2 0.3 0.3 22.7* 4.4* 4.3 9.8* 8.5 0.8 5.4*	38.4* 14.0-  132.1*  55.0 103.6 14.0* 132.0* 144.5*  152.1 62.1 100.8 11.7* 130.0*  144.0*
H11-A-1	SECOND 300 HF UNIT - PANTRONICS TRANSCIEIVER INSTL. TRANSCIEIVER PANTRONICS PT10-A POWER SUPPLY INSTL. POWER SUPPLY PANTRONICS PT-10PS-28 ANTENNA LOAD BOX INSTL. LOAD BOX PANTRONICS DX-10RL-28 SUPPORT ASSY. ANTENNA INSTL.			
H11-A-2	SECOND 300 HF UNIT - SUNAIR TRANSCIEIVER INSTL. TRANSCIEIVER ASB-125 POWER SUPPLY INSTL. POWER SUPPLY PA1010A MOUNT ANTENNA LOAD BOX INSTL.			

ITEM NO	EQUIPMENT LIST DESCRIPTION	REF DRAWING	WT LBS	ARM INS
H12-A-1	ANT. COUPLER CU-110 SUPPORTS ANTENNA INSTL WIRING 300 HF INSTL- PANTRONICS TRANSMITTER INSTL POWER SUPPLY INSTL ANT. LOAD BOX INSTL. (SEE ITEM HI1-A-1 FOR BREAKDOWN OF THE ANTENNA INSTL.S) ANTENNA INSTL. (560117-2 IS USE ONLY WITH ADF) SWITCH INSTL. WIRING 300 HF INSTL. SUNAIR (SAME AS ITEM HI1-A-2 EXCEPT THAT 570135-1 SWITCH INSTL. IS ADDED, SEE ITEM HI2-A-1 FOR WT. & CG OF SWITCH INSTL.) CESSNA 400 MARKER BEACON RECEIVER INSTL ANTENNA INSTL (R-402A) CONTROL PANEL INSTL (THESE PARTS INSTALLED IN AUDIO PNL) WIRING 300 TRANSPONDER CESSNA 300 TRANSPONDER TRANSMITTER INSTL TRANSMITTER (RT-359A) MOUNT & SUPPORTS ANTENNA INSTL WIRING 400 TRANSPONDER CESSNA 400 TRANSPONDER (SAME AS ITEM HI6-A-1 EXCEPT 3930132-15 RT-459A XCVR INSTL CHANGE) REPLACES 3930132-15, NEG. WT. CHANGE) RECEIVER/COM, 720 CHANNEL COM VOR/LOC 300 TRANSMITTER (IN-385A) RECEIVER-INDICATOR (KIT VOR/LOC INDICATOR (IN-385A) F34-A BASIC AVIONICS KIT MOUNT, WIRING & MISC. HARDWARE FIRST 400 NAV/COM, 720 CHANNEL COM VOR/LOC	99816 2270006-1,-2 3960117-1 3950136 3910193-9 3930111-2 3940233-1 3940228-1  3960117-2 OR -3  3970135-1 3950136 3910158-40	5.2 0.3 0.3 19.4* 3.9 8.5 4.4  0.3 0.2 2.2 22.9*	152.1 50.7 102.5* 14.0 132.0 144.5  152.1 17.0 62.1 100.3*
H12-A-2				
H13-A				
H16-A-1				
H16-A-2				
H22-A-1				
H22-A-2				



ITEM NO	EQUIPMENT LIST DESCRIPTION	REF DRAWING	WT LBS	ARM INS
F25-A-5	EXCHANGE FOR IN-385A , NEG. WEIGHT SECOND 400 NAV/COM WITH OPTICAL INDICATOR IN-385AC (AUTOMATIC RADIAL CENTERING) EXCHANGE FOR IN-385A , NEG. WEIGHT	0470419-23 C589511-0103 C589511-0105 C589511-0109 0470419-24	2.7* 1.7 0.6	134.6* 134.5
H28-A-1	EMERGENCY LOCATOR TRANSMITTER TRANSMITTER ASY.	0470419-24	2.8*	134.6*
H28-A-2	EMERGENCY LOCATOR TRANSMITTER (USED IN CANADA)	C589511-0104 C589511-0105 C589511-0109	1.7 0.1 0.2*	134.5
H31-A-1	ANTENNA BATTERY PACK NAV-O-MATIC 2CCA INSTALLATION (AF-295B) CONTROLLER-AMPLIFIER TURN COORDINATOR (D88-0-1) (NET CHANGE)	3910162-24 43610-1201 42320-0028 0700215	8.2* 1.1 NEG 6.3*	54.8* 15.0
H31-A-2	WING SERVO INSTALLATION (AF-395-A) NAV-O-MATIC 30CA INSTALLATION (AF-395A) CONTROLLER-AMPLIFIER (NET CHANGE) GYRO INSTALLATION (REPLACES ITEM D64-S) (ITEM D64-0-1 REPLACES ITEM D64-S) TURN COORDINATOR (D88-0-1) (NET CHANGE)	3910163-24 42660-1201 0701038-1 42320-0028 0700215-4 3910186-14	9.3* 1.4 0 NEG 6.5*	65.6 50.0* 15.0 14.5
H34-A	BASIC AVIONICS KIT WING SERVO INSTALLATION MIC AVIONICS KIT BUS BAR INSTALLATION NOISE FILTER INSTL. OMNI ANT. INSTL. VHF ANT. INSTL. PANEL INSTL. AUDIO CONE INSTL. FEADPHONE INSTL. MICROPHONE INSTL. ANTENNA ADAPTOR INSTL. COMPONENTS FIRST NAV/COM INSTL. CMNI ANT. S CABLE INSTL. RH VHF & CMNI ANT. S RADIO COOLING INSTL. ANTENNA & NAV COUPLER KIT ANTENNA & NAV COUPLER KIT (REQUIRED FOR & AVAILABLE ONLY WITH SECOND NAV/COM) SECOND NAV/COM INSTL. KIT	3930148-2 3960102-6 3960113-2 3970131-1 3970137-2 3940247-1 3970139-1 3960139-1 3930186-6 3950136 3930152-5 3910185-12 3930186-7	NEG 6.3 6.5* NEG 0.7 0.5 0.9 1.2 0.3 0.3 0.2 0.1 1.4 1.0 1.1* 0.1	65.6 61.9* -31.0 263.4 12.5 14.6 -15.0 18.5 17.0 10.3 108.3 12.5 137.1 11.0
H37-A	COM (REQUIRED FOR & AVAILABLE ONLY WITH SECOND NAV/COM) SECOND NAV/COM INSTL. KIT	3930186-7	0.1	11.0

SECTION 6  
WEIGHT & BALANCE/  
EQUIPMENT LIST

CESSNA  
MODEL R182

ITEM NO	EQUIPMENT LIST DESCRIPTION	REF DRAWING	WT LBS	ARM INS
H46-A	LH VHF ANTENNA INSTL.	3960113-1	0.5	63.4
H52-A	ANTENNA COUPLER INSTL. CABLE IN STL. ANTENNA ANT. ADAPTOR INSTL. REMOVED ADF ANTI PRECIP SENSE ANTENNA (CGM ANTENNA) AVIONICS OPTION G (FLASH MTD CGM ANTENNA) (FLUSH OPTION IN LEADING EDGE VERTICAL FIN FEACSET-MICROPHONE, PADDED (STOWED) CABIN SPEAKER (REQUIRED AS PART OF STALL WARNING SYS.)	3960111-1 3950136-1 3960139-1 3910154-64 3910154-63 C596531-0101 C596510-0101	0.43 0.32 -0.28 1.4	10.8 17.0 141.8 184.6
H56-A			1.1	14.0
H51-R			1.9	45.1
J01-A	J. SPECIAL OPTION PACKAGES  SKYLANE RG II KIT C07-A GROUND SERVICE RECEPTICLE C19-0 HEATED PITOT & STALL WARNING C31-0 COURTESY ENTRANCE LIGHTS (2) C40-A NAV LIGHT DETECTORS C42-A FLASHING BEACON LIGHT C01-0 TRUE AIR SPEED IND. (NET CHANGE) C04-A STALL CONTROL WINGS D04-A DUAL RANGE ADF (R-546E) E02-A LONG RANGE ADF (R-546E) E01-A-1 CESSNA 300 TRANSPONDER (RT359A) F01-A-1 CESSNA 300 NAV/CCM (RT-385A) F16-A-1 FIRST 300 LOCATOR TRANSMITTER F28-A-1 EMERGENCY LOCATOR PILOT CHANGE) F31-A-1 CESSNA 200A AUTO-PILOT CHANGE) NAV-PAC (SKYLANE RG II ONLY) SECTION FOR SEE INITIATION OF NAV-PAC H07-A 400 GLIDESLOPE (R-443B) H13-A 400 MARKER BEACON (R-402A) H25-A-1 SECOND 300 NAV/CCM (RT-385A)	SECTICN 9.1 2270003-1 0770724-3 0700615-11 &-2 0701013-1 &-2 0701042-3 1201008-12 0701028-1 0760101-4 0720700-11 &-12 3910159-20 3910127-28 3910183-20 0470419-23 3910162-24  3910157-11 3910164-12	59.2* 3.25 0.55 NEGL 1.8 0.237 8.7 8.01 8.28 13.7 8.2 16.7*  4.6 2.9	42.8* -2.6 26.5 61.7 - 208.5 16.4 14.4 16.15 23.4 17.42 136.6 134.8 44.9  88.9 70.8 16.0
J04-A				

# SECTION 7

## AIRPLANE & SYSTEMS DESCRIPTIONS

### TABLE OF CONTENTS

	Page
Introduction . . . . .	7-3
Airframe . . . . .	7-3
Flight Controls . . . . .	7-8
Trim System . . . . .	7-8
Instrument Panel . . . . .	7-8
Ground Control . . . . .	7-9
Wing Flap System . . . . .	7-10
Landing Gear System . . . . .	7-11
Landing Gear Lever . . . . .	7-11
Landing Gear Position Indicator Lights . . . . .	7-12
Landing Gear Operation . . . . .	7-12
Emergency Hand Pump . . . . .	7-12
Landing Gear Warning System . . . . .	7-13
Baggage Compartment . . . . .	7-13
Seats . . . . .	7-13
Seat Belts And Shoulder Harnesses . . . . .	7-14
Seat Belts . . . . .	7-15
Shoulder Harnesses . . . . .	7-15
Integrated Seat Belt/Shoulder Harnesses With Inertia Reels . . . . .	7-17
Entrance Doors And Cabin Windows . . . . .	7-17
Control Locks . . . . .	7-18
Engine . . . . .	7-18
Engine Controls . . . . .	7-19
Engine Instruments . . . . .	7-19
New Engine Break-In And Operation . . . . .	7-20
Engine Oil System . . . . .	7-21
Ignition-Starter System . . . . .	7-21
Air Induction System . . . . .	7-22
Exhaust System . . . . .	7-22
Carburetor And Priming System . . . . .	7-22
Cooling System . . . . .	7-23
Propeller . . . . .	7-23
Fuel System . . . . .	7-24

**TABLE OF CONTENTS (Continued)**

	Page
Hydraulic System, . . . . .	7-27
Brake System . . . . .	7-29
Electrical System . . . . .	7-29
Master Switch . . . . .	7-31
Avionics Power Switch . . . . .	7-31
Ammeter . . . . .	7-31
Over-Voltage Sensor And Warning Light . . . . .	7-32
Circuit Breakers And Fuses . . . . .	7-32
Ground Service Plug Receptacle . . . . .	7-32
Lighting Systems . . . . .	7-33
Exterior Lighting . . . . .	7-33
Interior Lighting . . . . .	7-34
Cabin Heating, Ventilating And Defrosting System . . . . .	7-35
Pitot-Static System And Instruments . . . . .	7-37
Airspeed Indicator . . . . .	7-38
Rate-Of-Climb Indicator . . . . .	7-38
Altimeter . . . . .	7-39
Vacuum System And Instruments . . . . .	7-39
Attitude Indicator . . . . .	7-39
Directional Indicator . . . . .	7-39
Suction Gage . . . . .	7-39
Stall Warning System . . . . .	7-41
Avionics Support Equipment . . . . .	7-41
Audio Control Panel . . . . .	7-41
Transmitter Selector Switch . . . . .	7-41
Automatic Audio Selector Switch . . . . .	7-43
Audio Selector Switches . . . . .	7-43
Microphone - Headset . . . . .	7-44
Static Dischargers . . . . .	7-44



## INTRODUCTION

This section provides description and operation of the airplane and its systems. Some equipment described herein is optional and may not be installed in the airplane. Refer to Section 9, Supplements, for details of other optional systems and equipment.

## AIRFRAME

The airplane is an all-metal, four-place, high-wing, single-engine airplane equipped with retractable tricycle landing gear, and designed for general utility purposes.

The construction of the fuselage is a conventional formed sheet metal bulkhead, stringer, and skin design referred to as semimonocoque. Major items of structure are the front and rear carry-through spars to which the wings are attached, a bulkhead with attaching plates at the base of the forward doorposts for the lower attachment of the wing struts, and the forgings and structure for the retractable main landing gear in the lower aft portion of the fuselage center section. Four engine mount stringers are also attached to the forward doorposts and extend forward to the firewall. A tunnel incorporated into the fuselage structure below the engine, in front of the firewall, is required for the forward retracting nose wheel.

The externally braced wings, containing the fuel tanks, are constructed of a front and rear spar with formed sheet metal ribs, doublers, and stringers. The entire structure is covered with aluminum skin. The front spars are equipped with wing-to-fuselage and wing-to-strut attach fittings. The aft spars are equipped with wing-to-fuselage attach fittings, and are partial-span spars. Conventional hinged ailerons and single-slot type flaps are attached to the trailing edge of the wings. The ailerons are constructed of a forward spar containing balance weights, formed sheet metal ribs and "V" type corrugated aluminum skin joined together at the trailing edge. The flaps are constructed basically the same as the ailerons, with the exception of balance weights and the addition of a formed sheet metal leading edge section.

The empennage (tail assembly) consists of a conventional vertical stabilizer, rudder, horizontal stabilizer, and elevator. The vertical stabilizer consists of a forward and aft spar, formed sheet metal ribs and reinforcements, four skin panels, formed leading edge skins, and a dorsal. The rudder is constructed of a forward and aft spar, formed sheet metal ribs and reinforcements, and a wrap-around skin panel. The top of the rudder incorporates a leading edge extension which contains a balance weight. The horizontal stabilizer is constructed of a forward and aft spar, ribs and

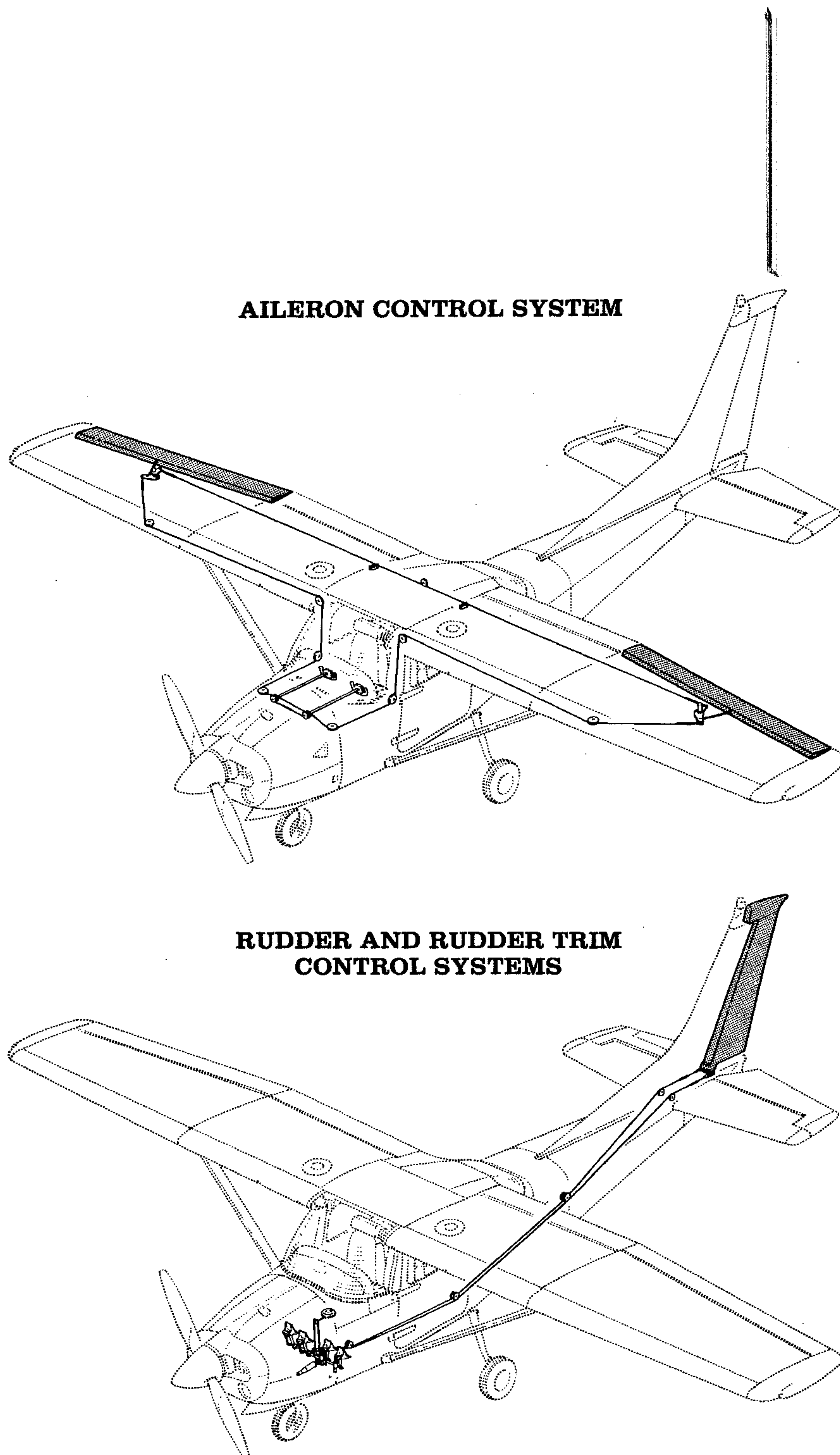
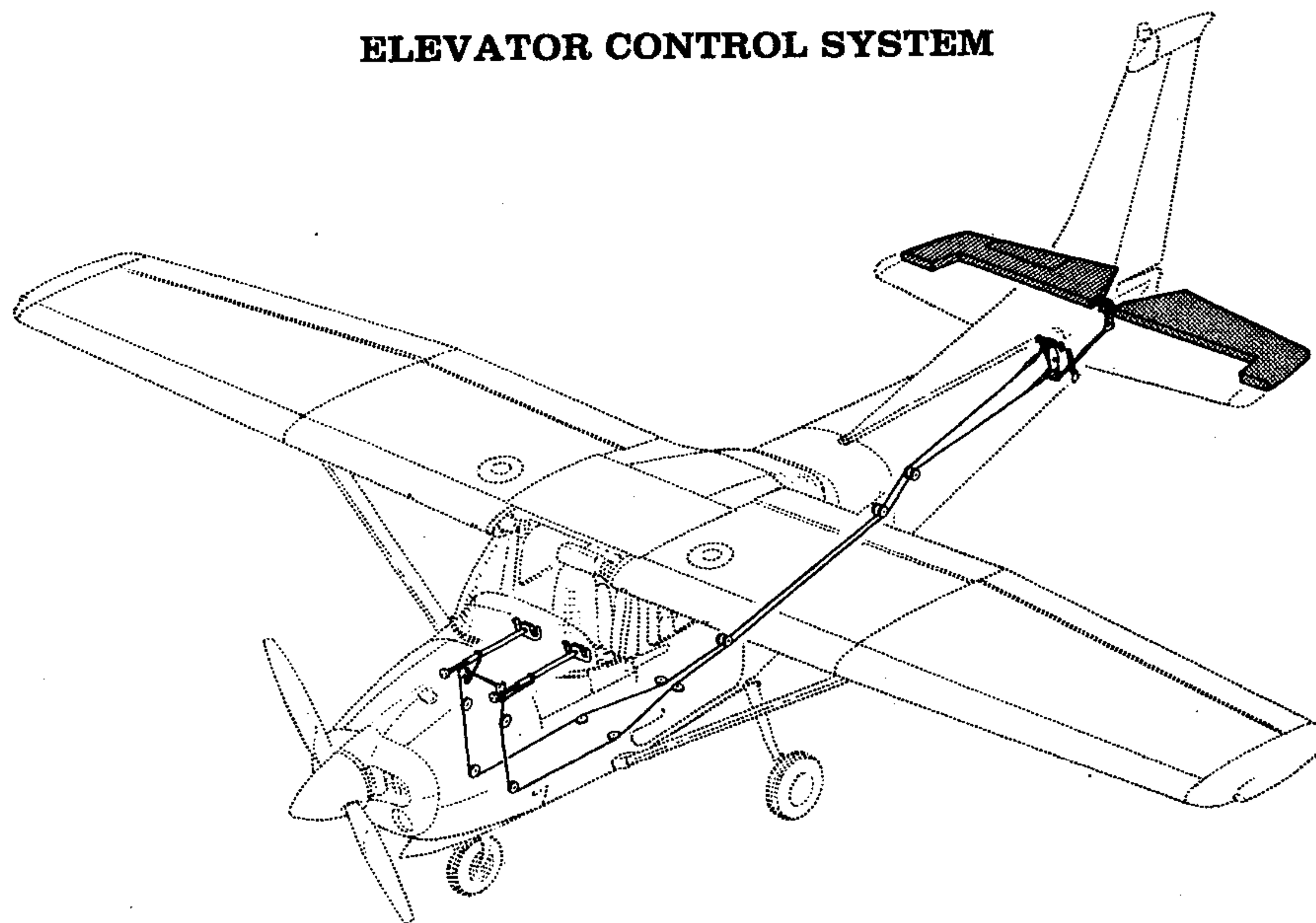

Figure 7-1. Flight Control and Trim Systems (Sheet 1 of 2)

**ELEVATOR CONTROL SYSTEM**



**ELEVATOR TRIM CONTROL SYSTEM**

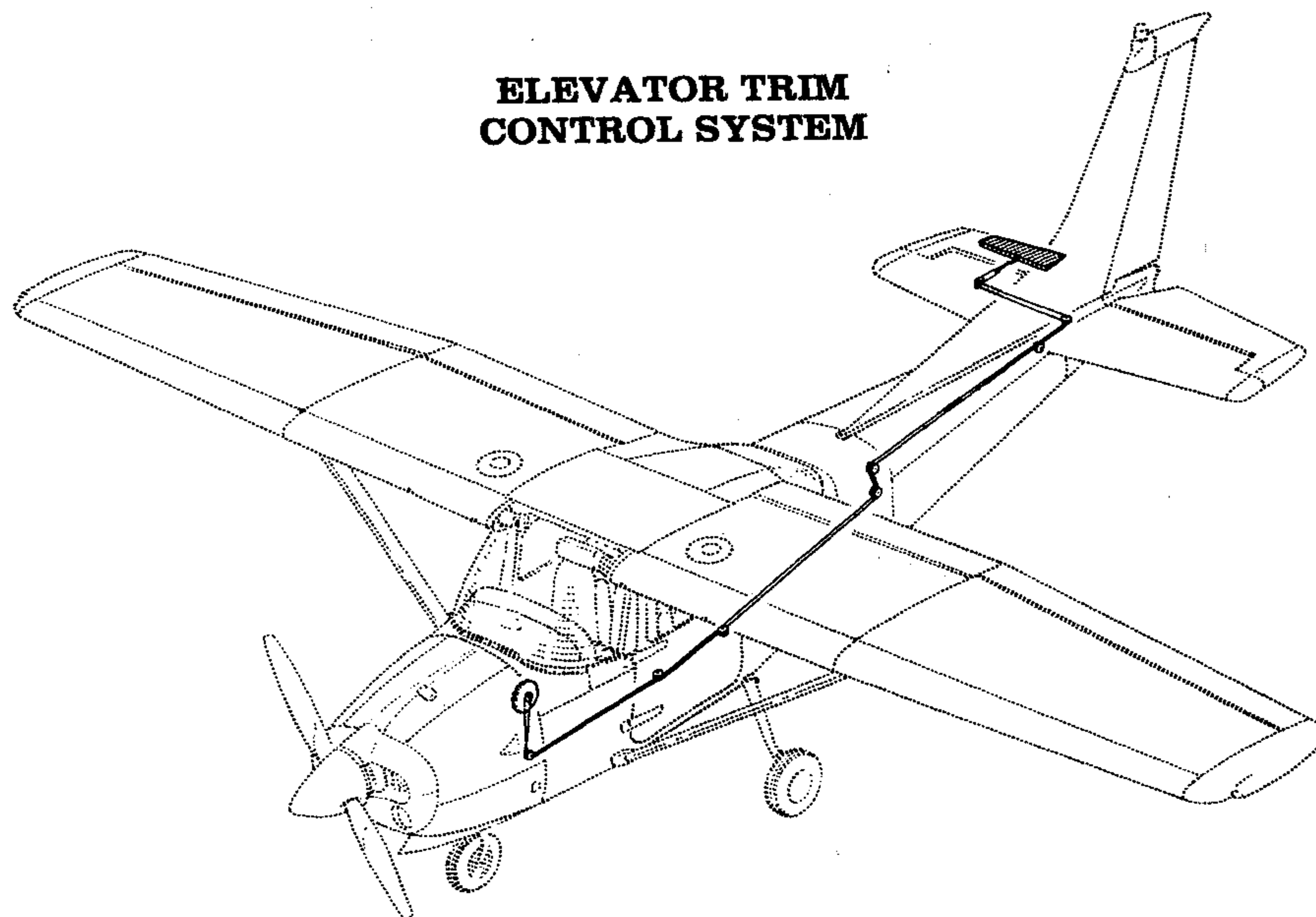

Figure 7-1. Flight Control and Trim Systems (Sheet 2 of 2)

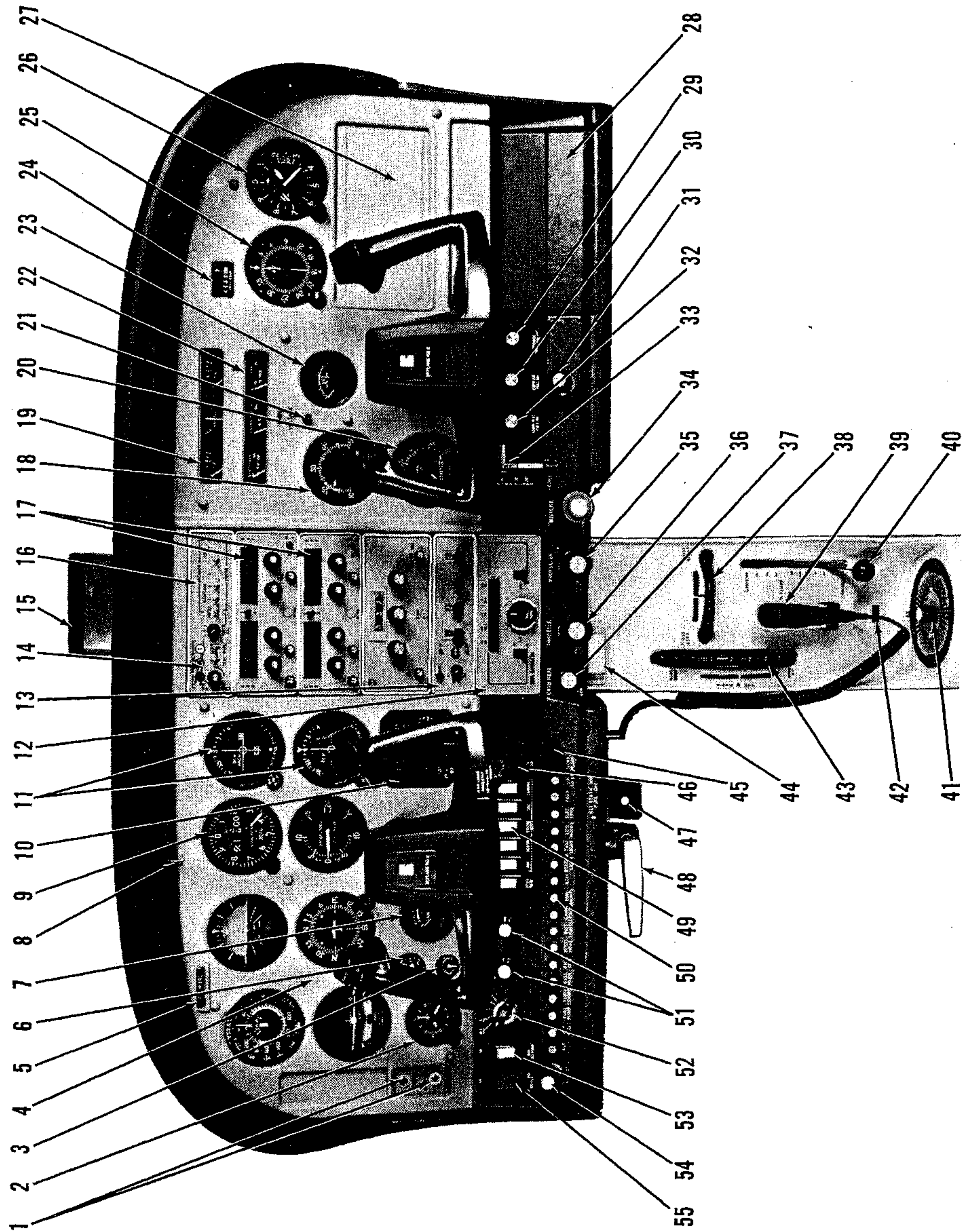

Figure 7-2. Instrument Panel (Sheet 1 of 2)

- |     |   |     |  |
|-----|---|-----|--|
| 1.  | Auxiliary Mike Jack and<br>Phone Jack                                 | 29. | Defroster Control Knob                     |
| 2.  | Clock   | 30. | Cabin Air Control Knob                     |
| 3.  | Suction Gage  | 31. | Cigar Lighter                              |
| 4.  | Flight Instrument Group   | 32. | Cabin Heat Control Knob                    |
| 5.  | Airplane Registration Number  | 33. | Wing Flap Switch and<br>Position Indicator |
| 6.  | Fuel Pressure Gage  | 34. | Mixture Control Knob                       |
| 7.  | Carburetor Air Temperature Gage                                       | 35. | Propeller Control Knob                     |
| 8.  | Approach Plate Light and Switch                                       | 36. | Throttle (With Friction Lock)              |
| 9.  | Encoding Altimeter  | 37. | Carburetor Heat Control Knob               |
| 10. | DME   | 38. | Rudder Trim Control Wheel                  |
| 11. | Omni Course Indicators  | 39. | Microphone                                 |
| 12. | Autopilot Control Unit  | 40. | Cowl Flap Control Lever                    |
| 13. | Transponder   | 41. | Fuel Selector Valve Handle                 |
| 14. | Marker Beacon Indicator<br>Lights and Switches                        | 42. | Fuel Selector Light                        |
| 15. | Rear View Mirror  | 43. | Elevator Trim Control Wheel                |
| 16. | Audio Control Panel   | 44. | Control Pedestal Light                     |
| 17. | Radios  | 45. | Landing Gear Lever                         |
| 18. | Manifold Pressure Gage  | 46. | Landing Gear Position<br>Indicator Lights  |
| 19. | Fuel Quantity Indicators and Ammeter                                  | 47. | Static Pressure Alternate<br>Source Valve  |
| 20. | Tachometer  | 48. | Parking Brake Handle                       |
| 21. | Over-Voltage Warning Light  | 49. | Electrical Switches                        |
| 22. | Cylinder Head Temperature, Oil<br>Temperature, and Oil Pressure Gages | 50. | Circuit Breakers                           |
| 23. | Economy Mixture Indicator   | 51. | Instrument and Radio Dial                  |
| 24. | Flight Hour Recorder  | 52. | Light Rheostat Control Knobs               |
| 25. | ADF Bearing Indicator   | 53. | Ignition Switch                            |
| 26. | Secondary Altimeter   | 54. | Auxiliary Fuel Pump Switch                 |
| 27. | Additional Radio and<br>Instrument Space                              | 55. | Primer                                     |
| 28. | Map Compartment   |     | Master Switch                              |

Figure 7-2. Instrument Panel (Sheet 2 of 2)

stiffeners, center upper and lower skin panels, and two left and two right wrap-around skin panels which also form the leading edges. The horizontal stabilizer also contains the elevator trim tab actuator. Construction of the elevator consists of formed leading edge skins, a forward spar, ribs, torque tube and bellcrank, left upper and lower "V" type corrugated skins, and right upper and lower "V" type corrugated skins incorporating a trailing edge cut-out for the trim tab. The elevator trim tab consists of a spar and upper and lower "V" type corrugated skins. Both elevator tip leading edge extensions incorporate balance weights.

## FLIGHT CONTROLS

The airplane's flight control system (see figure 7-1) consists of conventional aileron, rudder, and elevator control surfaces. The control surfaces are manually operated through mechanical linkage using a control wheel for the ailerons and elevator, and rudder/brake pedals for the rudder. The elevator control system is equipped with downsprings which provide improved stability in flight.

Extensions are available for the rudder/brake pedals. They consist of a rudder pedal face, two spacers and two spring clips. To install an extension, place the clip on the bottom of the extension under the bottom of the rudder pedal and snap the top clip over the top of the rudder pedal. Check that the extension is firmly in place. To remove the extensions, reverse the above procedures.

## TRIM SYSTEMS

Manually-operated rudder and elevator trim is provided (see figure 7-1). Rudder trimming is accomplished through a bungee connected to the rudder control system and a trim control wheel mounted on the control pedestal. Rudder trimming is accomplished by rotating the horizontally mounted trim control wheel either left or right to the desired trim position. Rotating the trim wheel to the right will trim nose-right; conversely, rotating it to the left will trim nose-left. Elevator trimming is accomplished through the elevator trim tab by utilizing the vertically mounted trim control wheel. Forward rotation of the trim wheel will trim nose-down; conversely, aft rotation will trim nose-up. The airplane may also be equipped with an electric elevator trim system. For details concerning this system, refer to Section 9, Supplements.

## INSTRUMENT PANEL

The instrument panel (see figure 7-2) is designed around the basic "T" configuration. The gyros are located immediately in front of the pilot, and

arranged vertically. The airspeed indicator and altimeter are located to the left and right of the gyros, respectively. The remainder of the flight instruments are located around the basic "T". The fuel pressure gage, suction gage and carburetor air temperature gage are located below the flight instruments, and to the left of the pilot's control column. Avionics equipment is stacked approximately on the centerline of the panel, with the right side of the panel containing the manifold pressure gage, tachometer, map compartment, and space for additional instruments and avionics equipment. The engine instrument cluster and fuel quantity indicators are on the right side of the avionics stack near the top of the panel. A switch and control panel, at the lower edge of the instrument panel, contains most of the switches, controls, and circuit breakers necessary to operate the airplane. The left side of the panel contains the master switch, engine primer, auxiliary fuel pump switch, ignition switch, light intensity controls, electrical switches, circuit breakers, landing gear indicator lights and landing gear lever. The center area contains the carburetor heat control, throttle, propeller control, and mixture control. The right side of the panel contains the wing flap switch and indicator, cabin heat, cabin air, and defroster control knobs and the cigar lighter. A pedestal, extending from the switch and control panel to the floorboard, contains the elevator and rudder trim control wheels, cowl flap control lever, and microphone bracket. The fuel selector valve handle is located at the base of the pedestal. A parking brake handle is mounted under the switch and control panel, in front of the pilot. A static pressure alternate source valve control knob may also be installed below the switch and control panel adjacent to the parking brake handle.

For details concerning the instruments, switches, circuit breakers, and controls on this panel, refer in this section to the description of the systems to which these items are related.

## GROUND CONTROL

Effective ground control while taxiing is accomplished through nose wheel steering by using the rudder pedals; left rudder pedal to steer left and right rudder pedal to steer right. When a rudder pedal is depressed, a spring-loaded steering bungee (which is connected to the nose gear and to the rudder bars) will turn the nose wheel through an arc of approximately 15° each side of center. By applying either left or right brake, the degree of turn may be increased up to 30° each side of center.

Moving the airplane by hand is most easily accomplished by attaching a tow bar to the nose gear strut. If a tow bar is not available, or pushing is required, use the wing struts as push points. Do not use the vertical or horizontal surfaces to move the airplane. If the airplane is to be towed by

vehicle, never turn the nose wheel more than 30° either side of center or structural damage to the nose gear could result.

The minimum turning radius of the airplane, using differential braking and nose wheel steering during taxi, is approximately 27 feet. To obtain a minimum radius turn during ground handling, the airplane may be rotated around either main landing gear by pressing down on a tailcone bulkhead just forward of the horizontal stabilizer to raise the nose wheel off the ground.

## WING FLAP SYSTEM

The wing flaps are of the single-slot type (see figure 7-3), and are extended or retracted by positioning the wing flap switch lever on the instrument panel to the desired flap deflection position. The switch lever is moved up or down in a slotted panel that provides mechanical stops at the 10° and 20° positions. For flap settings greater than 10°, move the switch lever to the right to clear the stop and position it as desired. A scale and pointer on the left side of the switch lever indicates flap travel in degrees.

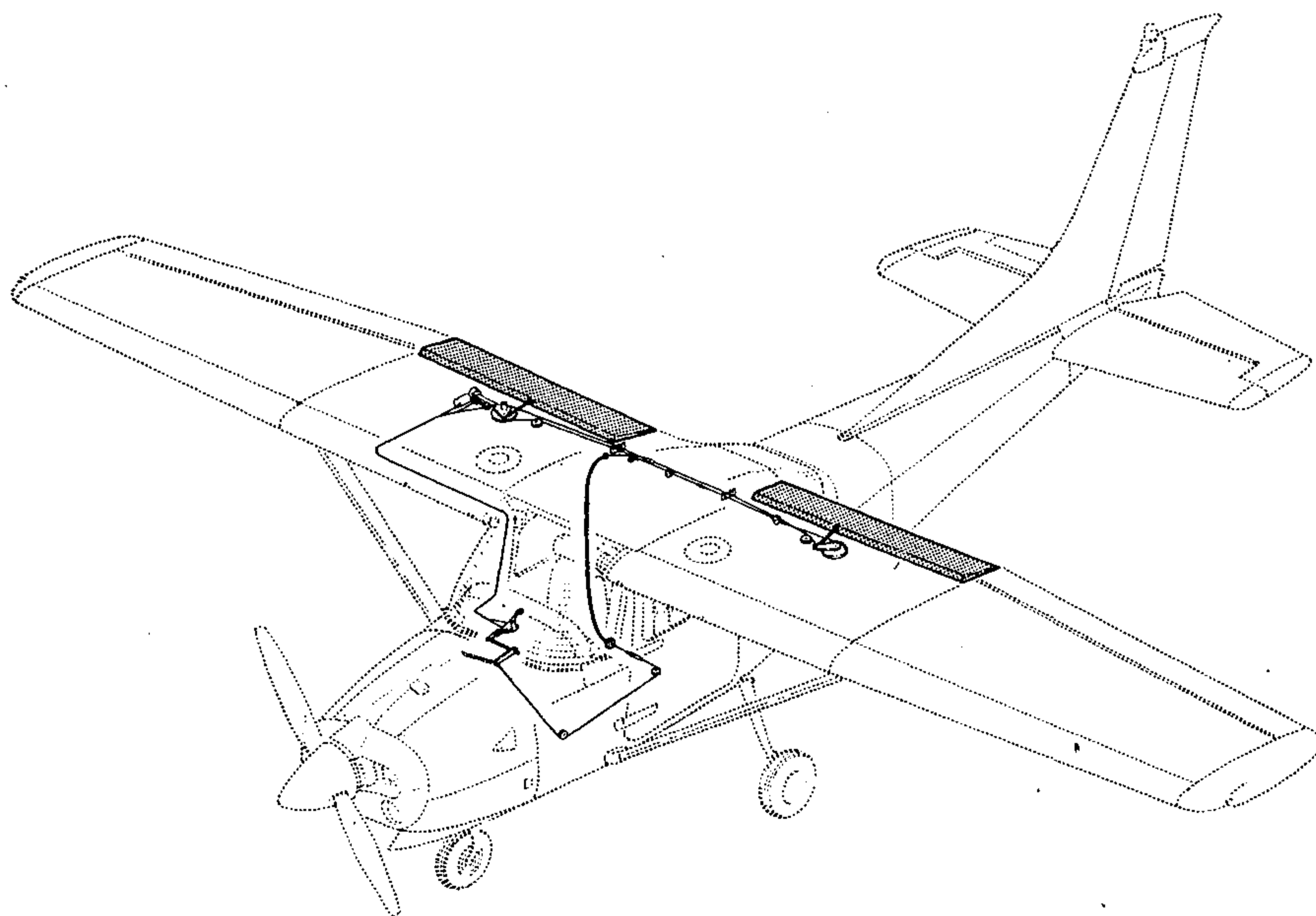

Figure 7-3. Wing Flap System



The wing flap system circuit is protected by a 15-ampere circuit breaker, labeled FLAP, on the left side of the switch and control panel.

A gear warning interconnect switch is incorporated in the flap system, and sounds a warning horn when the flaps are extended beyond 25° with the landing gear retracted.

## LANDING GEAR SYSTEM

The landing gear is a retractable, tricycle type with a steerable nose wheel and two main wheels. Shock absorption is provided by the tubular spring-steel main landing gear struts and the air/oil nose gear shock strut. Each main gear wheel is equipped with a hydraulically actuated disc-type brake on the inboard side of each wheel.

The landing gear extension, retraction, and main gear down lock operation is accomplished by hydraulic actuators powered by an electrically-driven hydraulic power pack (see figure 7-7). The power pack is located aft of the firewall between the pilot's and copilot's rudder pedals. The hydraulic system fluid level may be checked by utilizing the dipstick/filler cap located on the top right side of the power pack adjacent to the motor mounting flange. The system should be checked at 25-hour intervals, and anytime a hydraulic failure in the system requires the use of the emergency hand pump to extend the landing gear. If the fluid level is at or below the ADD line on the dipstick; hydraulic fluid (MIL-H-5606) should be added to maintain the level to the top of the dipstick / filler cap opening. A normal operating pressure of 1000 PSI to 1500 PSI is automatically maintained in the landing gear system, and is sufficient to provide a positive up lock pressure on the main landing gear. The nose gear incorporates an over-center mechanical linkage which provides a positive mechanical up and down lock. Mechanically-actuated wheel well doors are provided for the nose gear. The doors open when the nose gear extends, and close when it retracts.

Power pack operation is started and stopped by a pressure switch, and hydraulic pressure is directed by the landing gear lever. Two position indicator lights are provided to show landing gear position. The landing gear system is also equipped with a nose gear safety (squat) switch, an emergency extension hand pump, and a gear-up warning system.

## LANDING GEAR LEVER

The landing gear lever is located on the switch and control panel to the

right of the electrical switches. The lever has two positions, labeled GEAR UP and GEAR DOWN, which give a mechanical indication of the gear position selected. From either position, the lever must be pulled out to clear a detent before it can be repositioned; operation of the landing gear system will not begin until the lever has been repositioned. After the lever has been repositioned, it directs hydraulic pressure within the system to actuate the gear to the selected position.

### **LANDING GEAR POSITION INDICATOR LIGHTS**

Two position indicator lights, adjacent to the landing gear control lever, indicate that the gear is either up or down and locked. Both the gear-up (amber) and gear-down (green) lights are the press-to-test type, incorporating dimming shutters for night operation. If an indicator light bulb should burn out, it can be replaced in flight with the bulb from the remaining indicator light.

### **LANDING GEAR OPERATION**

To retract or extend the landing gear, pull out on the gear lever and move it to the desired position. After the lever is positioned, the power pack will create pressure in the system and actuate the landing gear to the selected position. During a normal cycle, the gear locks up or down, limit switches close, and the indicator light comes on (amber for up and green for down) indicating completion of the cycle. After indicator light illumination, the power pack will continue to run until the fluid pressure reaches 1500 PSI, opens the pressure switch, and turns the power pack off. Whenever fluid pressure in the system drops below 1000 PSI, the pressure switch will close and start power pack operation, except when the nose gear safety (squat) switch is open.

The safety (squat) switch, actuated by the nose gear, electrically prevents inadvertent retraction whenever the nose gear strut is compressed by the weight of the airplane. When the nose gear is lifted off the runway during takeoff, the squat switch will close, which may cause the power pack to operate for 1 to 2 seconds and return system pressure to 1500 PSI in the event pressure has dropped below 1000 PSI. A switch type circuit breaker is also provided in the system as a maintenance safety feature. With the switch pulled out, landing gear operation is prevented. After maintenance is completed, and prior to flight, the switch should be pushed back in.

### **EMERGENCY HAND PUMP**

A hand-operated hydraulic pump, located between the front seats, is provided for manual extension of the landing gear in the event of a hydraulic system failure. The landing gear cannot be retracted with the

hand pump. To utilize the pump, extend the handle forward, and pump vertically. For complete emergency procedures, refer to Section 3.

## **LANDING GEAR WARNING SYSTEM**

The airplane is equipped with a landing gear warning system designed to help prevent the pilot from inadvertently making a wheels-up landing. The system consists of a throttle actuated switch which is electrically connected to a dual warning unit. The warning unit is connected to the airplane speaker.

When the throttle is retarded below approximately 12 inches of manifold pressure at low altitude (master switch on), the throttle linkage will actuate a switch which is electrically connected to the gear warning portion of a dual warning unit. If the landing gear is retracted (or not down and locked), an intermittent tone will be heard on the airplane speaker. An interconnect switch in the wing flap system also sounds the horn when the wing flaps are extended beyond 25° with the landing gear retracted.

## **BAGGAGE COMPARTMENT**

The baggage compartment consists of the area from the back of the rear passenger seats to the aft cabin bulkhead. A baggage shelf, above the wheel well, extends aft from the aft cabin bulkhead. Access to the baggage compartment and the shelf is gained through a lockable baggage door on the left side of the airplane, or from within the airplane cabin. A baggage net with six tie-down straps is provided for securing baggage, and is attached by tying the straps to tie-down rings provided in the airplane. For further information on baggage tie-down, refer to Section 6. When loading the airplane, children should not be placed or permitted in the baggage compartment, and any material that may be hazardous to the airplane or occupants should not be placed anywhere in the airplane. For baggage area and door dimensions, refer to Section 6.

## **SEATS**

The seating arrangement consists of two separate adjustable seats for the pilot and front passenger, a split-backed fixed seat in the rear, and a child's seat (if installed) aft of the rear seats. The pilot's and front passenger's seats are available in two different designs: four-way and six-way adjustable.

Four-way seats may be moved forward or aft, and the seat back angle changed. To position either seat, lift the tubular handle under the center of the seat, slide the seat into position, release the handle, and check that the seat is locked in place. The seat back is spring-loaded to the vertical position. To adjust its position, lift the lever under the right front corner of the seat, reposition the back, release the lever, and check that the back is locked in place. The seat backs will also fold full forward.

The six-way seats may be moved forward or aft, adjusted for height, and the seat back angle is infinitely adjustable. Position the seat by lifting the tubular handle, under the center of the seat bottom, and slide the seat into position; then release the lever and check that the seat is locked in place. Raise or lower the seat by rotating a large crank under the right corner of the left seat and the left corner of the right seat. Seat back angle is adjustable by rotating a small crank under the left corner of the left seat and the right corner of the right seat. The seat bottom angle will change as the seat back angle changes, providing proper support. The seat backs will also fold full forward.

The rear passengers' seats consist of a fixed one-piece seat bottom with individually adjustable seat backs. Two adjustment levers, on the left and right rear corners of the seat bottom, are used to adjust the angle of the respective seat backs. To adjust either seat back, lift the adjustment lever and reposition the back. The seat backs are spring-loaded to the vertical position.

A child's seat may be installed aft of the rear passenger seats, and is held in place by two brackets mounted on the floorboard. The seat is designed to swing upward into a stowed position against the aft cabin bulkhead when not in use. To stow the seat, rotate the seat bottom up and aft as far as it will go. When not in use, the seat should be kept in the stowed position.

Headrests are available for any of the seat configurations except the child's seat. To adjust the headrest, apply enough pressure to it to raise or lower it to the desired level. The headrest may be removed at any time by raising it until it disengages from the top of the seat back.

## **SEAT BELTS AND SHOULDER HARNESSSES**

All seat positions are equipped with seat belts (see figure 7-4). The pilot's and front passenger's seats are also equipped with separate shoulder harnesses; separate shoulder harnesses are also available for the rear seat positions. Integrated seat belt/shoulder harnesses with inertia

reels can be furnished for the pilot's and front passenger's seat positions if desired.

## **SEAT BELTS**

The seat belts used with the pilot's and front passenger's seats, and the child's seat (if installed), are attached to fittings on the floorboard. The buckle half is inboard of each seat and the link half is outboard of each seat. The belts for the rear seat are attached to the seat frame, with the link halves on the left and right sides of the seat bottom, and the buckles at the center of the seat bottom.

To use the seat belts for the front seats, position the seat as desired, and then lengthen the link half of the belt as needed by grasping the sides of the link and pulling against the belt. Insert and lock the belt link into the buckle. Tighten the belt to a snug fit. Seat belts for the rear seats, and the child's seat, are used in the same manner as the belts for the front seats. To release the seat belts, grasp the top of the buckle opposite the link and pull upward.

## **SHOULDER HARNESES**

Each front seat shoulder harness is attached to a rear doorpost above the window line and is stowed behind a stowage sheath above the cabin door. To stow the harness, fold it and place it behind the sheath. When rear seat shoulder harnesses are furnished, they are attached adjacent to the lower corners of the aft side windows. Each rear seat harness is stowed behind a stowage sheath above an aft side window. No harness is available for the child's seat.

To use a front or rear seat shoulder harness, fasten and adjust the seat belt first. Lengthen the harness as required by pulling on the connecting link on the end of the harness and the narrow release strap. Snap the connecting link firmly onto the retaining stud on the seat belt link half. Then adjust to length. A properly adjusted harness will permit the occupant to lean forward enough to sit completely erect, but prevent excessive forward movement and contact with objects during sudden deceleration. Also, the pilot will want the freedom to reach all controls easily.

Removing the shoulder harness is accomplished by pulling upward on the narrow release strap, and removing the harness connecting link from the stud on the seat belt link. In an emergency, the shoulder harness may be removed by releasing the seat belt first and allowing the harness, still attached to the link half of the seat belt, to drop to the side of the seat.

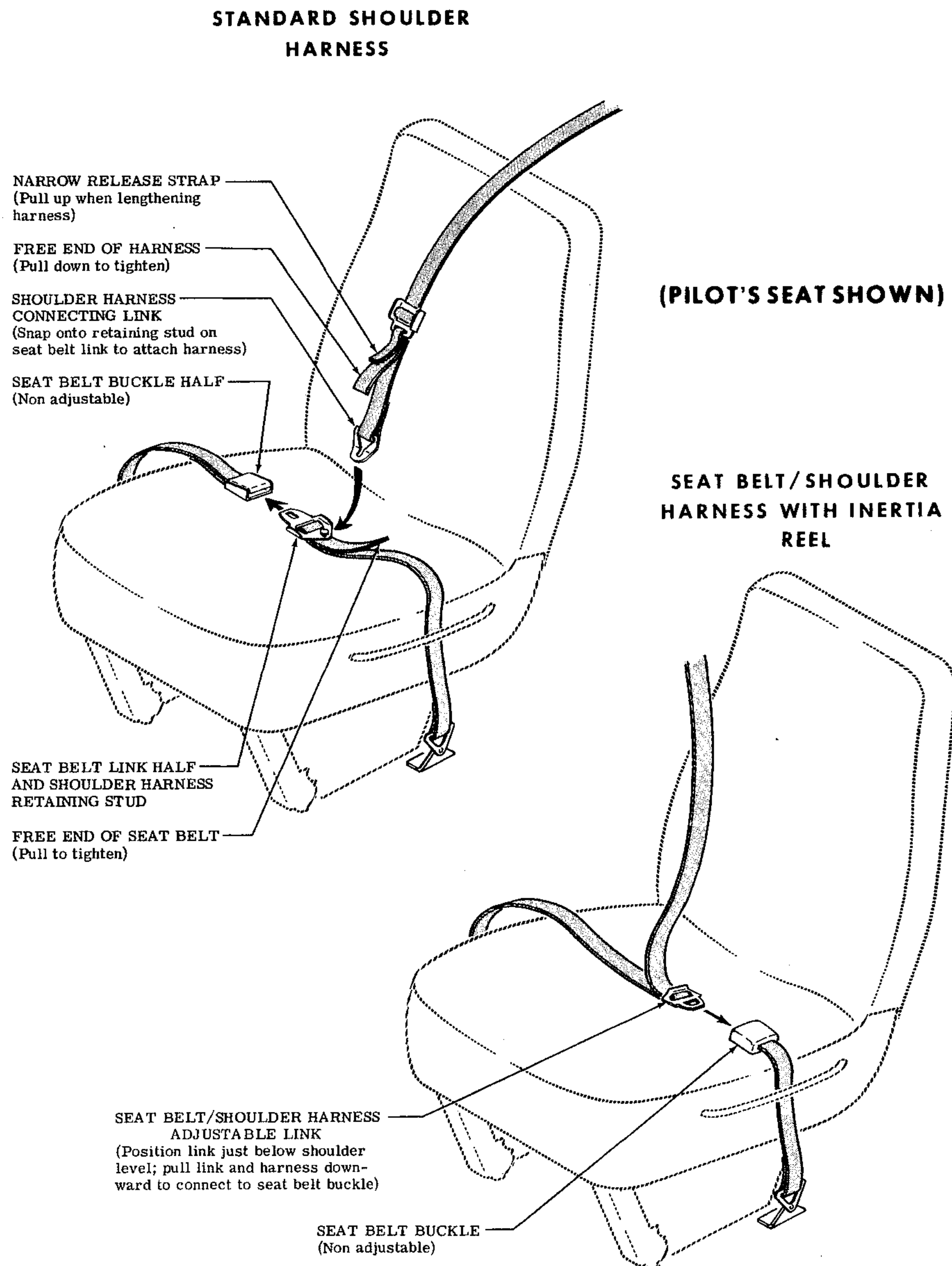

Figure 7-4. Seat Belts and Shoulder Harnesses

## **INTEGRATED SEAT BELT/SHOULDER HARNESSSES WITH INERTIA REELS**

Integrated seat belt/shoulder harnesses with inertia reels are available for the pilot and front seat passenger. The seat belt/shoulder harnesses extend from inertia reels located in the cabin top structure, through slots in the overhead console marked PILOT and COPILOT, to attach points inboard of the two front seats. A separate seat belt half and buckle is located outboard of the seats. Inertia reels allow complete freedom of body movement. However, in the event of a sudden deceleration, they will lock automatically to protect the occupants.

To use the seat belt/shoulder harness, position the adjustable metal link on the harness at about shoulder level, pull the link and harness downward, and insert the link in the seat belt buckle. Adjust belt tension across the lap by pulling upward on the shoulder harness. Removal is accomplished by releasing the seat belt buckle, which will allow the inertia reel to pull the harness inboard of the seat.

## **ENTRANCE DOORS AND CABIN WINDOWS**

Entry to, and exit from the airplane is accomplished through either of two entry doors, one on each side of the cabin at the front seat positions (refer to Section 6 for cabin and cabin door dimensions). The doors incorporate a recessed exterior door handle, a conventional interior door handle, a key-operated door lock (left door only), a door stop mechanism, and an openable window in the left door. An openable right door window is also available.

To open the doors from outside the airplane, utilize the recessed door handle near the aft edge of each door. Depress the forward end of the handle to rotate it out of its recess, and then pull outboard. To close or open the doors from inside the airplane, use the combination door handle and arm rest. The inside door handle has three positions and a placard at its base which reads OPEN, CLOSE, and LOCK. The handle is spring-loaded to the CLOSE (up) position. When the door has been pulled shut and latched, lock it by rotating the door handle forward to the LOCK position (flush with the arm rest). When the handle is rotated to the LOCK position, an over-center action will hold it in that position. Both cabin doors should be locked prior to flight, and should not be opened intentionally during flight.

### **NOTE**

Accidental opening of a cabin door in flight due to improper closing does not constitute a need to land the

airplane. The best procedure is to set up the airplane in a trimmed condition at approximately 80 KIAS, open a window, momentarily shove the door outward slightly, and forcefully close and lock the door.

Exit from the airplane is accomplished by rotating the door handle from the LOCK position, past the CLOSE position, aft to the OPEN position and pushing the door open. To lock the airplane, lock the right cabin door with the inside handle, close the left cabin door, and using the ignition key, lock the door.

The left cabin door is equipped with an openable window which is held in the closed position by a detent equipped latch on the lower edge of the window frame. To open the window, rotate the latch upward. The window is equipped with a spring-loaded retaining arm which will help rotate the window outward and hold it there. An openable window is also available for the right door, and functions in the same manner as the left window. If required, either window may be opened at any speed up to 182 KIAS. The cabin top windows (if installed), rear side windows, and rear window are of the fixed type and cannot be opened.

## CONTROL LOCKS

A control lock is provided to lock the ailerons and elevator control surfaces in a neutral position and prevent damage to these systems by wind buffeting while the airplane is parked. The lock consists of a shaped steel rod with a red metal flag attached to it. The flag is labeled CONTROL LOCK, REMOVE BEFORE STARTING ENGINE. To install the control lock, align the hole in the top of the pilot's control wheel shaft with the hole in the top of the shaft collar on the instrument panel and insert the rod into the aligned holes. Proper installation of the lock will place the red flag over the ignition switch. In areas where high or gusty winds occur, a control surface lock should be installed over the vertical stabilizer and rudder. The control lock and any other type of locking device should be removed prior to starting the engine.

## ENGINE

The airplane is powered by a horizontally-opposed, six-cylinder, overhead-valve, air-cooled, carbureted engine with a wet sump oil system. The engine is a Lycoming Model O-540-J3C5D and is rated at 235 horsepower at 2400 RPM. Major accessories include a starter, belt-driven alternator, and propeller governor on the front of the engine and dual magnetos encased in a single drive housing, fuel pump, vacuum pump, and full-flow



oil filter on the rear of the engine.

## ENGINE CONTROLS

Engine manifold pressure is controlled by a throttle located on the lower center portion of the instrument panel. The throttle operates in a conventional manner; in the full forward position, the throttle is open, and in the full aft position, it is closed. A friction lock, which is a round knurled disk, is located at the base of the throttle and is operated by rotating the lock clockwise to increase friction or counterclockwise to decrease it.

The mixture control, mounted near the propeller control, is a red knob with raised points around the circumference and is equipped with a lock button in the end of the knob. The rich position is full forward, and full aft is the idle cut-off position. For small adjustments, the control may be moved forward by rotating the knob clockwise, and aft by rotating the knob counterclockwise. For rapid or large adjustments, the knob may be moved forward or aft by depressing the lock button in the end of the control, and then positioning the control as desired.

## ENGINE INSTRUMENTS

Engine operation is monitored by the following instruments: oil pressure gage, oil temperature gage, cylinder head temperature gage, tachometer, manifold pressure gage and fuel pressure gage. An economy mixture (EGT) indicator and carburetor air temperature gage are also available.

The oil pressure gage, located on the right side of the instrument panel, is operated by oil pressure. A direct pressure oil line from the engine delivers oil at engine operating pressure to the oil pressure gage. Gage markings indicate that minimum idling pressure is 25 PSI (red line), the normal operating range is 60 to 90 PSI (green arc), and maximum pressure is 100 PSI (red line).

Oil temperature is indicated by a gage adjacent to the oil pressure gage. The gage is a Bourdon-type instrument connected by a capillary tube to a temperature bulb in the engine. Oil temperature limitations are the normal operating range (green arc) which is 38°C (100°F) to 118°C (245°F), and the maximum (red line) which is 118°C (245°F).

The cylinder head temperature gage, under the left fuel quantity indicator, is operated by an electrical-resistance type temperature sensor on the engine which receives power from the airplane electrical system. Temperature limitations are the normal operating range (green arc) which is 93°C (200°F) to 260°C (500°F) and the maximum (red line) which is 260°C (500°F).

The engine-driven mechanical tachometer is located on the lower right side of the instrument panel. The instrument is calibrated in increments of 100 RPM and indicates both engine and propeller speed. An hour meter below the center of the tachometer dial records elapsed engine time in hours and tenths. Instrument markings include a normal operating range (green arc) of 2100 to 2400 RPM, and a maximum (red line) of 2400 RPM.

The manifold pressure gage is located on the right side of the instrument panel above the tachometer. The gage is direct reading and indicates induction air manifold pressure in inches of mercury. It has a normal operating range (green arc) of 15 to 23 inches of mercury.

The fuel pressure gage, located below the flight instruments, and slightly to the left of the control column, indicates fuel pressure to the carburetor. Gage markings indicate that minimum pressure is 0.5 PSI (red line), normal operating range is 0.5 to 8 PSI (green arc), and maximum pressure is 8 PSI (red line).

An economy mixture (EGT) indicator is available for the airplane and is located on the right side of the instrument panel. A thermocouple probe in the left exhaust stack assembly measures exhaust gas temperature and transmits it to the indicator. The indicator serves as a visual aid to the pilot in adjusting the mixture during climb or cruise as described in Section 4. Exhaust gas temperature varies with fuel-to-air ratio, power, and RPM. However, the difference between the peak EGT and the EGT at the desired mixture setting is essentially constant and this provides a useful leaning aid. The indicator is equipped with a manually positioned reference pointer which is especially useful for leaning during climb.

A carburetor air temperature gage may be installed on the left side of the instrument panel to help detect carburetor icing conditions. The gage is marked in 5° increments from -30°C to +30°C, and has a yellow arc between -15°C and +5°C which indicates the temperature range most conducive to icing in the carburetor. A placard on the lower half of the gage face reads **KEEP NEEDLE OUT OF YELLOW ARC DURING POSSIBLE CARBURETOR ICING CONDITIONS.**

## **NEW ENGINE BREAK-IN AND OPERATION**

The engine underwent a run-in at the factory and is ready for the full range of use. It is, however, suggested that cruising be accomplished at 65% to 75% power until a total of 50 hours has accumulated or oil consumption has stabilized. This will ensure proper seating of the rings.

The airplane is delivered from the factory with corrosion preventive oil in the engine. If, during the first 25 hours, oil must be added, use only

aviation grade straight mineral oil conforming to Specification No. MIL-L-6082.

## **ENGINE OIL SYSTEM**

Oil for engine lubrication and propeller governor operation is supplied from a sump on the bottom of the engine. The capacity of the sump is 8 quarts (one additional quart is contained in the engine oil filter). Oil is drawn from the sump through a filter screen on the end of a pickup tube to the engine-driven oil pump. Oil from the pump passes through an oil pressure screen, full flow oil filter, a pressure relief valve at the rear of the right oil gallery, and a thermostatically controlled remote oil cooler. Oil from the remote cooler is then circulated to the left gallery and propeller governor. The engine parts are then lubricated by oil from the galleries. After lubricating the engine, the oil returns to the sump by gravity. The filter adapter in the full flow oil filter is equipped with a bypass valve which will cause lubricating oil to bypass the filter in the event the filter becomes plugged, or the oil temperature is extremely cold.

An oil dipstick is located at the rear of the engine on the right side, and an oil filler tube is on top of the crankcase near the front of the engine. The dipstick and oil filler are accessible through doors on the engine cowling. The engine should not be operated on less than five quarts of oil. To minimize loss of oil through the breather, fill to seven quarts for normal flights of less than three hours. For extended flight, fill to eight quarts (dipstick indication only). For engine oil grade and specifications, refer to Section 8 of this handbook.

An oil quick-drain valve is available to replace the drain plug on the bottom of the oil sump, and provides quicker, cleaner draining of the engine oil. To drain the oil with this valve installed, slip a hose over the end of the valve and push upward on the end of the valve until it snaps into the open position. Spring clips will hold the valve open. After draining, use a suitable tool to snap the valve into the extended (closed) position and remove the drain hose.

## **IGNITION-STARTER SYSTEM**

Engine ignition is provided by two engine-driven magnetos encased in a single drive housing, and two spark plugs in each cylinder. The right magneto fires the lower left and upper right spark plugs, and the left magneto fires the lower right and upper left spark plugs. Normal operation is conducted with both magnetos due to the more complete burning of the fuel-air mixture with dual ignition.

Ignition and starter operation is controlled by a rotary type switch

located on the left switch and control panel. The switch is labeled clockwise, OFF, R, L, BOTH, and START. The engine should be operated on both magnetos (BOTH position) except for magneto checks. The R and L positions are for checking purposes and emergency use only. When the switch is rotated to the spring-loaded START position (with the master switch in the ON position), the starter contactor is energized and the starter will crank the engine. When the switch is released, it will automatically return to the BOTH position.

### **AIR INDUCTION SYSTEM**

The engine air induction system receives ram air through an intake scoop in the upper left hand engine cowling. The intake scoop is covered by an air filter which removes dust and other foreign matter from the induction air. Airflow passing through the filter enters an airbox. After passing through the airbox, induction air enters the inlet in the carburetor which is below the engine, and is then ducted to the engine cylinders through intake manifold tubes. In the event carburetor ice is encountered or the intake filter becomes blocked, alternate heated air can be obtained from a shroud around the left muffler through a duct to a valve, in the airbox, operated by the carburetor heat control on the instrument panel. Heated air from the muffler shroud is obtained from unfiltered air inside the cowling. Use of full carburetor heat at full throttle will result in a loss of approximately one inch of manifold pressure.

### **EXHAUST SYSTEM**

Exhaust gas from each cylinder passes through riser assemblies to a muffler and tailpipe on each side of the engine. Shrouds are constructed around the outside of the mufflers to form heating chambers. The left muffler supplies heat to the carburetor, and the right muffler supplies heat to the cabin.

### **CARBURETOR AND PRIMING SYSTEM**

The engine is equipped with a horizontally-mounted, up-draft, float-type, fixed jet carburetor mounted below the engine adjacent to the firewall. The carburetor is equipped with an enclosed accelerator pump, an idle cut-off mechanism, and a manual mixture control. Fuel is delivered from the fuel system to the carburetor by gravity flow and the engine-driven fuel pump. In the carburetor, fuel is atomized, proportionally mixed with intake air, and delivered to the cylinders through intake manifold tubes. The proportion of atomized fuel to air is controlled, within limits, by the mixture control located on the lower center portion of the instrument panel.

For easy starting in cold weather, the engine is equipped with a

manual primer. The primer is actually a small pump which draws fuel from the fuel strainer when the plunger is pulled out, and injects it into the engine intake ports when the plunger is pushed back in. The plunger is equipped with a lock and, after being pushed full in, must be rotated either left or right until the knob cannot be pulled out.

## COOLING SYSTEM

Ram air for engine cooling enters through two intake openings in the front of the engine cowling. The cooling air is directed through the remote oil cooler (behind the left intake opening), and around the cylinders and other areas of the engine by baffling, and is then exhausted through cowl flaps on the lower aft edge of the cowling. The cowl flaps are mechanically operated from the cabin by means of a cowl flap lever on the right side of the control pedestal. The pedestal is labeled OPEN, COWL FLAPS, CLOSED. Before starting the engine, and throughout takeoff and high power operation, the cowl flap lever should be placed in the OPEN position for maximum cooling. This is accomplished by moving the lever to the right to clear a detent, then moving the lever up to the OPEN position. Anytime the lever is repositioned, it must first be moved to the right. While in cruise flight, cowl flaps should be adjusted to keep the cylinder head temperature at approximately two-thirds of the normal operating range (green arc). During extended let-downs, the cowl flaps should be completely closed by pushing the cowl flap lever down to the CLOSED position.

A winterization kit is available and consists of two clips and two baffles which attach to the air intakes in the cowling nose cap, and a placard to be installed on the instrument panel. This equipment should be installed for operations in temperatures consistently below  $-7^{\circ}\text{C}$  ( $20^{\circ}\text{F}$ ).

## PROPELLER

The airplane has an all-metal, two-bladed, constant-speed, governor-regulated propeller. A setting introduced into the governor with the propeller control establishes the propeller speed, and thus the engine speed to be maintained. The governor then controls flow of engine oil, boosted to high pressure by the governing pump, to or from a piston in the propeller hub. Oil pressure acting on the piston twists the blades toward high pitch (low RPM). When oil pressure to the piston in the propeller hub is relieved, centrifugal force, assisted by an internal spring, twists the blades toward low pitch (high RPM).

A control knob on the lower center portion of the instrument panel is used to set the propeller and control engine RPM as desired for various

flight conditions. The knob is labeled PROPELLER, PUSH INCR RPM. When the control knob is pushed in, blade pitch will decrease, giving a higher RPM. When the control knob is pulled out, the blade pitch increases, thereby decreasing RPM. The propeller control knob is equipped with a vernier feature which allows slow or fine RPM adjustments by rotating the knob clockwise to increase RPM, and counterclockwise to decrease it. To make rapid or large adjustments, depress the button on the end of the control knob and reposition the control as desired.

## FUEL SYSTEM

The airplane may be equipped with either a standard fuel system or long range system (see figure 7-6). Both systems consist of two vented fuel tanks (one in each wing), a four-position selector valve, fuel strainer, manual primer, engine-driven fuel pump, auxiliary fuel pump, and carburetor. Refer to figure 7-5 for fuel quantity data for both systems.

Fuel flows by gravity from the two wing tanks to a four-position selector valve, labeled BOTH, RIGHT, LEFT, and OFF. With the selector valve in either the BOTH, RIGHT, or LEFT position, fuel flows through a strainer to the engine-driven fuel pump, and from the pump to the carburetor. When the auxiliary fuel pump is operating, it draws fuel from a tee located between the strainer and the engine-driven fuel pump, and delivers it to the carburetor. From the carburetor, mixed fuel and air flows to the cylinders through intake manifold tubes. The manual primer draws its fuel from the fuel strainer and injects it into the engine intake ports.

Fuel system venting is essential to system operation. Complete blockage of the venting system will result in collapsing of the bladder

FUEL QUANTITY DATA (U. S. GALLONS)			
TANKS	TOTAL USABLE FUEL ALL FLIGHT CONDITIONS	TOTAL UNUSABLE FUEL	TOTAL FUEL VOLUME
STANDARD (30.5 Gal. Each)	56	5	61
LONG RANGE (40 Gal. Each)	75	5	80

Figure 7-5. Fuel Quantity Data

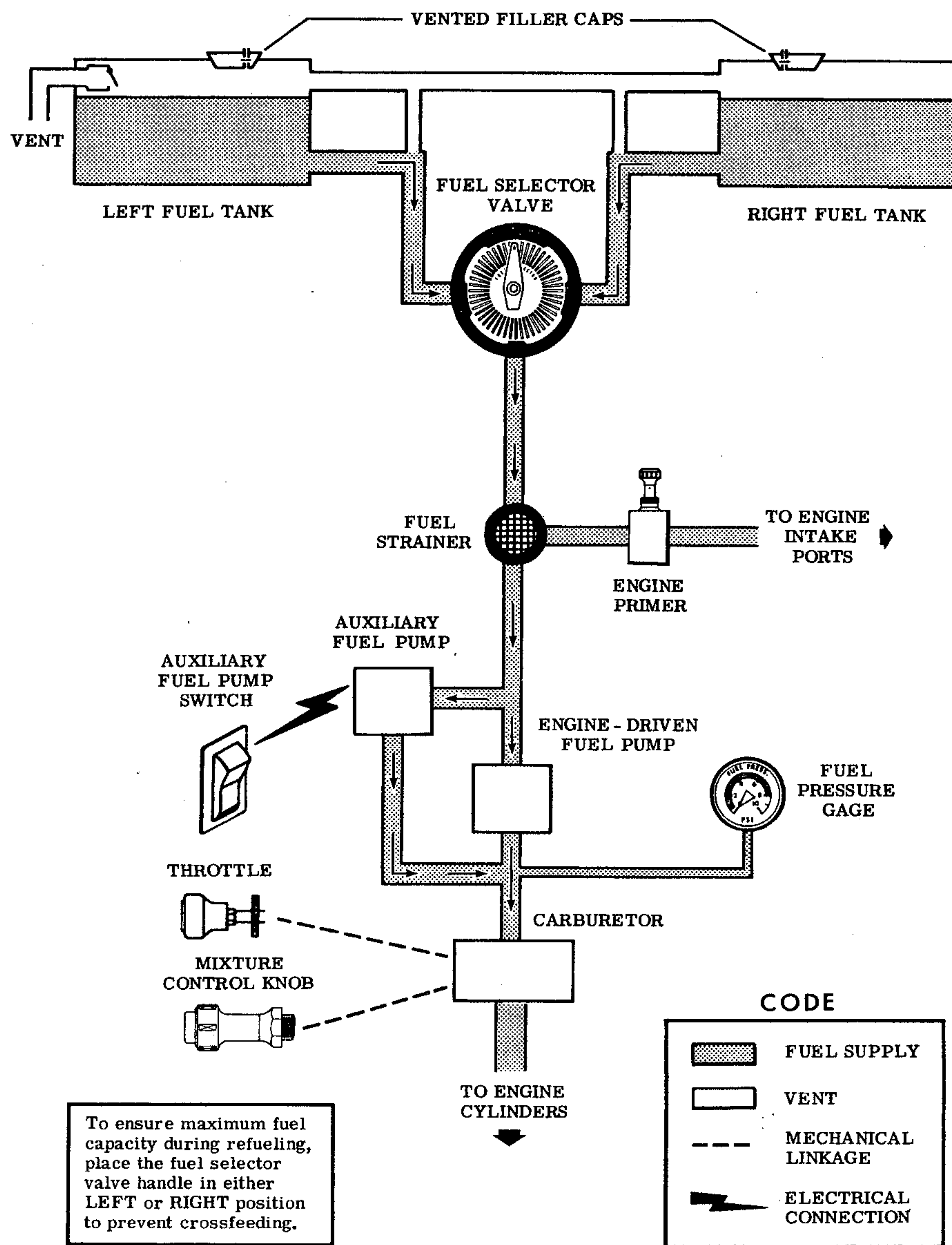

Figure 7-6. Fuel System (Standard and Long Range)

cells, a decreasing fuel flow and eventual engine stoppage. Venting of the right tank is accomplished by an interconnecting line from the left tank. The left fuel tank is vented overboard through a vent line which is equipped with a check valve, and protrudes from the bottom surface of the left wing near the wing strut attach point. The fuel filler caps are equipped with vacuum operated vents which open, allowing air into the tanks, should the fuel tank vent line become blocked.

Fuel quantity is measured by two float-type fuel quantity transmitters (one in each tank) and indicated by two electrically-operated fuel quantity indicators on the right side of the instrument panel. An empty tank is indicated by a red line and the letter E. When an indicator shows an empty tank, approximately 2.5 gallons remain in a standard tank or long range tank as unusable fuel. The indicators cannot be relied upon for accurate readings during skids, slips, or unusual attitudes. If both indicator pointers should rapidly move to a zero reading, check the cylinder head temperature gage for operation. If this gage is not indicating, an electrical malfunction has occurred.

The auxiliary fuel pump switch is located on the left side of the switch and control panel and is a rocker-type switch. It is labeled AUX FUEL PUMP. When the pump is operating, it will maintain fuel pressure to the carburetor. It should be used whenever the indicated fuel pressure falls below 0.5 PSI, but is not required when gravity flow and/or the engine-driven fuel pump can maintain indicated pressures above 0.5 PSI.

The fuel selector valve should be in the BOTH position for takeoff, climb, landing, and maneuvers that involve prolonged slips or skids. Operation from either LEFT or RIGHT tank is reserved for cruising flight.

#### NOTE

When the fuel selector valve handle is in the BOTH position in cruising flight, unequal fuel flow from each tank may occur if the wings are not maintained exactly level. Resulting wing heaviness can be alleviated gradually by turning the selector valve handle to the tank in the "heavy" wing.

#### NOTE

It is not practical to measure the time required to consume all of the fuel in one tank, and, after switching to the opposite tank, expect an equal duration from the remaining fuel. The airspace in both fuel tanks is interconnected by a vent line and, therefore, some sloshing of fuel between tanks can be expected when the tanks are nearly full and



the wings are not level.

The fuel system is equipped with drain valves to provide a means for the examination of fuel in the system for contamination and grade. The system should be examined before the first flight of every day and after each refueling, by using the sampler cup provided to drain fuel from the wing tank sumps, and by utilizing the fuel strainer drain under an access panel on the left side of the engine cowling. The fuel tanks should be filled after each flight to prevent condensation.

## HYDRAULIC SYSTEM

Hydraulic power (see figure 7-7) is supplied by an electrically-driven hydraulic power pack located behind the firewall between the pilot's and copilot's rudder pedals. The power pack's only function is to supply hydraulic power for operation of the retractable landing gear. This is accomplished by applying hydraulic pressure to actuator cylinders which extend or retract the gear. The hydraulic system normally operates at 1000 PSI to 1500 PSI, and is protected by relief valves which prevent high pressure damage to the pump and other components in the system. The electrical portion of the power pack is protected by a 30-amp push-pull type circuit breaker switch, labeled GEAR PUMP, on the left switch and control panel.

The hydraulic power pack is turned on by a pressure switch on the power pack when the landing gear lever is placed in either the GEAR UP or GEAR DOWN position. When the lever is placed in the GEAR UP or GEAR DOWN position, it mechanically rotates a selector valve which applies hydraulic pressure in the direction selected. As soon as the landing gear reaches the selected position, a series of electrical switches will illuminate one of two indicator lights on the instrument panel to show gear position and completion of the cycle. After indicator light illumination, hydraulic pressure will continue to build until the power pack pressure switch turns the power pack off.

The hydraulic system includes an emergency hand pump to permit manual extension of the landing gear in the event of hydraulic power pack failure. The hand pump is located on the cabin floor between the front seats.

During normal operations, the landing gear should require from 5 to 7 seconds to fully extend or retract. For malfunctions of the hydraulic and landing gear systems, refer to Section 3 of this handbook.

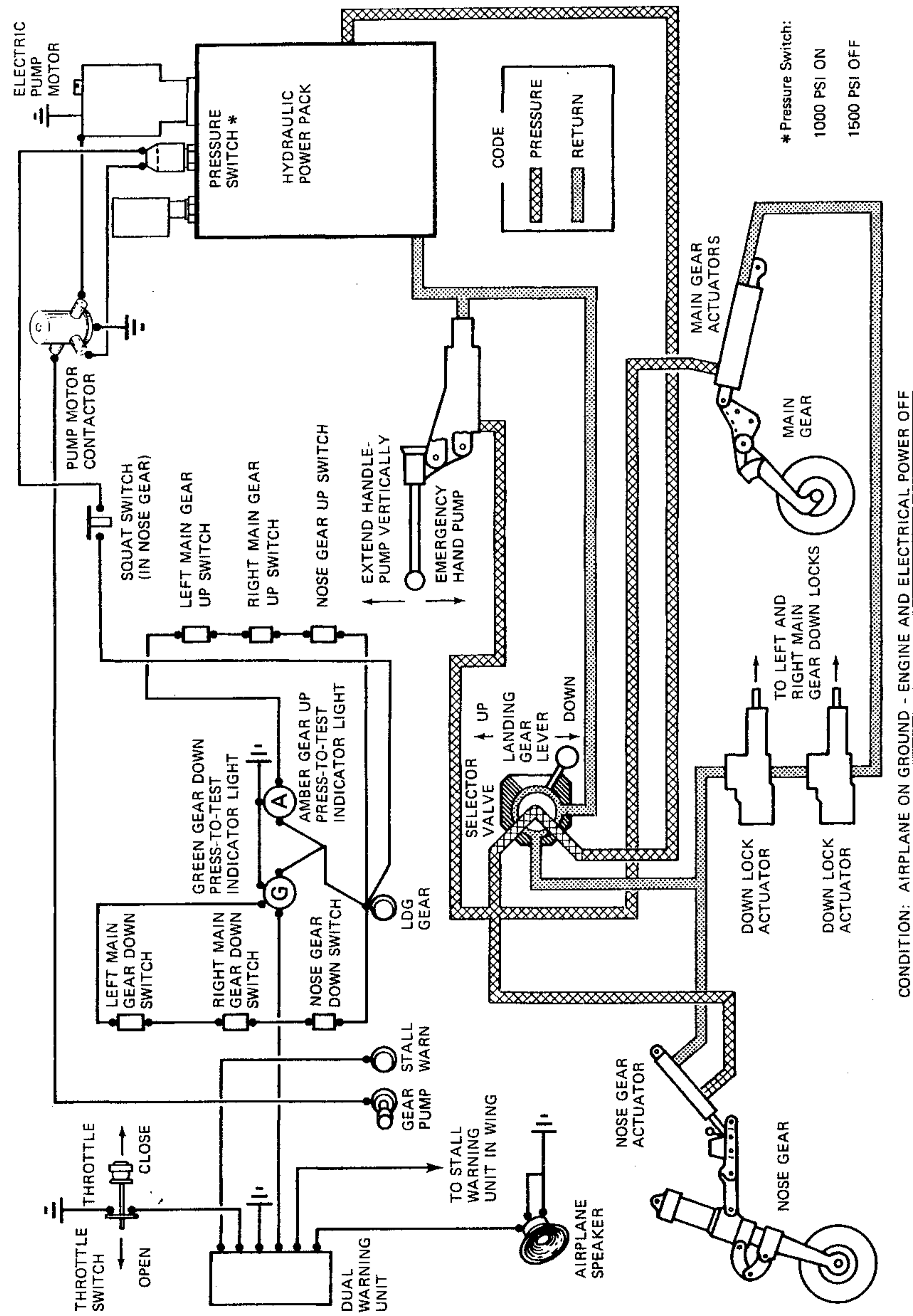

Figure 7-7. Hydraulic System

## **BRAKE SYSTEM**

The airplane has a single-disc, hydraulically-actuated brake on each main landing gear wheel. Each brake is connected, by a hydraulic line, to a master cylinder attached to each of the pilot's rudder pedals. The brakes are operated by applying pressure to the top of either the left (pilot's) or right (copilot's) set of rudder pedals, which are interconnected. When the airplane is parked, both main wheel brakes may be set by utilizing the parking brake which is operated by a handle under the left side of the instrument panel. To apply the parking brake, set the brakes with the rudder pedals, pull the handle aft, and rotate it 90° down.

For maximum brake life, keep the brake system properly maintained, and minimize brake usage during taxi operations and landings.

Some of the symptoms of impending brake failure are: gradual decrease in braking action after brake application, noisy or dragging brakes, soft or spongy pedals, and excessive travel and weak braking action. If any of these symptoms appear, the brake system is in need of immediate attention. If, during taxi or landing roll, braking action decreases, let up on the pedals and then re-apply the brakes with heavy pressure. If the brakes become spongy or pedal travel increases, pumping the pedals should build braking pressure. If one brake becomes weak or fails, use the other brake sparingly while using opposite rudder, as required, to offset the good brake.

## **ELECTRICAL SYSTEM**

Electrical energy (see figure 7-8) is supplied by a 28-volt, direct-current system powered by an engine-driven, 60-amp alternator. A 24-volt, 14-amp hour battery (or 17-amp hour battery, if installed) is located on the right forward portion of the firewall. Power is supplied to most general electrical and all avionics circuits through the primary bus bar and the avionics bus bar, which are interconnected by an avionics power switch. The primary bus is on anytime the master switch is turned on, and is not affected by starter or external power usage. Both bus bars are on anytime the master and avionics power switches are turned on.

### **CAUTION**

Prior to turning the master switch on or off, starting the engine, or applying an external power source, the avionics power switch, labeled AVN PWR, should be turned off to prevent any harmful transient voltage from damaging the avionics equipment.

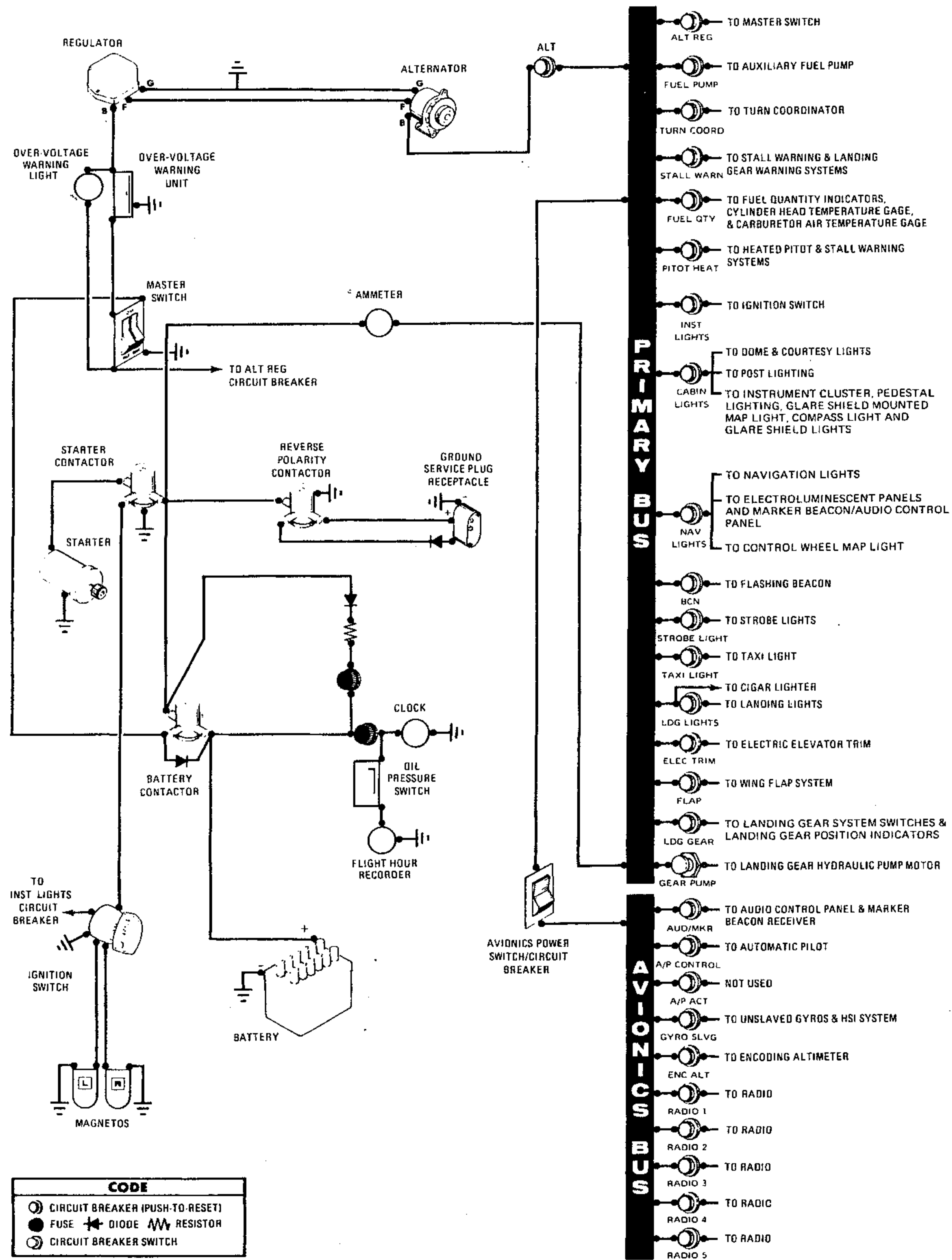

Figure 7-8. Electrical System

## **MASTER SWITCH**

The master switch is a split-rocker type switch labeled MASTER, and is ON in the up position and off in the down position. The right half of the switch, labeled BAT, controls all electrical power to the airplane. The left half, labeled ALT, controls the alternator.

Normally, both sides of the master switch should be used simultaneously; however, the BAT side of the switch could be turned ON separately to check equipment while on the ground. To check or use avionics equipment or radios while on the ground, the avionics power switch must be turned ON. The ALT side of the switch, when placed in the off position, removes the alternator from the electrical system. With this switch in the off position, the entire electrical load is placed on the battery. Continued operation with the alternator switch in the off position will reduce battery power low enough to open the battery contactor, remove power from the alternator field, and prevent alternator restart.

## **AVIONICS POWER SWITCH**

Electrical power from the airplane primary bus to the avionics bus (see figure 7-8) is controlled by a single rocker-type circuit breaker-switch labeled AVN PWR. The switch is located on the right side of the avionics circuit breaker panel and is ON in the up position and OFF in the down position. With the switch in the OFF position, no electrical power will be applied to the avionics equipment, regardless of the position of the master switch or the individual equipment switches. The avionics power switch also functions as a circuit breaker. If an electrical malfunction should occur and cause the circuit breaker to open, electrical power to the avionics equipment will be interrupted and the switch breaker will automatically move to the OFF position. If this occurs, allow the circuit breaker approximately two minutes to cool before placing the breaker in the ON position again. If the circuit breaker opens again, do not reset it. The avionics power switch should be placed in the OFF position prior to turning the master switch on or off, starting the engine, or applying an external power source, and may be utilized in place of the individual avionics equipment switches.

## **AMMETER**

The ammeter indicates the flow of current, in amperes, from the alternator to the battery or from the battery to the airplane electrical system. When the engine is operating and the master switch is turned on, the ammeter indicates the charging rate applied to the battery. In the event the alternator is not functioning or the electrical load exceeds the output of the alternator, the ammeter indicates the battery discharge rate.

## **OVER-VOLTAGE SENSOR AND WARNING LIGHT**

The airplane is equipped with an automatic over-voltage protection system consisting of an over-voltage sensor behind the instrument panel and a red warning light, labeled HIGH VOLTAGE, near the manifold pressure gage.

In the event an over-voltage condition occurs, the over-voltage sensor automatically removes alternator field current and shuts down the alternator. The warning light will then turn on, indicating to the pilot that the alternator is not operating and the battery is supplying all electrical power.

The over-voltage sensor may be reset by turning off the avionics power switch and then turning the master switch off and back on again. If the warning light does not illuminate, normal alternator charging has resumed; however, if the light does illuminate again, a malfunction has occurred, and the flight should be terminated as soon as practical. In either case, the avionics power switch may be turned on again if required.

The warning light may be tested by momentarily turning off the ALT portion of the master switch and leaving the BAT portion turned on.

## **CIRCUIT BREAKERS AND FUSES**

Most of the electrical circuits in the airplane are protected by "push-to-reset" circuit breakers mounted on the lower left side of the switch and control panel. The landing gear circuit is protected by a push-pull type circuit breaker on the lower left side of the switch and control panel. In addition to the individual circuit breakers, a single-rocker type circuit breaker-switch, labeled AVN PWR on the avionics panel, located between the left forward doorpost and the switch and control panel, also protects the avionics systems. The cigar lighter is protected by a manually-reset type circuit breaker on the back of the lighter, and a fuse behind the instrument panel. The control wheel map light (if installed) is protected by the NAV LIGHTS circuit breaker and a fuse behind the instrument panel. Electrical circuits which are not protected by circuit breakers are the battery contactor closing (external power) circuit, clock circuit, and flight hour recorder circuit. These circuits are protected by fuses mounted adjacent to the battery.

## **GROUND SERVICE PLUG RECEPTACLE**

A ground service plug receptacle may be installed to permit the use of an external power source (generator type or battery cart) for cold weather starting and during lengthy maintenance work on the airplane electrical

system. The receptacle is located behind a door on the left side of the fuselage near the aft edge of the cowling.

#### NOTE

If no avionics equipment is to be used or worked on, the avionics power switch should be turned off. If maintenance is required on the avionics equipment, it is advisable to utilize a battery cart external power source to prevent damage to the avionics equipment by transient voltage. Do not crank or start the engine with the avionics power switch turned on.

Just before connecting an external power source (generator type or battery cart), the avionics power switch should be turned off, and the master switch turned on.

The ground service plug receptacle circuit incorporates a polarity reversal protection. Power from the external power source will flow only if the ground service plug is correctly connected to the airplane. If the plug is accidentally connected backwards, no power will flow to the electrical system, thereby preventing any damage to electrical equipment.

The battery and external power circuits have been designed to completely eliminate the need to "jumper" across the battery contactor to close it for charging a completely "dead" battery. A special fused circuit in the external power system supplies the needed "jumper" across the contacts so that with a "dead" battery and an external power source applied, turning on the master switch will close the battery contactor.

## LIGHTING SYSTEMS

### EXTERIOR LIGHTING

Conventional navigation lights are located on the wing tips and tail stinger, and dual landing lights are installed in the cowl nose cap. Additional lighting is available and includes a strobe light on each wing tip, a flashing beacon on top of the vertical stabilizer, and two courtesy lights, one under each wing, just outboard of the cabin door. The courtesy lights are operated by a switch located on the left rear door post. All exterior lights, except the courtesy lights, are controlled by rocker type switches on the left switch and control panel. The switches are ON in the up position and off in the down position.

The flashing beacon should not be used when flying through clouds or

overcast; the flashing light reflected from water droplets or particles in the atmosphere, particularly at night, can produce vertigo and loss of orientation.

The high intensity strobe lights will enhance anti-collision protection. However, the lights should be turned off when taxiing in the vicinity of other airplanes, or during night flight through clouds, fog or haze.

## INTERIOR LIGHTING

Instrument and control panel lighting is provided by flood and integral lighting, with electroluminescent and post lighting also available. Rheostats and control knobs, located on the left switch and control panel, control the intensity of all lighting. The following paragraphs describe the various lighting systems and their controls.

Switches and controls on the switch and control panel are lighted by electroluminescent panels which do not require light bulbs for illumination. To utilize this lighting, turn on the NAV light switch and adjust light intensity with the small (inner) control knob of the concentric control knobs labeled EL PANEL, ENG-RADIO.

Instrument panel flood lighting consists of four red flood lights on the underside of the antiglare shield, and two red flood lights in the forward part of the overhead console. The lights are utilized by adjusting light intensity with the large (outer) control knob of the concentric control knobs labeled POST, FLOOD. Flood lighting may be used in combination with post lighting by adjusting post light intensity with the small (inner) control knob.

The instrument panel may be equipped with post lights which are mounted at the edge of each instrument or control and provide direct lighting. To operate the post lights, adjust light intensity with the small (inner) control knob of the concentric control knobs labeled POST, FLOOD. To combine post and flood lighting, adjust flood light intensity with the large (outer) control knob.

The engine instrument cluster, radio equipment, and magnetic compass have integral lighting and operate independently of post or flood lighting. The light intensity of instrument cluster, magnetic compass, and radio equipment lighting is controlled by the large (outer) control knob of the concentric control knobs labeled EL PANEL, ENG-RADIO. If the airplane is equipped with avionics incorporating incandescent digital readouts, the ENG-RADIO (large outer) control knob controls the light intensity of the digital readouts. For daylight operation, the control knob should be rotated full counterclockwise to produce maximum light inten-



sity for the digital readouts only. Clockwise rotation of the control knob will provide normal variable light intensity for nighttime operation.

The control pedestal has two integral lights. Pedestal light intensity is controlled by the large (outer) control knob of the concentric control knobs labeled EL PANEL, ENG-RADIO.

Map lighting is provided by overhead console map lights and an antiglare shield mounted map light. The airplane may also be equipped with a control wheel map light. The overhead console map lights operate in conjunction with instrument panel flood lighting and consist of two openings just aft of the red instrument panel flood lights. The map light openings have sliding covers controlled by small round knobs which uncover the openings when moved toward each other. The covers should be kept closed unless the map lights are required. A map light and toggle switch, mounted in front of the pilot on the underside of the antiglare shield, is used for illuminating approach plates or other charts when using a control wheel mounted approach plate holder. The switch is labeled MAP LIGHT, ON, OFF and light intensity is controlled by the FLOOD (large outer) control knob. The pilot's control wheel map light (if installed) illuminates the lower portion of the cabin in front of the pilot, and is used for checking maps and other flight data during night operation. The light is utilized by turning on the NAV light switch, and adjusting light intensity with the rheostat control knob on the bottom of the control wheel.

The airplane is equipped with a dome light aft of the overhead console. The light is operated by a slide-type switch, aft of the light lens, which turns the light on when moved to the right.

The most probable cause of a light failure is a burned out bulb; however, in the event any of the lighting systems fail to illuminate when turned on, check the appropriate circuit breaker. If the circuit breaker has opened (white button popped out), and there is no obvious indication of a short circuit (smoke or odor), turn off the light switch of the affected lights, reset the breaker, and turn the switch on again. If the breaker opens again, do not reset it.

## **CABIN HEATING, VENTILATING AND DEFROSTING SYSTEM**

The temperature and volume of airflow into the cabin can be regulated to any degree desired by manipulation of the push-pull CABIN HEAT and CABIN AIR control knobs (see figure 7-9). Both control knobs are the double button type with locks to permit intermediate settings.

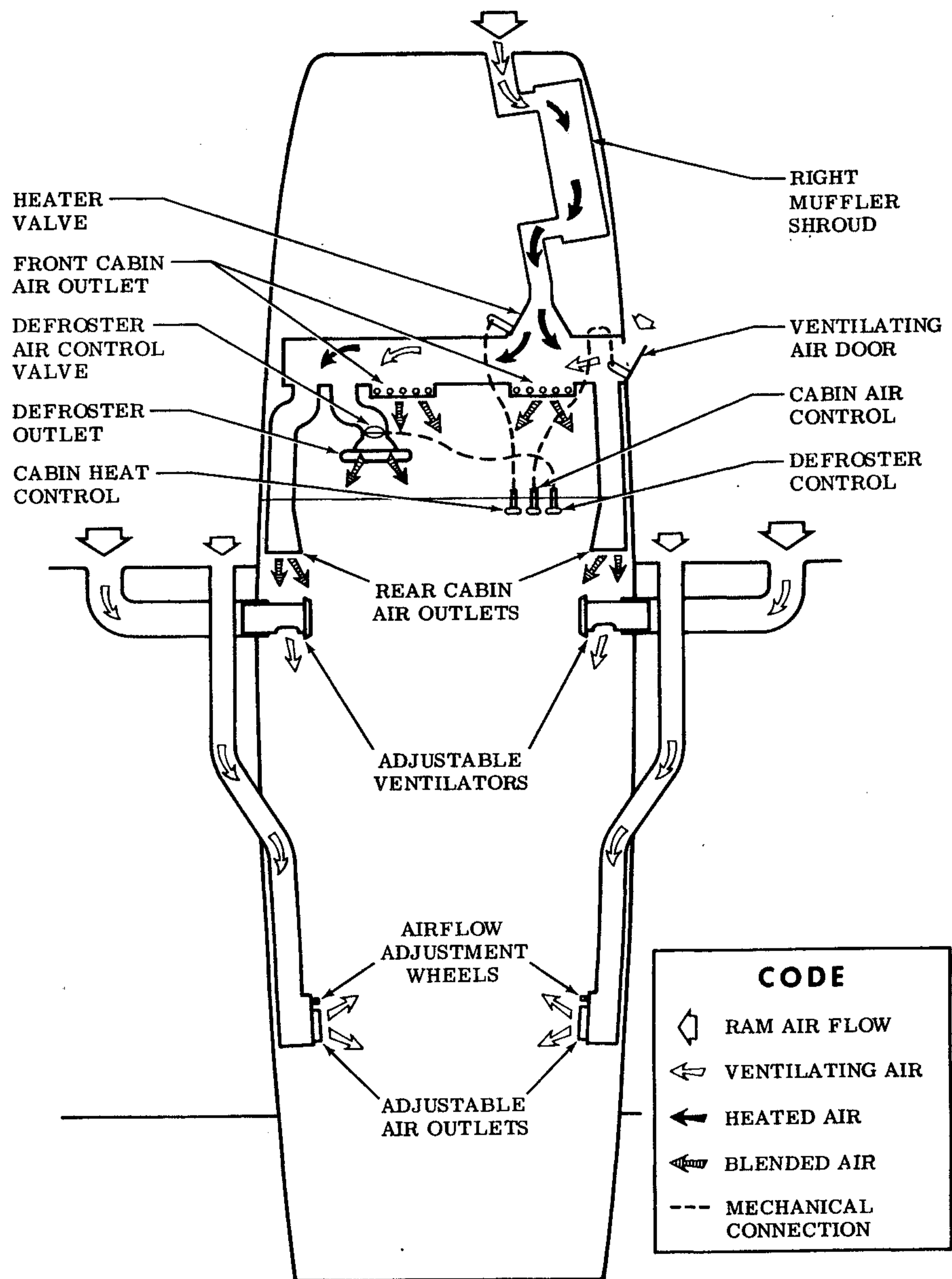

Figure 7-9. Cabin Heating, Ventilating, and Defrosting System

### NOTE

For improved partial heating on mild days, pull out the CABIN AIR knob slightly when the CABIN HEAT knob is out. This action increases the airflow through the system, increasing efficiency, and blends cool outside air with the exhaust manifold heated air, thus eliminating the possibility of overheating the system ducting.

Front cabin heat and ventilating air is supplied by outlet holes spaced across a cabin manifold just forward of the pilot's and copilot's feet. Rear cabin heat and air is supplied by two ducts from the manifold, one extending down each side of the cabin to an outlet at the front door post at floor level. Windshield defrost air is also supplied by a duct leading from the cabin manifold to an outlet on top of the antiglare shield. Defrost air flow is controlled by a rotary type knob labeled DEFROST.

For cabin ventilation, pull the CABIN AIR knob out, with the CABIN HEAT knob pushed full in. To raise the air temperature, pull the CABIN HEAT knob out until the desired temperature is attained. Additional heat is available by pulling the knob out farther; maximum heat is available with the CABIN HEAT knob pulled out and the CABIN AIR knob pushed full in.

Separate adjustable ventilators supply additional ventilation air to the cabin. One near each upper corner of the windshield supplies air for the pilot and copilot, and two ventilators are available for the rear cabin area to supply air to the rear seat passengers. Each rear ventilator outlet can be adjusted in any desired direction by moving the entire outlet to direct the airflow up or down, and by moving a tab protruding from the center of the outlet left or right to obtain left or right airflow. Ventilation airflow may be closed off completely, or partially closed according to the amount of airflow desired, by rotating an adjustment wheel adjacent to the outlet.

## PITOT-STATIC SYSTEM AND INSTRUMENTS

The pitot-static system supplies ram air pressure to the airspeed indicator and static pressure to the airspeed indicator, rate-of-climb indicator and altimeter. The system is composed of either an unheated or heated pitot tube mounted on the lower surface of the left wing, two external static ports on the left and right sides of the forward fuselage, and the associated plumbing necessary to connect the instruments to the sources.

The heated pitot system consists of a heating element in the pitot tube,

a rocker-type switch labeled PITOT HEAT, a 10-amp circuit breaker on the switch and control panel, and associated wiring. When the pitot heat switch is turned on, the element in the pitot tube is heated electrically to maintain proper operation in possible icing conditions. Pitot heat should be used only as required.

A static pressure alternate source valve may be installed adjacent to the parking brake, and can be used if the external static source is malfunctioning. This valve supplies static pressure from inside the cabin instead of the external static ports.

If erroneous instrument readings are suspected due to water or ice in the pressure line going to the standard external static pressure source, the alternate static source valve should be pulled on.

Pressures within the cabin will vary with open cabin ventilators and windows. Refer to Sections 3 and 5 for the effect of varying cabin pressures on airspeed and altimeter readings.

## AIRSPPEED INDICATOR

The airspeed indicator is calibrated in knots and miles per hour. Limitation and range markings include the white arc (37 to 95 knots), green arc (42 to 143 knots), yellow arc (143 to 182 knots), and a red line (182 knots).

If a true airspeed indicator is installed, it is equipped with a rotatable ring which works in conjunction with the airspeed indicator dial in a manner similar to the operation of a flight computer. To operate the indicator, first rotate the ring until **pressure** altitude is aligned with outside air temperature in degrees Fahrenheit. Pressure altitude should not be confused with indicated altitude. To obtain pressure altitude, momentarily set the barometric scale on the altimeter to 29.92 and read pressure altitude on the altimeter. Be sure to return the altimeter barometric scale to the original barometric setting after pressure altitude has been obtained. Having set the ring to correct for altitude and temperature, read the true airspeed shown on the rotatable ring by the indicator pointer. For best accuracy, the indicated airspeed should be corrected to calibrated airspeed by referring to the Airspeed Calibration chart in Section 5. Knowing the calibrated airspeed, read true airspeed on the ring opposite the calibrated airspeed.

## RATE-OF-CLIMB INDICATOR

The rate-of-climb indicator depicts airplane rate of climb or descent in feet per minute. The pointer is actuated by atmospheric pressure changes resulting from changes of altitude as supplied by the static source.

## **ALTIMETER**

Airplane altitude is depicted by a barometric type altimeter. A knob near the lower left portion of the indicator provides adjustment of the instrument's barometric scale to the current altimeter setting.

## **VACUUM SYSTEM AND INSTRUMENTS**

An engine-driven vacuum system (see figure 7-10) provides the suction necessary to operate the attitude indicator and directional indicator. The system consists of a vacuum pump mounted on the engine, a vacuum relief valve and vacuum system air filter on the aft side of the firewall below the instrument panel, and instruments (including a suction gage) on the left side of the instrument panel.

### **ATTITUDE INDICATOR**

The attitude indicator gives a visual indication of flight attitude. Bank attitude is presented by a pointer at the top of the indicator relative to the bank scale which has index marks at 10°, 20°, 30°, 60°, and 90° either side of the center mark. Pitch and roll attitudes are presented by a miniature airplane in relation to the horizon bar. A knob at the bottom of the instrument is provided for in-flight adjustment of the miniature airplane to the horizon bar for a more accurate flight attitude indication.

### **DIRECTIONAL INDICATOR**

A directional indicator displays airplane heading on a compass card in relation to a fixed simulated airplane image and index. The directional indicator will precess slightly over a period of time. Therefore, the compass card should be set in accordance with the magnetic compass just prior to takeoff, and occasionally re-adjusted on extended flights. A knob on the lower left edge of the instrument is used to adjust the compass card to correct for any precession.

### **SUCTION GAGE**

The suction gage, located below the flight instruments, is calibrated in inches of mercury and indicates suction available for operation of the attitude and directional indicators. The desired suction range is 4.5 to 5.4 inches of mercury. A suction reading below this range may indicate a system malfunction or improper adjustment, and in this case, the indicators should not be considered reliable.

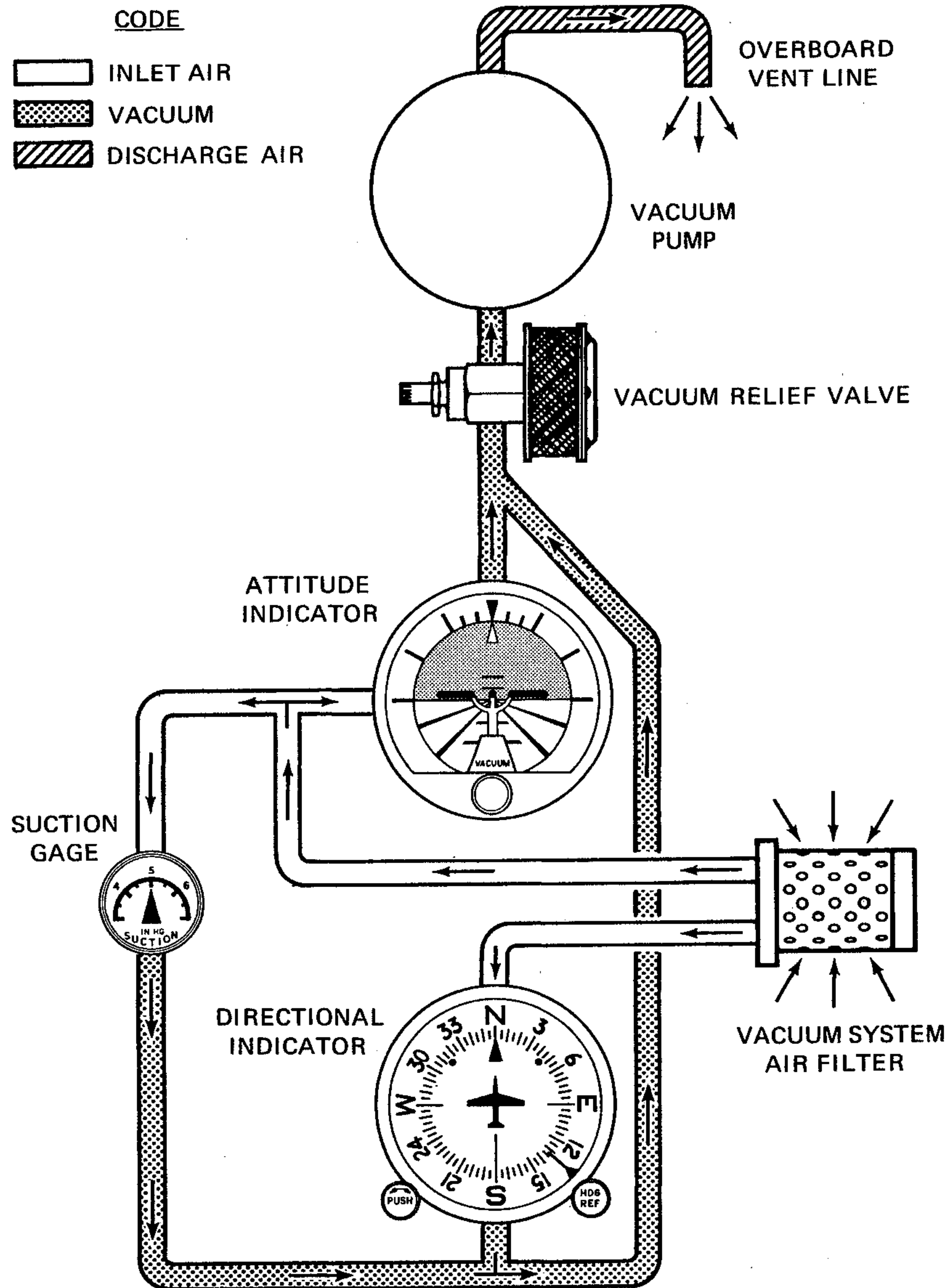

Figure 7-10. Vacuum System

## **STALL WARNING SYSTEM**

The airplane is equipped with a vane-type stall warning unit, in the leading edge of the left wing, which is electrically connected to a stall warning horn under the map compartment. A 5-amp circuit breaker protects the stall warning system. The vane in the wing senses the change in airflow over the wing, and operates the warning horn at airspeeds between 5 and 10 knots above the stall in all configurations.

If the airplane has a heated stall warning system, the vane and sensor unit in the wing leading edge is equipped with a heating element. The heated part of the system is operated by the PITOT HEAT switch, and is protected by the PITOT HEAT circuit breaker.

The stall warning system should be checked during the pre-flight inspection by momentarily turning on the master switch and actuating the vane in the wing. The system is operational if the warning horn sounds as the vane is pushed upward.

## **AVIONICS SUPPORT EQUIPMENT**

The airplane may, at the owner's discretion, be equipped with various types of avionics support equipment such as an audio control panel, microphone-headset, and static dischargers. The following paragraphs discuss these items.

### **AUDIO CONTROL PANEL**

Operation of radio equipment is covered in Section 9 of this handbook. When one or more radios is installed, a transmitter/audio switching system is provided (see figure 7-11). The operation of this switching system is described in the following paragraphs.

#### **TRANSMITTER SELECTOR SWITCH**

A rotary type transmitter selector switch, labeled XMTR SEL, is provided to connect the microphone to the transmitter the pilot desires to use. To select a transmitter, rotate the switch to the number corresponding to that transmitter. The numbers 1, 2 and 3 above the switch correspond to the top, second and third transceivers in the avionics stack.

The audio amplifier in the NAV/COM radio is required for speaker and transmitter operation. The amplifier is automatically selected, along with

**AUTOMATIC AUDIO SELECTION**

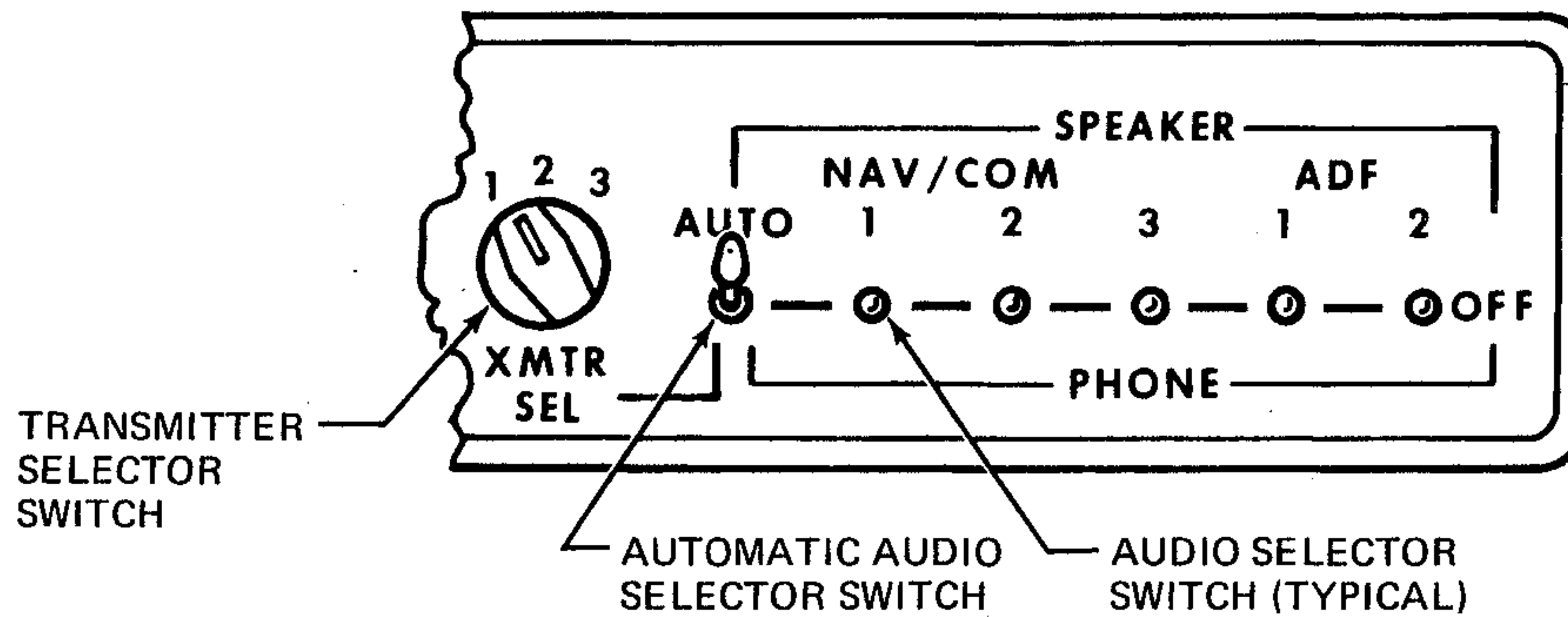

As illustrated, the number 1 transmitter is selected, the AUTO selector switch is in the SPEAKER position, and the NAV/COM 1, 2 and 3 and ADF 1 and 2 audio selector switches are in the OFF position. With the switches set as shown, the pilot will transmit on the number 1 transmitter and hear the number 1 NAV/COM receiver through the airplane speaker.

**INDIVIDUAL AUDIO SELECTION**

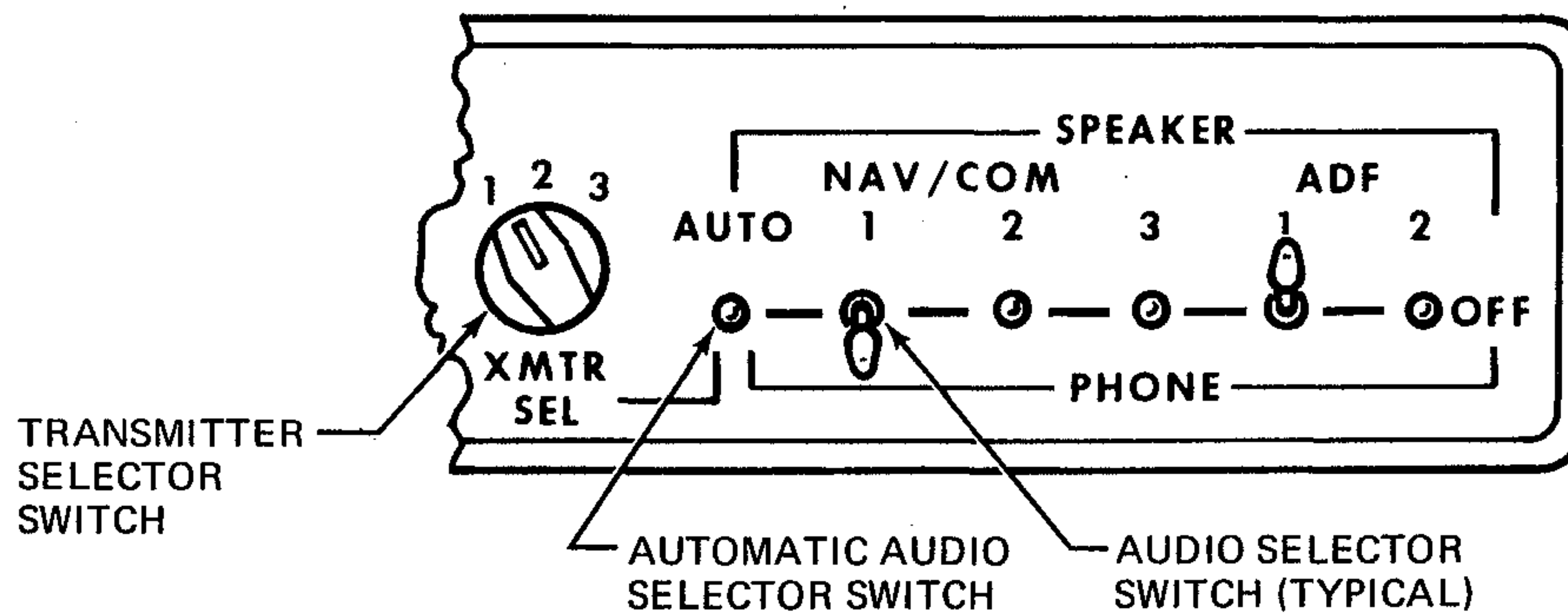

As illustrated, the number 1 transmitter is selected, the AUTO selector switch is in the OFF position, the number 1 NAV/COM receiver is in the PHONE position, and the number 1 ADF is in the SPEAKER position. With the switches set as shown, the pilot will transmit on the number 1 transmitter and hear the number 1 NAV/COM receiver on a headset; while the passengers are listening to the ADF audio through the airplane speaker. If another audio selector switch is placed in either the PHONE or SPEAKER position, it will be heard simultaneously with either the number 1 NAV/COM or number 1 ADF respectively.

Figure 7-11. Audio Control Panel



the transmitter, by the transmitter selector switch. As an example, if the number 1 transmitter is selected, the audio amplifier in the associated NAV/COM receiver is also selected, and functions as the amplifier for ALL speaker audio. In the event the audio amplifier in use fails, as evidenced by loss of all speaker audio and transmitting capability of the selected transmitter, select another transmitter. This should re-establish speaker audio and transmitter operation. Since headset audio is not affected by audio amplifier operation, the pilot should be aware that, while utilizing a headset, the only indication of audio amplifier failure is loss of the selected transmitter. This can be verified by switching to the speaker function.

### **AUTOMATIC AUDIO SELECTOR SWITCH**

A toggle switch, labeled AUTO, can be used to automatically match the appropriate NAV/COM receiver audio to the transmitter being selected. To utilize this automatic feature, leave all NAV/COM receiver switches in the OFF (center) position, and place the AUTO selector switch in either the SPEAKER or PHONE position, as desired. Once the AUTO selector switch is positioned, the pilot may then select any transmitter and its associated NAV/COM receiver audio simultaneously with the transmitter selector switch. If automatic audio selection is not desired, the AUTO selector switch should be placed in the OFF (center) position.

#### **NOTE**

Cessna radios are equipped with sidetone capability (monitoring of the operator's own voice transmission). Sidetone will be heard on either the airplane speaker or a headset as selected with the AUTO selector switch. Sidetone may be eliminated by placing the AUTO selector switch in the OFF position, and utilizing the individual radio selector switches.

### **AUDIO SELECTOR SWITCHES**

The audio selector switches, labeled NAV/COM 1, 2 and 3 and ADF 1 and 2, allow the pilot to initially pre-tune all NAV/COM and ADF receivers, and then individually select and listen to any receiver or combination of receivers. To listen to a specific receiver, first check that the AUTO selector switch is in the OFF (center) position, then place the audio selector switch corresponding to that receiver in either the SPEAKER (up) or PHONE (down) position. To turn off the audio of the selected receiver, place that switch in the OFF (center) position. If desired, the audio selector switches can be positioned to permit the pilot to listen to one receiver on a headset while the passengers listen to another receiver on the airplane speaker.

The ADF 1 and 2 switches may be used anytime ADF audio is desired. If

the pilot wants only ADF audio, for station identification or other reasons, the AUTO selector switch (if in use) and all other audio selector switches should be in the OFF position. If simultaneous ADF and NAV/COM audio is acceptable to the pilot, no change in the existing switch positions is required. Place the ADF 1 or 2 switch in either the SPEAKER or PHONE position and adjust radio volume as desired.

#### NOTE

If the NAV/COM audio selector switch corresponding to the selected transmitter is in the PHONE position with the AUTO selector switch in the SPEAKER position, all audio selector switches placed in the PHONE position will automatically be connected to both the airplane speaker and any headsets in use.

## MICROPHONE-HEADSET

The microphone-headset combination consists of the microphone and headset combined in a single unit and a microphone keying switch located on the left side of the pilot's control wheel. The microphone-headset permits the pilot to conduct radio communications without interrupting other control operations to handle a hand-held microphone. Also, passengers need not listen to all communications. The microphone and headset jacks are located near the lower left corner of the instrument panel.

## STATIC DISCHARGERS

If frequent IFR flights are planned, installation of wick-type static dischargers is recommended to improve radio communications during flight through dust or various forms of precipitation (rain, snow or ice crystals). Under these conditions, the build-up and discharge of static electricity from the trailing edges of the wings, rudder, elevator, propeller tips, and radio antennas can result in loss of usable radio signals on all communications and navigation radio equipment. Usually the ADF is first to be affected and VHF communication equipment is the last to be affected.

Installation of static dischargers reduces interference from precipitation static, but it is possible to encounter severe precipitation static conditions which might cause the loss of radio signals, even with static dischargers installed. Whenever possible, avoid known severe precipitation areas to prevent loss of dependable radio signals. If avoidance is impractical, minimize airspeed and anticipate temporary loss of radio signals while in these areas.

# SECTION 8

## AIRPLANE HANDLING, SERVICE & MAINTENANCE

### TABLE OF CONTENTS

	Page
Introduction . . . . .	8-3
Identification Plate . . . . .	8-3
Owner Follow-Up System . . . . .	8-3
Publications . . . . .	8-3
Airplane File . . . . .	8-4
Airplane Inspection Periods . . . . .	8-5
FAA Required Inspections . . . . .	8-5
Cessna Progressive Care . . . . .	8-6
Cessna Customer Care Program . . . . .	8-6
Pilot Conducted Preventive Maintenance . . . . .	8-7
Alterations or Repairs . . . . .	8-7
Ground Handling . . . . .	8-7
Towing . . . . .	8-7
Parking . . . . .	8-7
Tie-Down . . . . .	8-8
Jacking . . . . .	8-8
Leveling . . . . .	8-9
Flyable Storage . . . . .	8-9
Servicing . . . . .	8-9
Engine Oil . . . . .	8-10
Fuel . . . . .	8-11
Landing Gear . . . . .	8-11
Cleaning and Care . . . . .	8-11
Windshield-Windows . . . . .	8-11
Painted Surfaces . . . . .	8-12
Propeller Care . . . . .	8-13
Landing Gear Care . . . . .	8-13
Engine Care . . . . .	8-13
Interior Care . . . . .	8-13



## INTRODUCTION

This section contains factory-recommended procedures for proper ground handling and routine care and servicing of your Cessna. It also identifies certain inspection and maintenance requirements which must be followed if your airplane is to retain that new-plane performance and dependability. It is wise to follow a planned schedule of lubrication and preventive maintenance based on climatic and flying conditions encountered in your locality.

Keep in touch with your Cessna Dealer and take advantage of his knowledge and experience. He knows your airplane and how to maintain it. He will remind you when lubrications and oil changes are necessary, and about other seasonal and periodic services.

## IDENTIFICATION PLATE

All correspondence regarding your airplane should include the SERIAL NUMBER. The Serial Number, Model Number, Production Certificate Number (PC) and Type Certificate Number (TC) can be found on the Identification Plate, located on the left forward doorpost. Located adjacent to the Identification Plate is a Finish and Trim Plate which contains a code describing the interior color scheme and exterior paint combination of the airplane. The code may be used in conjunction with an applicable Parts Catalog if finish and trim information is needed.

## OWNER FOLLOW-UP SYSTEM

Your Cessna Dealer has an Owner Follow-Up System to notify you when he receives information that applies to your Cessna. In addition, if you wish, you may choose to receive similar notification, in the form of Service Letters, directly from the Cessna Customer Services Department. A subscription form is supplied in your Customer Care Program book for your use, should you choose to request this service. Your Cessna Dealer will be glad to supply you with details concerning these follow-up programs, and stands ready, through his Service Department, to supply you with fast, efficient, low-cost service.

## PUBLICATIONS

Various publications and flight operation aids are furnished in the

airplane when delivered from the factory. These items are listed below.

- CUSTOMER CARE PROGRAM BOOK
- PILOT'S OPERATING HANDBOOK/SUPPLEMENTS FOR YOUR AIRPLANE AVIONICS AND AUTOPILOT
- PILOT'S CHECKLISTS
- POWER COMPUTER
- SALES AND SERVICE DEALER DIRECTORY

The following additional publications, plus many other supplies that are applicable to your airplane, are available from your Cessna Dealer.

- SERVICE MANUALS AND PARTS CATALOGS FOR YOUR AIRPLANE ENGINE AND ACCESSORIES AVIONICS AND AUTOPILOT

Your Cessna Dealer has a Customer Care Supplies Catalog covering all available items, many of which he keeps on hand. He will be happy to place an order for any item which is not in stock.

## **AIRPLANE FILE**

There are miscellaneous data, information and licenses that are a part of the airplane file. The following is a checklist for that file. In addition, a periodic check should be made of the latest Federal Aviation Regulations to ensure that all data requirements are met.

A. To be displayed in the airplane at all times:

1. Aircraft Airworthiness Certificate (FAA Form 8100-2).
2. Aircraft Registration Certificate (FAA Form 8050-3).
3. Aircraft Radio Station License, if transmitter installed (FCC Form 556).

B. To be carried in the airplane at all times:

1. Weight and Balance, and associated papers (latest copy of the Repair and Alteration Form, FAA Form 337, if applicable).
2. Equipment List.

C. To be made available upon request:

1. Airplane Log Book.
2. Engine Log Book.

Most of the items listed are required by the United States Federal Aviation Regulations. Since the Regulations of other nations may require other documents and data, owners of airplanes not registered in the United States should check with their own aviation officials to determine their individual requirements.

Cessna recommends that these items, plus the Pilot's Operating Handbook, Pilot's Checklists, Power Computer, Customer Care Program book and Customer Care Card, be carried in the airplane at all times.

## AIRPLANE INSPECTION PERIODS

### FAA REQUIRED INSPECTIONS

As required by Federal Aviation Regulations, all civil aircraft of U.S. registry must undergo a complete inspection (annual) each twelve calendar months. In addition to the required ANNUAL inspection, aircraft operated commercially (for hire) must have a complete inspection every 100 hours of operation.

The FAA may require other inspections by the issuance of airworthiness directives applicable to the airplane, engine, propeller and components. It is the responsibility of the owner/operator to ensure compliance with all applicable airworthiness directives and, when the inspections are repetitive, to take appropriate steps to prevent inadvertent noncompliance.

In lieu of the 100 HOUR and ANNUAL inspection requirements, an airplane may be inspected in accordance with a progressive inspection schedule, which allows the work load to be divided into smaller operations that can be accomplished in shorter time periods.

The CESSNA PROGRESSIVE CARE PROGRAM has been developed to provide a modern progressive inspection schedule that satisfies the complete airplane inspection requirements of both the 100 HOUR and ANNUAL inspections as applicable to Cessna airplanes. The program assists the owner in his responsibility to comply with all FAA inspection requirements, while ensuring timely replacement of life-limited parts and adherence to factory-recommended inspection intervals and maintenance procedures.

## **CESSNA PROGRESSIVE CARE**

The Cessna Progressive Care Program has been designed to help you realize maximum utilization of your airplane at a minimum cost and downtime. Under this program, your airplane is inspected and maintained in four operations at 50-hour intervals during a 200-hour period. The operations are recycled each 200 hours and are recorded in a specially provided Aircraft Inspection Log as each operation is conducted.

The Cessna Aircraft Company recommends Progressive Care for airplanes that are being flown 200 hours or more per year, and the 100-hour inspection for all other airplanes. The procedures for the Progressive Care Program and the 100-hour inspection have been carefully worked out by the factory and are followed by the Cessna Dealer Organization. The complete familiarity of Cessna Dealers with Cessna equipment and factory-approved procedures provides the highest level of service possible at lower cost to Cessna owners.

Regardless of the inspection method selected by the owner, he should keep in mind that FAR Part 43 and FAR Part 91 establishes the requirement that properly certified agencies or personnel accomplish all required FAA inspections and most of the manufacturer recommended inspections.

## **CESSNA CUSTOMER CARE PROGRAM**

Specific benefits and provisions of the CESSNA WARRANTY plus other important benefits for you are contained in your CUSTOMER CARE PROGRAM book supplied with your airplane. You will want to thoroughly review your Customer Care Program book and keep it in your airplane at all times.

Coupons attached to the Program book entitle you to an initial inspection and either a Progressive Care Operation No.1 or the first 100-hour inspection within the first 6 months of ownership at no charge to you. If you take delivery from your Dealer, the initial inspection will have been performed before delivery of the airplane to you. If you pick up your airplane at the factory, plan to take it to your Dealer reasonably soon after you take delivery, so the initial inspection may be performed allowing the Dealer to make any minor adjustments which may be necessary.

You will also want to return to your Dealer either at 50 hours for your first Progressive Care Operation, or at 100 hours for your first 100-hour inspection depending on which program you choose to establish for your airplane. While these important inspections will be performed for you by any Cessna Dealer, in most cases you will prefer to have the Dealer from whom you purchased the airplane accomplish this work.



## PILOT CONDUCTED PREVENTIVE MAINTENANCE

A certified pilot who owns or operates an airplane not used as an air carrier is authorized by FAR Part 43 to perform limited maintenance on his airplane. Refer to FAR Part 43 for a list of the specific maintenance operations which are allowed.

### NOTE

Pilots operating airplanes of other than U.S. registry should refer to the regulations of the country of certification for information on preventive maintenance that may be performed by pilots.

A Service Manual should be obtained prior to performing any preventive maintenance to ensure that proper procedures are followed. Your Cessna Dealer should be contacted for further information or for required maintenance which must be accomplished by appropriately licensed personnel.

## ALTERATIONS OR REPAIRS

It is essential that the FAA be contacted prior to any alterations on the airplane to ensure that airworthiness of the airplane is not violated. Alterations or repairs to the airplane must be accomplished by licensed personnel.

## GROUND HANDLING

### TOWING

The airplane is most easily and safely maneuvered by hand with the tow-bar attached to the nose wheel. When towing with a vehicle, do not exceed the nose gear turning angle of 30° either side of center, or damage to the gear will result. If the airplane is towed or pushed over a rough surface during hangaring, watch that the normal cushioning action of the nose strut does not cause excessive vertical movement of the tail and the resulting contact with low hangar doors or structure. A flat nose tire or deflated strut will also increase tail height.

### PARKING

When parking the airplane, head into the wind and set the parking

brakes. Do not set the parking brakes during cold weather when accumulated moisture may freeze the brakes, or when the brakes are overheated. Close the cowl flaps, install the control wheel lock and chock the wheels. In severe weather and high wind conditions, tie the airplane down as outlined in the following paragraph.

### **TIE-DOWN**

Proper tie-down procedure is the best precaution against damage to the parked airplane by gusty or strong winds. To tie-down the airplane securely, proceed as follows:

1. Set the parking brake and install the control wheel lock.
2. Install a surface control lock over the fin and rudder.
3. Tie sufficiently strong ropes or chains (700 pounds tensile strength) to the wing and tail tie-down fittings and secure each rope to a ramp tie-down.
4. Tie a rope (no chains or cables) to the nose gear torque link and secure to a ramp tie-down.
5. Install a pitot tube cover.

### **JACKING**

When a requirement exists to jack one or both main gear, the entire airplane should be jacked by using the wing jack points. Refer to the Service Manual for specific procedures and equipment required.

If nose gear maintenance is required, the nose wheel may be raised off the ground by pressing down on a tailcone bulkhead, just forward of the horizontal stabilizer, and allowing the tail to rest on the tail tie-down ring.

#### **NOTE**

Do not apply pressure on the elevator or outboard stabilizer surfaces. When pushing on the tailcone, always apply pressure at the bulkhead to avoid buckling the skin.

To assist in raising and holding the nose wheel off the ground, weight down the tail by placing sand-bags, or suitable weights, on each side of the horizontal stabilizer, next to the fuselage. If ground anchors are available, the tail should be securely tied down.

#### **NOTE**

Ensure that the nose will be held off the ground under all conditions by means of suitable stands or supports under weight supporting bulkheads near the nose of the airplane.

## LEVELING

Longitudinal leveling of the airplane is accomplished by placing a level on the leveling screws located on the left side of the tailcone. Deflate the nose tire and/or lower or raise the nose strut to properly center the bubble in the level. Corresponding points on both upper door sills may be used to level the airplane laterally.

## FLYABLE STORAGE

Airplanes placed in non-operational storage for a maximum of 30 days or those which receive only intermittent operational use for the first 25 hours are considered in flyable storage status. Every seventh day during these periods, the propeller should be rotated by hand through five revolutions. This action "limbers" the oil and prevents any accumulation of corrosion on engine cylinder walls.

### **WARNING**

For maximum safety, check that the ignition switch is OFF, the throttle is closed, the mixture control is in the idle cut-off position, and the airplane is secured before rotating the propeller by hand. Do not stand within the arc of the propeller blades while turning the propeller.

After 30 days, the airplane should be flown for 30 minutes or a ground runup should be made just long enough to produce an oil temperature within the lower green arc range. Excessive ground runup should be avoided.

Engine runup also helps to eliminate excessive accumulations of water in the fuel system and other air spaces in the engine. Keep fuel tanks full to minimize condensation in the tanks. Keep the battery fully charged to prevent the electrolyte from freezing in cold weather. If the airplane is to be stored temporarily, or indefinitely, refer to the Service Manual for proper storage procedures.

## SERVICING

In addition to the PREFLIGHT INSPECTION covered in Section 4, COMPLETE servicing, inspection, and test requirements for your airplane are detailed in the Service Manual. The Service Manual outlines all items which require attention at 50, 100, and 200 hour intervals plus those items which require servicing, inspection, and/or testing at special intervals.

Since Cessna Dealers conduct all service, inspection, and test procedures in accordance with applicable Service Manuals, it is recommended that you contact your Cessna Dealer concerning these requirements and begin scheduling your airplane for service at the recommended intervals.

Cessna Progressive Care ensures that these requirements are accomplished at the required intervals to comply with the 100-hour or ANNUAL inspection as previously covered.

Depending on various flight operations, your local Government Aviation Agency may require additional service, inspections, or tests. For these regulatory requirements, owners should check with local aviation officials where the airplane is being operated.

For quick and ready reference, quantities, materials, and specifications for frequently used service items are as follows:

## **ENGINE OIL**

### **GRADE AND VISCOSITY FOR TEMPERATURE RANGE --**

The airplane was delivered from the factory with a corrosion preventive aircraft engine oil. This oil should be drained after the first 25 hours of operation, and the following oils used as specified for the average ambient air temperature in the operating area.

**MIL-L-6082 Aviation Grade Straight Mineral Oil:** Use to replenish supply during the first 25 hours and at the first 25-hour oil change. Continue to use until a total of 50 hours has accumulated or oil consumption has stabilized.

SAE 50 above 16°C (60°F).

SAE 40 between -1°C (30°F) and 32°C (90°F).

SAE 30 between -18°C (0°F) and 21°C (70°F).

SAE 20 below -12°C (10°F).

**MIL-L-22851 Ashless Dispersant Oil:** This oil must be used after the first 50 hours or oil consumption has stabilized.

SAE 40 or SAE 50 above 16°C (60°F).

SAE 40 between -1°C (30°F) and 32°C (90°F).

SAE 30 or SAE 40 between -18°C (0°F) and 21°C (70°F).

SAE 30 below -12°C (10°F).

### **CAPACITY OF ENGINE SUMP -- 8 Quarts.**

Do not operate on less than 5 quarts. To minimize loss of oil through breather, fill to 7 quart level for normal flights of less than 3 hours. For extended flight, fill to 8 quarts. These quantities refer to oil dipstick level readings. During oil and oil filter changes, one additional quart is required when the filter is changed.

#### **OIL AND OIL FILTER CHANGE --**

After the first 25 hours of operation, drain engine oil sump and change the filter. Refill sump with straight mineral oil and use until a total of 50 hours has accumulated or oil consumption has stabilized; then change to dispersant oil. Drain the engine oil sump and change the filter each 50 hours thereafter. The oil change interval may be extended to 100-hour intervals, providing the oil filter is changed at 50-hour intervals. Change engine oil at least every 6 months even though less than the recommended hours have accumulated. Reduce intervals for prolonged operation in dusty areas, cold climates, or when short flights and long idle periods result in sludging conditions.

#### **FUEL**

##### **APPROVED FUEL GRADES (AND COLORS) --**

100LL Grade Aviation Fuel (Blue).

100 (Formerly 100/130) Grade Aviation Fuel (Green).

**CAPACITY EACH STANDARD TANK -- 30.5 Gallons.**

**CAPACITY EACH LONG RANGE TANK -- 40.0 Gallons.**

#### **NOTE**

To ensure maximum fuel capacity during refueling, place the fuel selector valve handle in either LEFT or RIGHT position to prevent cross-feeding.

#### **LANDING GEAR**

**NOSE WHEEL TIRE PRESSURE -- 50 PSI on 5.00-5, 6-Ply Rated Tire.**

**MAIN WHEEL TIRE PRESSURE -- 68 PSI on 15 x 6.00-6, 6-Ply Rated Tires.**

**NOSE GEAR SHOCK STRUT --**

Keep filled with MIL-H-5606 hydraulic fluid and inflated with air to 55 PSI with no load on strut.

**HYDRAULIC FLUID RESERVOIR -- Check every 25 hours and service with MIL-H-5606 hydraulic fluid.**

#### **CLEANING AND CARE**

##### **WINDSHIELD-WINDOWS**

The plastic windshield and windows should be cleaned with an aircraft windshield cleaner. Apply the cleaner sparingly with soft cloths, and rub with moderate pressure until all dirt, oil scum and bug stains are removed. Allow the cleaner to dry, then wipe it off with soft flannel cloths.

If a windshield cleaner is not available, the plastic can be cleaned with soft cloths moistened with Stoddard solvent to remove oil and grease.

**NOTE**

**Never use gasoline, benzine, alcohol, acetone, carbon tetrachloride, fire extinguisher or anti-ice fluid, lacquer thinner or glass cleaner to clean the plastic. These materials will attack the plastic and may cause it to craze.**

Follow by **carefully** washing with a mild detergent and plenty of water. Rinse thoroughly, then dry with a clean moist chamois. **Do not rub** the plastic with a dry cloth since this builds up an electrostatic charge which attracts dust. Waxing with a good commercial wax will finish the cleaning job. A thin, even coat of wax, polished out by hand with clean soft flannel cloths, will fill in minor scratches and help prevent further scratching.

**Do not use** a canvas cover on the windshield unless freezing rain or sleet is anticipated since the cover may scratch the plastic surface.

**PAINTED SURFACES**

The painted exterior surfaces of your new Cessna have a durable, long lasting finish and, under normal conditions, require no polishing or buffing. Approximately 15 days are required for the paint to cure completely; in most cases, the curing period will have been completed prior to delivery of the airplane. In the event that polishing or buffing is required within the curing period, it is recommended that the work be done by someone experienced in handling uncured paint. Any Cessna Dealer can accomplish this work.

Generally, the painted surfaces can be kept bright by washing with water and mild soap, followed by a rinse with water and drying with cloths or a chamois. Harsh or abrasive soaps or detergents which cause corrosion or scratches should never be used. Remove stubborn oil and grease with a cloth moistened with Stoddard solvent.

Waxing is unnecessary to keep the painted surfaces bright. However, if desired, the airplane may be waxed with a good automotive wax. A heavier coating of wax on the leading edges of the wings and tail and on the engine nose cap and propeller spinner will help reduce the abrasion encountered in these areas.

When the airplane is parked outside in cold climates and it is necessary to remove ice before flight, care should be taken to protect the painted surfaces during ice removal with chemical liquids. A 50-50 solution of isopropyl alcohol and water will satisfactorily remove ice accumulations

without damaging the paint. A solution with more than 50% alcohol is harmful and should be avoided. While applying the de-icing solution, keep it away from the windshield and cabin windows since the alcohol will attack the plastic and may cause it to craze.

## PROPELLER CARE

Preflight inspection of propeller blades for nicks, and wiping them occasionally with an oily cloth to clean off grass and bug stains will assure long, trouble-free service. Small nicks on the propeller, particularly near the tips and on the leading edges, should be dressed out as soon as possible since these nicks produce stress concentrations, and if ignored, may result in cracks. Never use an alkaline cleaner on the blades; remove grease and dirt with carbon tetrachloride or Stoddard solvent.

## LANDING GEAR CARE

Cessna Dealer's mechanics have been trained in the proper adjustment and rigging procedures on the airplane hydraulic system. To assure trouble-free gear operation, have your Cessna Dealer check the gear regularly and make any necessary adjustments. Only properly trained mechanics should attempt to repair or adjust the landing gear.

## ENGINE CARE

The engine may be cleaned with Stoddard solvent, or equivalent, then dried thoroughly.

### CAUTION

Particular care should be given to electrical equipment before cleaning. Cleaning fluids should not be allowed to enter magnetos, starter, alternator and the like. Protect these components before saturating the engine with solvents. All other openings should also be covered before cleaning the engine assembly. Caustic cleaning solutions should be used cautiously and should always be properly neutralized after their use.

## INTERIOR CARE

To remove dust and loose dirt from the upholstery and carpet, clean the interior regularly with a vacuum cleaner.

Blot up any spilled liquid promptly with cleansing tissue or rags. Don't pat the spot; press the blotting material firmly and hold it for several seconds. Continue blotting until no more liquid is taken up. Scrape off sticky materials with a dull knife, then spot-clean the area.

Oily spots may be cleaned with household spot removers, used sparingly. Before using any solvent, read the instructions on the container and test it on an obscure place on the fabric to be cleaned. Never saturate the fabric with a volatile solvent; it may damage the padding and backing materials.

Soiled upholstery and carpet may be cleaned with foam-type detergent, used according to the manufacturer's instructions. To minimize wetting the fabric, keep the foam as dry as possible and remove it with a vacuum cleaner.

If your airplane is equipped with leather seating, cleaning of the seats is accomplished using a soft cloth or sponge dipped in mild soap suds. The soap suds, used sparingly, will remove traces of dirt and grease. The soap should be removed with a clean damp cloth.

The plastic trim, headliner, instrument panel and control knobs need only be wiped off with a damp cloth. Oil and grease on the control wheel and control knobs can be removed with a cloth moistened with Stoddard solvent. Volatile solvents, such as mentioned in paragraphs on care of the windshield, must never be used since they soften and craze the plastic.



# SECTION 9 SUPPLEMENTS

## (Optional Systems Description & Operating Procedures)

### TABLE OF CONTENTS

#### Introduction

#### Supplements:

Emergency Locator Transmitter (ELT) . . . . .	(4 pages)
Electric Elevator Trim System . . . . .	(2 pages)
Cessna 300 Nav/Com (Type RT-385A) . . . . .	(8 pages)
Cessna 300 Nav/Com (Type RT-385A) With Cessna 400 Area Navigation System (Type RN-478A) . . . . .	(8 pages)
Cessna 300 ADF (Type R-546E) . . . . .	(6 pages)
Cessna 300 Transponder (Type RT-359A) And Optional Encoding Altimeter (Type EA-401A) . . . . .	(6 pages)
Cessna 300 Transponder (Type RT-359A) And Optional Altitude Encoder (Blind) . . . . .	(6 pages)
DME (Type 190) . . . . .	(4 pages)
HF Transceiver (Type PT10-A) . . . . .	(4 pages)
SSB HF Transceiver (Type ASB-125) . . . . .	(4 pages)
Cessna 400 Nav/Com (Type RT-485A) . . . . .	(10 pages)
Cessna 400 Nav/Com (Type RT-485A) With Cessna 400 Area Navigation System (Type RN-478A) . . . . .	(10 pages)
Cessna 400 Area Navigation System (Type RN-478A) . . . . .	(6 pages)
Cessna 400 ADF (Type R-446A) . . . . .	(6 pages)
Cessna 400 DME (Type R-476A) . . . . .	(4 pages)
Cessna 400 Marker Beacon (Type R-402A) . . . . .	(4 pages)
Cessna 400 Transponder (Type RT-459A) And Optional Encoding Altimeter (Type EA-401A) . . . . .	(6 pages)
Cessna 400 Transponder (Type RT-459A) And Optional Altitude Encoder (Blind) . . . . .	(6 pages)
Cessna 400 Glide Slope (Type R-443B) . . . . .	(4 pages)
Cessna Horizontal Situation Indicator (Type IG-832C) . . . . .	(6 pages)
Cessna 200A Navomatic Autopilot (Type AF-295B) . . . . .	(6 pages)
Cessna 300A Navomatic Autopilot (Type AF-395A) . . . . .	(6 pages)

## **INTRODUCTION**

**This section consists of a series of supplements, each covering a single optional system which may be installed in the airplane. Each supplement contains a brief description, and when applicable, operating limitations, emergency and normal procedures, and performance. Other routinely installed items of optional equipment, whose function and operational procedures do not require detailed instructions, are discussed in Section 7.**

# SUPPLEMENT

## EMERGENCY LOCATOR TRANSMITTER (ELT)

### SECTION 1 GENERAL

The ELT consists of a self-contained dual-frequency radio transmitter and battery power supply, and is activated by an impact of 5g or more as may be experienced in a crash landing. The ELT emits an omni-directional signal on the international distress frequencies of 121.5 and 243.0 MHz. (Some ELT units in export aircraft transmit only on 121.5 MHz.) General aviation and commercial aircraft, the FAA, and CAP monitor 121.5 MHz, and 243.0 MHz is monitored by the military. Following a crash landing, the ELT will provide line-of-sight transmission up to 100 miles at 10,000 feet. The ELT supplied in domestic aircraft transmits on both distress frequencies simultaneously at 75 mw rated power output for 48 continuous hours in the temperature range of -40°F to +131°F (-40°C to +55°C). The ELT unit in export aircraft transmits on 121.5 MHz at 25 mw rated power output for 100 continuous hours in the temperature range of -40°F to +131°F (-40°C to +55°C).

The ELT is readily identified as a bright orange unit mounted behind the baggage compartment wall in the tailcone. To gain access to the unit, remove the baggage compartment wall. The ELT is operated by a control panel at the forward facing end of the unit (see figure 1.)

### SECTION 2 LIMITATIONS

There is no change to the airplane limitations when this equipment is installed.

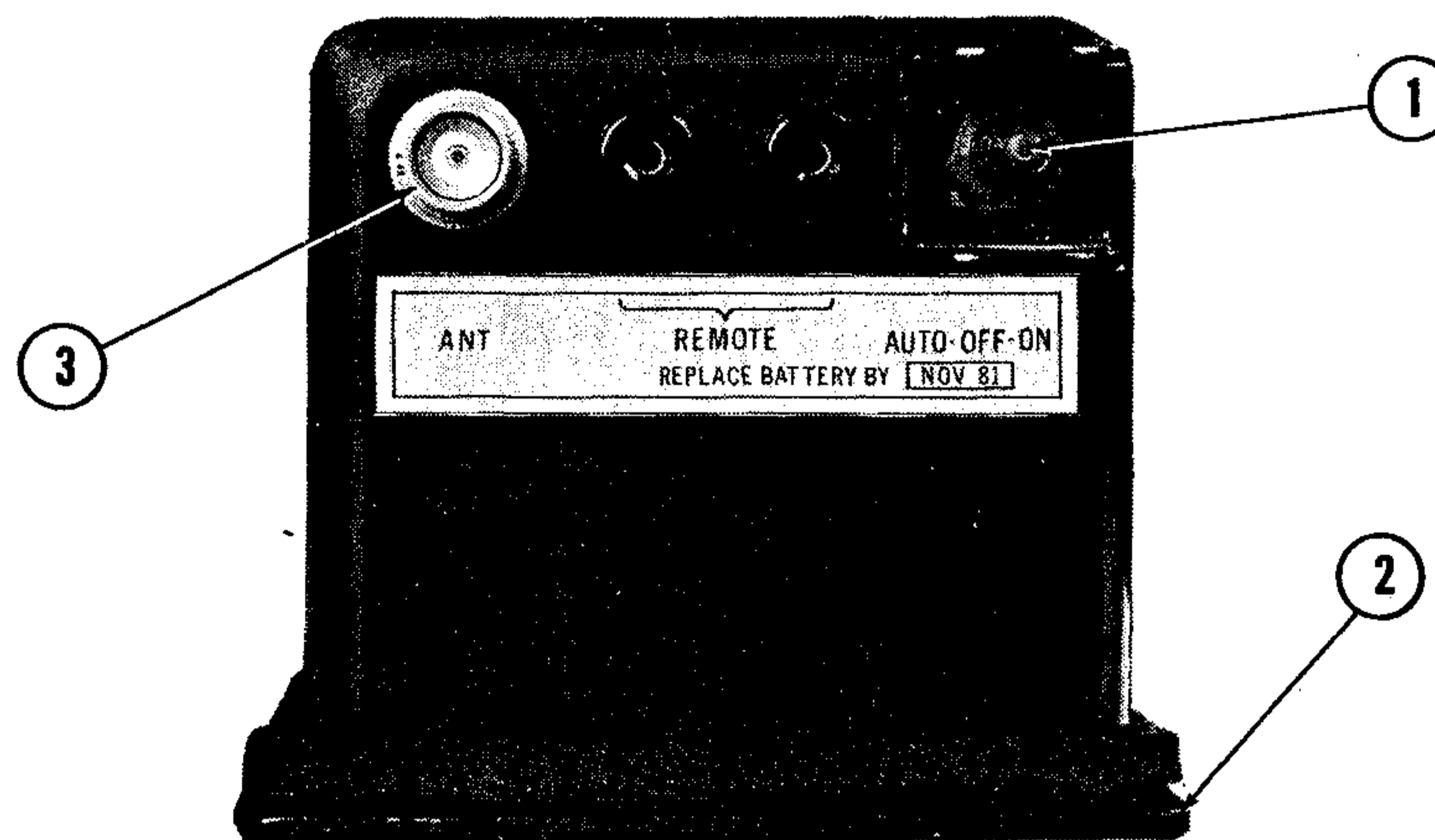

1. **FUNCTION SELECTOR SWITCH (3-position toggle switch):**
  - ON - Activates transmitter instantly. Used for test purposes and if "g" switch is inoperative.
  - OFF - Deactivates transmitter. Used during shipping, storage and following rescue.
  - AUTO - Activates transmitter only when "g" switch receives 5g or more impact.
2. **COVER** - Removable for access to battery pack.
3. **ANTENNA RECEPTACLE** - Connects to antenna mounted on top of tailcone.

Figure 1. ELT Control Panel

## SECTION 3

### EMERGENCY PROCEDURES

Immediately after a forced landing where emergency assistance is required, the ELT should be utilized as follows.

1. **ENSURE ELT ACTIVATION** --Turn a radio transceiver ON and select 121.5 MHz. If the ELT can be heard transmitting, it was activated by the "g" switch and is functioning properly. If no emergency tone is audible, gain access to the ELT and place the function selector switch in the ON position.

2. PRIOR TO SIGHTING RESCUE AIRCRAFT -- Conserve airplane battery. Do not activate radio transceiver.
3. AFTER SIGHTING RESCUE AIRCRAFT -- Place ELT function selector switch in the OFF position, preventing radio interference. Attempt contact with rescue aircraft with the radio transceiver set to a frequency of 121.5 MHz. If no contact is established, return the function selector switch to ON immediately.
4. FOLLOWING RESCUE -- Place ELT function selector switch in the OFF position, terminating emergency transmissions.

## SECTION 4 NORMAL PROCEDURES

As long as the function selector switch remains in the AUTO position, the ELT automatically activates following an impact of 5g or more over a short period of time.

Following a lightning strike, or an exceptionally hard landing, the ELT may activate although no emergency exists. To check your ELT for inadvertent activation, select 121.5 MHz on your radio transceiver and listen for an emergency tone transmission. If the ELT can be heard transmitting, place the function selector switch in the OFF position and the tone should cease. Immediately place the function selector switch in the AUTO position to re-set the ELT for normal operation.

## SECTION 5 PERFORMANCE

There is no change to the airplane performance data when this equipment is installed.



# SUPPLEMENT

## ELECTRIC ELEVATOR TRIM SYSTEM (MODEL R182)

### SECTION 1 GENERAL

The electric elevator trim system provides a simple method of relieving pitch control pressures without interrupting other control operations to adjust the manual elevator trim wheel. The system is controlled by a slide-type trim switch on the top of the left control wheel grip and a disengage switch located on the upper left side of the control wheel pad. Pushing the trim switch to the forward position, labeled DN, moves the elevator trim tab in the "nose down" direction; conversely, pulling the switch aft to the UP position moves the tab in the "nose up" direction. When the switch is released, it automatically returns to the center off position, and elevator trim tab motion stops. The disengage switch, labeled ELEC TRIM DISENGAGE, disables the system when placed in the DISENGAGE (aft) position.

A servo unit (which includes a motor and chain-driven, solenoid-operated clutch) actuates the trim tab to the selected position. When the clutch is not energized (trim switch off) the electric portion of the trim system freewheels so that manual operation is not affected. The electric trim system can be overridden at any time by manually rotating the elevator trim wheel, thus overriding the servo that drives the trim tab.

### SECTION 2 LIMITATIONS

There is no change to the airplane limitations when this trim system is installed. However, the following information is presented on a placard at the top of the instrument panel:

Maximum Altitude Loss During  
Electric Trim Malfunction - 260 Ft.

### SECTION 3

## EMERGENCY PROCEDURES

1. Elevator Trim Disengage Switch -- DISENGAGE.

#### NOTE

For maximum altitude loss during an electric trim malfunction, refer to placarding on the instrument panel.

2. Manual Trim -- AS REQUIRED.

### SECTION 4

## NORMAL PROCEDURES

To operate the electric elevator trim system, proceed as follows:

1. Master Switch -- ON.
2. Elevator Trim Disengage Switch -- ON.
3. Trim Switch -- ACTUATE as desired.
4. Elevator Trim Position Indicator -- CHECK.

#### NOTE

To check the operation of the disengage switch, actuate the elevator trim switch with the disengage switch in the DISENGAGE (aft) position. Observe that the manual trim wheel and indicator do not rotate when the elevator trim switch is activated.

### SECTION 5

## PERFORMANCE

There is no change to the airplane performance when this trim system is installed.



## SUPPLEMENT

# CESSNA 300 NAV/COM (720-Channel - Type RT-385A)

## SECTION 1

### GENERAL

The Cessna 300 Nav/Com (Type RT-385A), shown in figure 1, consists of a panel-mounted receiver-transmitter and a single or dual-pointer remote course deviation indicator.

The set includes a 720-channel VHF communications receiver-transmitter and a 200-channel VHF navigation receiver, both of which may be operated simultaneously. The communications receiver-transmitter receives and transmits signals between 118.000 and 135.975 MHz in 25-kHz steps. The navigation receiver receives omni and localizer signals between 108.00 and 117.95 MHz in 50-kHz steps. The circuits required to interpret the omni and localizer signals are located in the course deviation indicator. Both the communications and navigation operating frequencies are digitally displayed by incandescent readouts on the front panel of the Nav/Com.

A DME receiver-transmitter or a glide slope receiver, or both, may be interconnected with the Nav/Com set for automatic selection of the associated DME or glide slope frequency. When a VOR frequency is selected on the Nav/Com, the associated VORTAC or VOR-DME station frequency will also be selected automatically; likewise, if a localizer frequency is selected, the associated glide slope frequency will be selected automatically.

The course deviation indicator includes either a single-pointer and related NAV flag for VOR/LOC indication only, or dual pointers and related NAV and GS flags for both VOR/LOC and glide slope indications. Both types of course deviation indicators incorporate a back-course lamp (BC) which lights when optional back course (reversed sense) operation is selected. Both types may be provided with Automatic Radial Centering which, depending on how it is selected, will automatically indicate the bearing TO or FROM the VOR station.

All controls for the Nav/Com, except the standard omni bearing selector (OBS) knob or the optional automatic radial centering (ARC) knob located on the course deviation indicator, are mounted on the front panel of

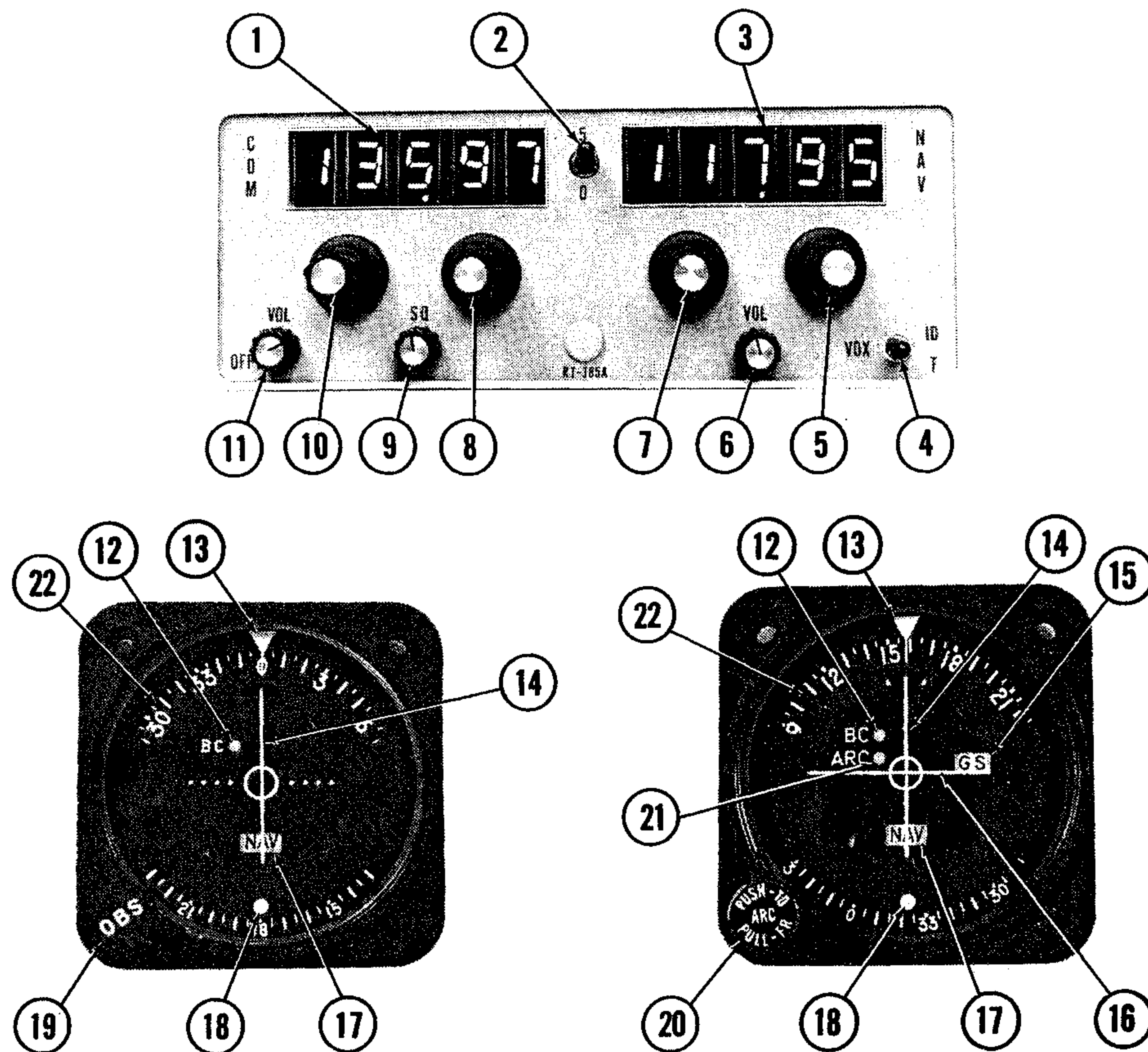

1. COMMUNICATION OPERATING FREQUENCY READOUT (Third-decimal-place is shown by the position of the "5-0" switch).
2. 5-0 SWITCH - Part of Com Receiver-Transmitter Fractional MHz Frequency Selector. In "5" position, enables Com frequency readout to display and Com Fractional MHz Selector to select frequency in .05-MHz steps between .025 and .975 MHz. In "0" position, enables COM frequency readout to display and Com Fractional MHz Selector to select frequency in .05-MHz steps between .000 and .950 MHz.

NOTE

The "5" or "0" may be read as the third decimal digit, which is not displayed in the Com fractional frequency display.

Figure 1. Cessna 300 Nav/Com (Type RT-385A), Operating Controls and Indicators (Sheet 1 of 3)

3. NAVIGATION OPERATING FREQUENCY READOUT.
4. ID-VOX-T SWITCH - With VOR or LOC station selected, in ID position, station identifier signal is audible; in VOX (Voice) position, identifier signal is suppressed; in T (Momentary On) position, the VOR navigational self-test function is selected.
5. NAVIGATION RECEIVER FRACTIONAL MEGAHERTZ SELECTOR - Selects Nav frequency in .05-MHz steps between .00 and .95 MHz; simultaneously selects paired glide slope frequency and DME channel.
6. NAV VOL CONTROL - Adjusts volume of navigation receiver audio.
7. NAVIGATION RECEIVER MEGAHERTZ SELECTOR - Selects NAV frequency in 1-MHz steps between 108 and 117 MHz; simultaneously selects paired glide slope frequency and DME channel.
8. COMMUNICATION RECEIVER-TRANSMITTER FRACTIONAL MEGAHERTZ SELECTOR - Depending on position of 5-0 switch, selects COM frequency in .05-MHz steps between .000 and .975 MHz. The 5-0 switch identifies the last digit as either 5 or 0.
9. SQUELCH CONTROL - Used to adjust signal threshold necessary to activate COM receiver audio. Clockwise rotation increases background noise (decreases squelch action); counterclockwise rotation decreases background noise.
10. COMMUNICATION RECEIVER-TRANSMITTER MEGAHERTZ SELECTOR - Selects COM frequency in 1-MHz steps between 118 and 135 MHz.
11. COM OFF-VOL CONTROL - Combination on/off switch and volume control; turns on NAV/COM set and controls volume of communications receiver audio.
12. BC LAMP - Amber light illuminates when the autopilot or reverse sense option is installed and the reverse sense switch or autopilot's back-course function is engaged; indicates course deviation pointer is reversed on selected receiver when tuned to a localizer frequency.
13. COURSE INDEX - Indicates selected VOR course.
14. COURSE DEVIATION POINTER - Indicates course deviation from selected omni course or localizer centerline.
15. GLIDE SLOPE "GS" FLAG - When visible, red GS flag indicates unreliable glide slope signal or improperly operating equipment. Flag disappears when a reliable glide slope signal is being received.
16. GLIDE SLOPE DEVIATION POINTER - Indicates deviation from ILS glide slope.
17. NAV/TO-FROM INDICATOR - Operates only with a VOR or localizer signal. Red NAV position (Flag) indicates unusable signal. With usable VOR signal, indicates whether selected course is TO or FROM station. With usable localizer signal, shows TO.

Figure 1. Cessna 300 Nav/Com (Type RT-385A), Operating Controls and Indicators (Sheet 3 of 3)

18. RECIPROCAL COURSE INDEX - Indicates reciprocal of selected VOR course.
19. OMNI BEARING SELECTOR (OBS) - Rotates course card to select desired course.
20. AUTOMATIC RADIAL CENTERING (ARC - PUSH-TO/PULL-FR) SELECTOR - In center detent, functions as conventional OBS. Pushed to inner (Momentary On) position, turns OBS course card to center course deviation pointer with a TO flag, then returns to conventional OBS selection. Pulled to outer detent, continuously drives OBS course card to indicate bearing from VOR station, keeping course deviation pointer centered, with a FROM flag. ARC function will not operate on localizer frequencies.
21. AUTOMATIC RADIAL CENTERING (ARC) LAMP - Amber light illuminates when Automatic Radial Centering is in use.
22. COURSE CARD - Indicates selected VOR course under course index.

Figure 1. Cessna 300 Nav/Com (Type RT-385A), Operating Controls and Indicators (Sheet 2 of 3)

the receiver-transmitter. In addition, when two or more radios are installed, aircraft mounted transmitter selector and speaker/phone switches are provided.

## SECTION 2 LIMITATIONS

There is no change to the airplane limitations when this avionic equipment is installed. However, the pilot should be aware that on many Cessna airplanes equipped with the windshield mounted glide slope antenna, pilots should avoid use of  $2700 \pm 100$  RPM (or  $1800 \pm 100$  RPM with a three bladed propeller) during ILS approaches to avoid oscillations of the glide slope deviation pointer caused by propeller interference.

## SECTION 3 EMERGENCY PROCEDURES

There is no change to the airplane emergency procedures when this avionic equipment is installed. However, if the frequency readouts fail, the radio will remain operational on the last frequency selected. The frequency controls should not be moved due to the difficulty of obtaining a known frequency under this condition.

## SECTION 4 NORMAL PROCEDURES

### COMMUNICATION RECEIVER-TRANSMITTER OPERATION:

1. COM OFF/VOL Control -- TURN ON; adjust to desired audio level.
2. XMTR SEL Switch -- SET to desired 300 Nav/Com (on audio control panel).
3. SPEAKER/PHONE (or AUTO) Switch -- SET to desired mode (on audio control panel).
4. 5-0 Fractional MHz Selector Switch -- SELECT desired operating frequency (does not affect navigation frequencies).
5. COM Frequency Selector Switches -- SELECT desired operating frequency.
6. SQ Control -- ROTATE counterclockwise to decrease background noise as required.

7. Mike Button:
  - a. To Transmit -- DEPRESS and SPEAK into microphone.

**NOTE**

Sidetone may be selected by placing the AUTO selector switch (on audio control panel) in either the SPEAKER or PHONE position. Adjustment of sidetone may be accomplished by adjusting the sidetone pot located inside the audio control panel.

- b. To Receive -- RELEASE mike button.

**NAVIGATION OPERATION:**

1. COM OFF/VOL Control -- TURN ON.
2. SPEAKER/PHONE (or AUTO) Switch -- SET to desired mode (on audio control panel).
3. NAV Frequency Selector Knobs -- SELECT desired operating frequency.
4. NAV VOL -- ADJUST to desired audio level.
5. ID-VOX-T Switch:
  - a. To Identify Station -- SET to ID to hear navigation station identifier signal.
  - b. To Filter Out Station Identifier Signal -- SET to VOX to include filter in audio circuit.
6. ARC PUSH-TO/PULL-FROM Knob (If Applicable):
  - a. To Use As Conventional OBS -- PLACE in center detent and select desired course.
  - b. To Obtain Bearing TO VOR Station -- PUSH (ARC/PUSH-TO) knob to inner (momentary on) position.

**NOTE**

ARC lamp will illuminate amber while the course card is moving to center with the course deviation pointer. After alignment has been achieved to reflect bearing to VOR, automatic radial centering will automatically shut down, causing the ARC lamp to go out.

- c. To Obtain Continuous Bearing FROM VOR Station -- PULL (ARC/PULL-FR) knob to outer detent.

**NOTE**

ARC lamp will illuminate amber, OBS course card will

turn to center the course deviation pointer with a FROM flag to indicate bearing from VOR station.

7. OBS Knob (If Applicable) -- SELECT desired course.

**VOR SELF-TEST OPERATION:**

1. COM OFF/VOL Control -- TURN ON.
2. NAV Frequency Selector Switches -- SELECT usable VOR station signal.
3. OBS Knob -- SET for 0° course at course index; course deviation pointer centers or deflects left or right, depending on bearing of signal; NAV/TO-FROM indicator shows TO or FROM.
4. ID/VOX/T Switch -- PRESS to T and HOLD at T; course deviation pointer centers and NAV/TO-FROM indicator shows FROM.
5. OBS Knob -- TURN to displace course approximately 10° to either side of 0° (while holding ID/VOX/T to T). Course deviation pointer deflects full scale in direction corresponding to course displacement. NAV/TO-FROM indicator shows FROM.
6. ID/VOX/T Switch -- RELEASE for normal operation.

**NOTE**

This test does not fulfill the requirements of FAR 91.25.

## **SECTION 5 PERFORMANCE**

There is no change to the airplane performance when this avionic equipment is installed. However, the installation of an externally mounted antenna or several related external antennas, will result in a minor reduction in cruise performance.





## **SUPPLEMENT**

### **CESSNA 300 NAV/COM (Type RT-385A)**

### **WITH**

### **CESSNA 400 AREA NAVIGATION SYSTEM (Type RN-478A)**

## **SECTION 1 GENERAL**

The Cessna 300 Nav/Com (Type RT-385A) Set with Cessna 400 Area Navigation (RNAV-Type RN-478A) consists of a RT-385A Nav/Com, a R-476A DME system, a RN-478A Area Navigation Computer and a IN-442AR Course Deviation Indicator. The RN-478A includes circuits which combine the VOR navigation information with distance information from the R-476A DME system to provide data for area navigation. Operating information for the communication set and for VOR/localizer navigation is presented in this supplement. Operating information for area navigation and for DME is presented in separate supplements.

The RT-385A Receiver-Transmitter includes a 720-channel VHF communication receiver-transmitter which receives and transmits signals between 118.000 MHz and 135.975 MHz in 25-kHz steps. It also includes a 200-channel VHF navigation receiver which receives VOR and localizer signals between 108.00 MHz and 117.95 MHz in 50-kHz steps. The communication receiver-transmitter and the navigation receiver can be operated simultaneously.

The VOR or localizer signal from the navigation receiver is applied to the converter circuits in the RN-478A Area Navigation Computer. The

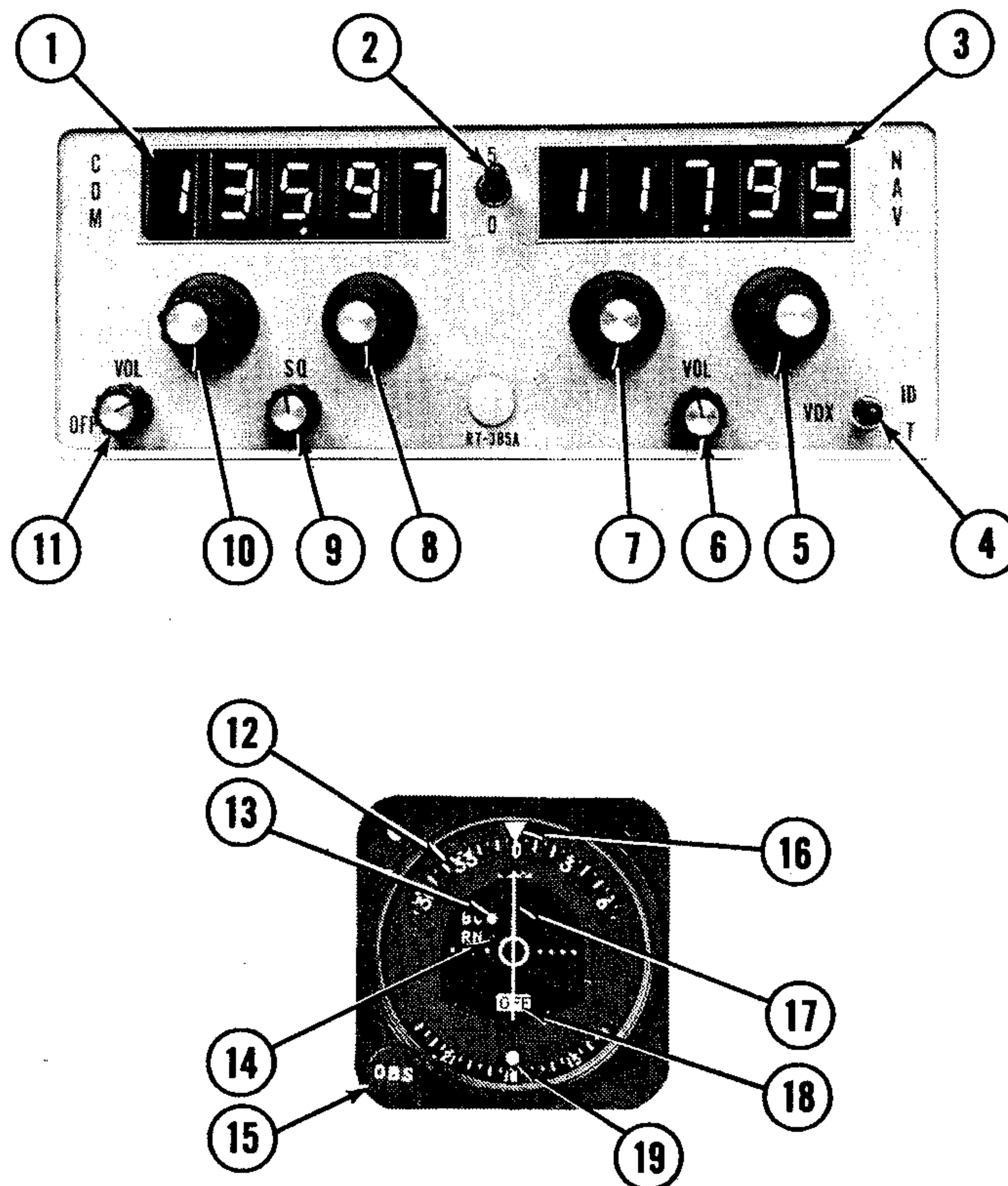

1. COMMUNICATION OPERATING FREQUENCY READOUT (Third-decimal-place is shown by the position of the "5-0" switch).
2. 5-0 SWITCH - Part of COM Receiver-Transmitter Fractional MHz Frequency Selector. In "5" position, enables COM frequency readout to display and COM Fractional MHz Selector to select frequency in .05 MHz steps between .025 and .975 MHz. In "0" position, enables COM frequency readout to display and COM Fractional MHz Selector to select frequency in .05 MHz steps between .000 and .950 MHz.

NOTE

The "5" or "0" may be read as the third decimal digit, which is not displayed in the Com fractional frequency display.

Figure 1. Cessna 300 Nav/Com Set, Operating Controls and Indicators  
(Sheet 1 of 3)

3. NAVIGATION OPERATING FREQUENCY READOUT.
4. ID-VOX-T SWITCH - With VOR or LOC station selected, in ID position, station identifier signal is audible; in center VOX (Voice) position, identifier signal is suppressed; in T (Momentary On) position, the VOR navigational self-test function is selected.
5. NAVIGATIONAL RECEIVER FRACTIONAL MEGAHERTZ FREQUENCY SELECTOR - Selects NAV frequency in .05 MHz steps between .00 and .95 MHz; simultaneously selects paired glide slope frequency and DME channel.
6. NAV VOLUME CONTROL (VOL) - Adjusts volume of navigation receiver audio. Clockwise rotation increases audio level.
7. NAVIGATION RECEIVER MEGAHERTZ FREQUENCY SELECTOR - Selects NAV frequency in 1-MHz steps between 108 and 117 MHz; simultaneously selects paired glide slope frequency and DME channel.
8. COMMUNICATION RECEIVER-TRANSMITTER FRACTIONAL MHz FREQUENCY SELECTOR - Depending on position of the 5-0 Switch, selects COM frequency in .05 MHz steps between .000 and .975 MHz. The 5-0 switch identifies the last digit as either 5 or 0.
9. SQUELCH CONTROL - Used to adjust signal threshold necessary to activate COM receiver audio. Clockwise rotation increases background noise (decreases squelch action); counterclockwise rotation decreases background noise.
10. COMMUNICATION RECEIVER-TRANSMITTER MHz FREQUENCY SELECTOR - Selects COM frequency in 1 MHz steps between 118 and 135 MHz.
11. COM OFF-VOL CONTROL - Combination on/off switch and volume control; turns on NAV/COM Set and RNAV Computer circuits; controls volume of communication receiver audio.
12. COURSE CARD - Indicates selected VOR course under course index.
13. BACK COURSE LAMP (BC) - Amber light illuminates when an autopilot with reverse sense feature is installed and the reverse sense switch or the autopilot's back-course function is engaged and receiver is tuned to a localizer frequency; indicates course deviation pointer is reversed.
14. AREA NAV LAMP (RN) - When green light is illuminated, indicates that RNAV operation is selected.
15. OMNI BEARING SELECTOR (OBS) - Rotates course card (12) to select desired bearing to or from a VOR station or to a selected RNAV waypoint.
16. COURSE INDEX - Indicates selected VOR or RNAV course (bearing).
17. COURSE DEVIATION POINTER - Indicates deviation from selected VOR or RNAV course or localizer centerline.

Figure 1. Cessna 300 Nav/Com Set, Operating Controls and Indicators  
(Sheet 2 of 3)

18. OFF/TO-FROM INDICATOR - Operates only with VOR or localizer signal. OFF position (flag) indicates unusable signal. With usable VOR signal, when OFF position disappears, indicates whether selected course is TO or FROM station or waypoint. With usable localizer signal, shows TO.
19. RECIPROCAL COURSE INDEX - Indicates reciprocal of selected VOR or RNAV course.

Figure 1. Cessna 300 Nav/Com Set, Operating Controls and Indicators  
(Sheet 3 of 3)

converter processes the received navigation signal to provide omni bearing or localizer information for display by the course indicator.

### **CAUTION**

If the RNAV set is removed from the airplane or becomes inoperative, the associated VHF navigation indicator will be inoperative.

The course indicator includes a Course Deviation Indicator (CDI), an Omni Bearing Selector (OBS) and OFF/TO-FROM Indicator Flags. It also includes an RNAV lamp (RN) which lights when area navigation operation is selected, and a back-course lamp (BC) which lights when back-course operation is selected. The IN-442AR is offered as the standard Course Deviation Indicator.

All operating controls and indicators for the Cessna 300 Nav/Com are included on the front panel of the RT-385A Receiver-Transmitter and the associated Course Deviation Indicator. These controls and indicators are shown and described in Figure 1. Operating controls for the RN-478A Area Navigation Computer, which are used for area navigation, and operating controls for the associated Type R-476A DME are shown in the appropriate supplements in this manual.

## **SECTION 2 LIMITATIONS**

There is no change to the airplane limitations when this avionic equipment is installed. However, the pilot should be aware that on many Cessna airplanes equipped with the windshield mounted glide slope antenna, pilots should avoid use of  $2700 \pm 100$  RPM on airplanes equipped with a two-bladed propeller or  $1800 \pm 100$  RPM on airplanes equipped with a three-bladed propeller during ILS approaches to avoid oscillations of the glide slope deviation pointer caused by propeller interference.

## **SECTION 3 EMERGENCY PROCEDURES**

There is no change to the airplane emergency procedures when this avionic equipment is installed. However, if the frequency readouts fail, the radio will remain operational on the last frequency selected. The frequency controls should not be moved due to the difficulty of obtaining a known frequency under this condition.

## SECTION 4

### NORMAL PROCEDURES

#### COMMUNICATIONS TRANSCEIVER OPERATION:

1. COM OFF/VOL Control -- TURN ON; adjust to desired audio level.
2. XMTR SEL Switch -- SET to desired 300 NAV/COM (on audio control panel).
3. SPEAKER PHONE (or AUTO) Switch -- SET to desired mode (on audio control panel).
4. 5-0 Fractional MHz Selector Switch -- SELECT desired operating frequency (does not affect navigation frequencies).
5. COM Frequency Selector Knobs -- SELECT desired operating frequency.
6. SQ Control -- ROTATE counterclockwise to decrease background noise as required.
7. Mike Button:
  - a. To Transmit -- DEPRESS and SPEAK into microphone.

#### NOTE

Sidetone may be selected by placing the AUTO selector switch (on audio control panel) in either the SPEAKER or PHONE position. Adjustment of sidetone may be accomplished by adjusting the sidetone pot located inside the audio control panel.

- b. To Receive -- RELEASE mike button.

#### NAVIGATION RECEIVER OPERATION:

1. COM OFF/VOL Control -- TURN ON.
2. SPEAKER/PHONE (or AUTO) Switch -- SET to desired mode (on audio control panel).
3. NAV Frequency Selector Knobs -- SELECT desired operating frequency.
4. NAV VOL Control -- ADJUST to desired audio level.
5. ID-VOX-T Switch:
  - a. To Identify Station -- SET to ID to hear navigation station identifier (Morse Code) signal.
  - b. To Filter Out Station Identifier Signal -- SET to VOX (center) position to include filter in audio circuit.
6. OBS Knob -- SELECT desired course.

#### TO SELF TEST VOR NAVIGATION CIRCUITS:

1. COM OFF/VOL Control -- TURN ON.
2. NAV Frequency Selector Switches -- SELECT usable VOR station signal.

3. OBS Knob -- SET for 0° course at index; CDI pointer centers or deflects left or right, depending on bearing of signal; OFF/TO-FROM indicator shows TO or FROM.
4. ID-VOX-T Switch -- PRESS to T and HOLD at T; CDI pointer should center and OFF/TO-FROM indicator should show FROM.
5. OBS Knob -- TURN to displace course approximately 10° to either side of 0° (while holding ID-VOX-T switch at T); CDI pointer should deflect full scale in direction corresponding to course displacement. OFF/TO-FROM indicator should still show FROM.

NOTE

This test does not fulfill the requirements of FAR 91.25.

## SECTION 5 PERFORMANCE

There is no change to the airplane performance when this avionic equipment is installed. However, the installation of an externally mounted antenna or several related external antennas, will result in a minor reduction in cruise performance.





# **SUPPLEMENT**

## **CESSNA 300 ADF**

### **(Type R-546E)**

#### **SECTION 1**

#### **GENERAL**

The Cessna 300 ADF is a panel-mounted, digitally tuned automatic direction finder. It is designed to provide continuous 1 kHz digital tuning in the frequency range of 200 kHz to 1,699 kHz and eliminates the need for mechanical band switching. The system is comprised of a receiver, loop antenna, bearing indicator and a sense antenna. In addition, when two or more radios are installed, speaker-phone selector switches are provided. Each control function is described in Figure 1.

The Cessna 300 ADF can be used for position plotting and homing procedures, and for aural reception of amplitude-modulated (AM) signals.

With the function selector knob at ADF, the Cessna 300 ADF provides a visual indication, on the bearing indicator, of the bearing to the transmitting station relative to the nose of the airplane. This is done by combining signals from the sense antenna with signals from the loop antenna.

With the function selector knob at REC, the Cessna 300 ADF uses only the sense antenna and operates as a conventional low-frequency receiver.

The Cessna 300 ADF is designed to receive transmission from the following radio facilities: commercial broadcast stations, low-frequency range stations, FAA radio beacons, and ILS compass locators.

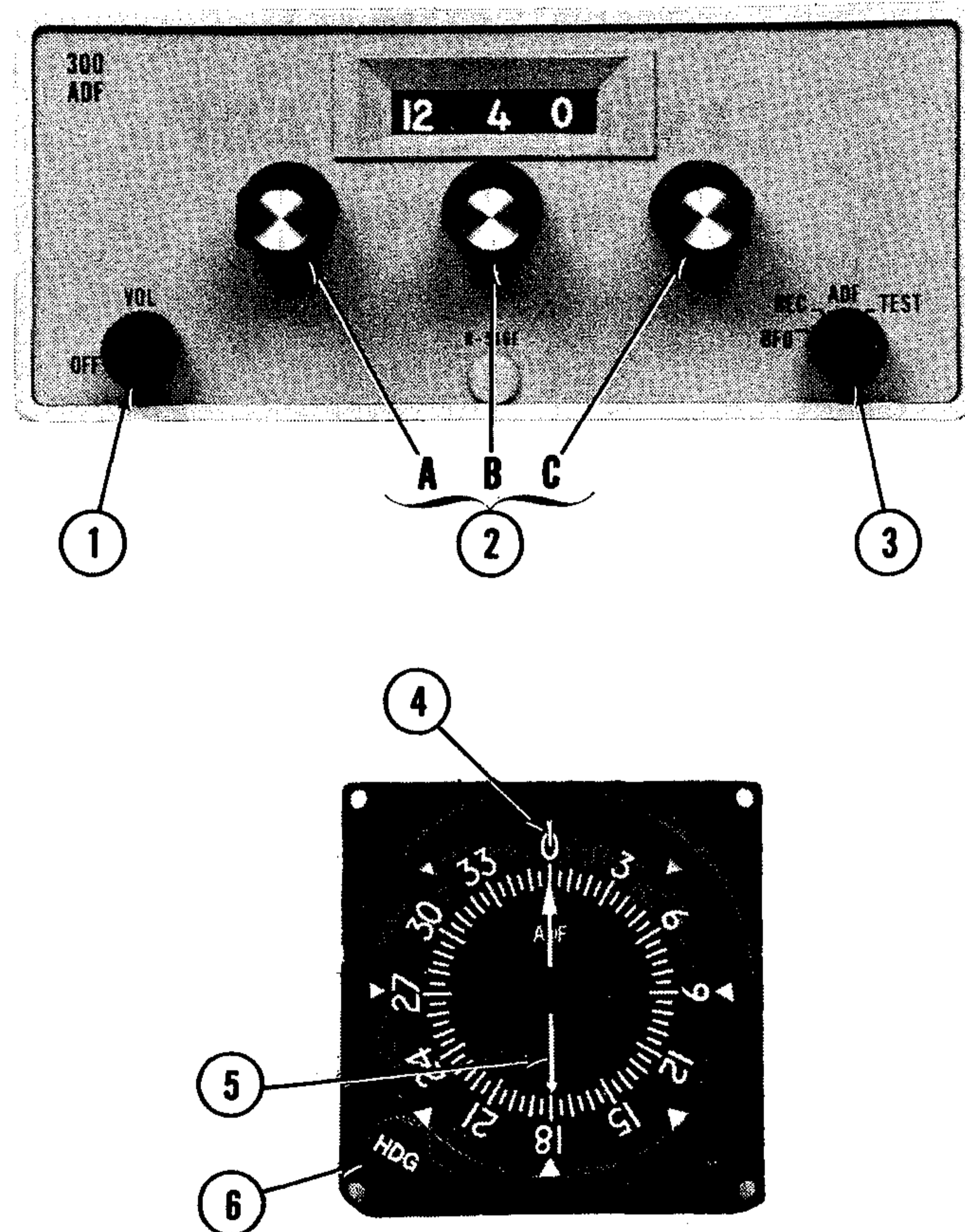

1. **OFF/VOL CONTROL** - Controls primary power and audio output level. Clockwise rotation from OFF position applies primary power to receiver; further clockwise rotation increases audio level.
2. **FREQUENCY SELECTORS** - Knob (A) selects 100-kHz increments of receiver frequency, knob (B) selects 10-kHz increments, and knob (C) selects 1-kHz increments.

Figure 1. Cessna 300 ADF Operating Controls and Indicators (Sheet 1 of 2)

3. FUNCTION SWITCH:

BFO: Selects operation as communication receiver using only sense antenna and activates 1000-Hz tone beat frequency oscillator to permit coded identifier of stations transmitting keyed CW signals (Morse Code) to be heard.

REC: Selects operation as standard communication receiver using only sense antenna.

ADF: Set operates as automatic direction finder using loop and sense antennas.

TEST: Momentary-on position used during ADF operation to test bearing reliability. When held in TEST position, slews indicator pointer clockwise; when released, if bearing is reliable, pointer returns to original bearing position.

4. INDEX (ROTATABLE CARD) - Indicates relative, magnetic, or true heading of aircraft, as selected by HDG control.

5. POINTER - Indicates station bearing in degrees of azimuth, relative to the nose of the aircraft. When heading control is adjusted, indicates relative, magnetic, or true bearing of radio signal.

6. HEADING CONTROL (HDG) - Rotates card to set in relative, magnetic, or true bearing information.

Figure 1. Cessna 300 ADF Operating Controls and Indicators (Sheet 2 of 2)

## SECTION 2 LIMITATIONS

There is no change to the airplane limitations when this avionic equipment is installed.

## SECTION 3 EMERGENCY PROCEDURES

There is no change to the airplane emergency procedures when this avionic equipment is installed.

## SECTION 4 NORMAL PROCEDURES

TO OPERATE AS A COMMUNICATIONS RECEIVER ONLY:

- (1) OFF/VOL Control -- ON.
- (2) Function Selector Knob -- REC.
- (3) Frequency Selector Knobs -- SELECT operating frequency.
- (4) ADF SPEAKER/PHONE Switch -- SELECT speaker or phone position as desired.
- (5) VOL Control -- ADJUST to desired listening level.

TO OPERATE AS AN AUTOMATIC DIRECTION FINDER:

- (1) OFF/VOL Control -- ON.
- (2) Frequency Selector Knobs -- SELECT operating frequency.
- (3) ADF SPEAKER/PHONE Switch -- SELECT speaker or phone position.
- (4) Function Selector Knob -- ADF position and note relative bearing on indicator.
- (5) VOL Control -- ADJUST to desired listening level.

TO TEST RELIABILITY OF AUTOMATIC DIRECTION FINDER:

- (1) Function Selector Knob -- ADF position and note relative bearing on indicator.
- (2) Function Selector Knob -- TEST position and observe that pointer moves away from relative bearing at least 10 to 20 degrees.
- (3) Function Selector Knob -- ADF position and observe that pointer returns to same relative bearing as in step (1).

**TO OPERATE BFO:**

- (1) OFF/VOL Control -- ON.
- (2) Function Selector Knob -- BFO.
- (3) Frequency Selector Knobs -- SELECT operating frequency.
- (4) ADF SPEAKER/PHONE Switch -- SELECT speaker or phone position.
- (5) VOL Control -- ADJUST to desired listening level.

**NOTE**

A 1000-Hz tone is heard in the audio output when a CW signal (Morse Code) is tuned in properly.

## **SECTION 5**

### **PERFORMANCE**

There is no change to the airplane performance when this avionic equipment is installed. However, the installation of an externally mounted antenna or several related external antennas, will result in a minor reduction in cruise performance.

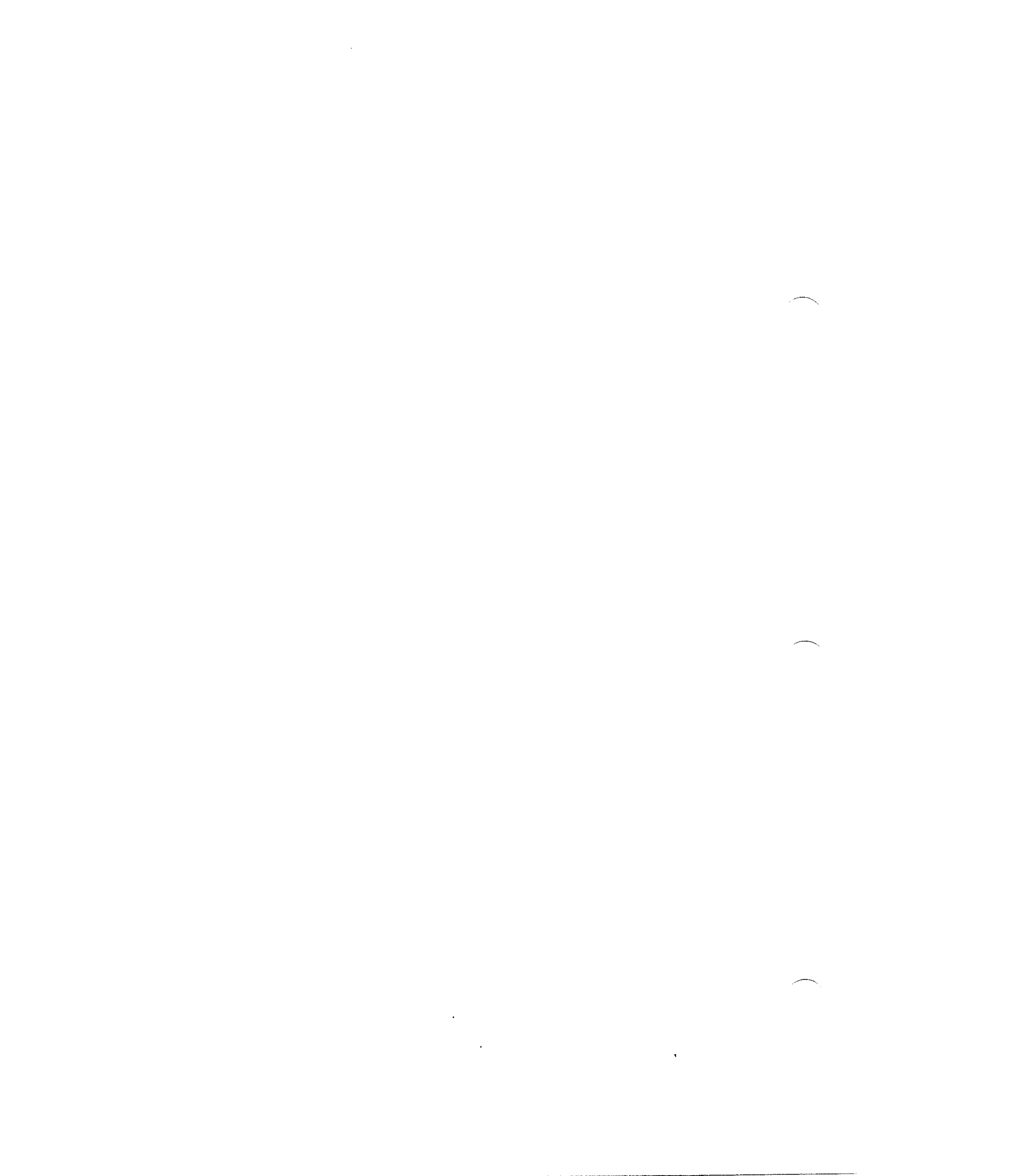

**SUPPLEMENT**

**CESSNA 300 TRANSPONDER**  
**(Type RT-359A)**

**AND**

**OPTIONAL ENCODING ALTIMETER**  
**(Type EA-401A)**

**SECTION 1**

**GENERAL**

The Cessna 300 Transponder (Type RT-359A), shown in Figure 1, is the airborne component of an Air Traffic Control Radar Beacon System (ATCRBS). The transponder enables the ATC ground controller to "see" and identify the aircraft, while in flight, on the control center's radar-scope more readily.

The Cessna 300 Transponder consists of a panel-mounted unit and an externally-mounted antenna. The transponder receives interrogating pulse signals on 1030 MHz and transmits coded pulse-train reply signals on 1090 MHz. It is capable of replying to Mode A (aircraft identification) and Mode C (altitude reporting) interrogations on a selective reply basis on any of 4,096 information code selections. When an optional panel-mounted EA-401A Encoding Altimeter (not part of a standard 300 Transponder system) is included in the avionic configuration, the transponder can provide altitude reporting in 100-foot increments between -1000 and +35,000 feet.

All Cessna 300 Transponder operating controls, with the exception of the optional altitude encoder's altimeter setting knob, are located on the front panel of the unit. The altimeter setting knob is located on the encoding altimeter. Functions of the operating controls are described in Figure 1.

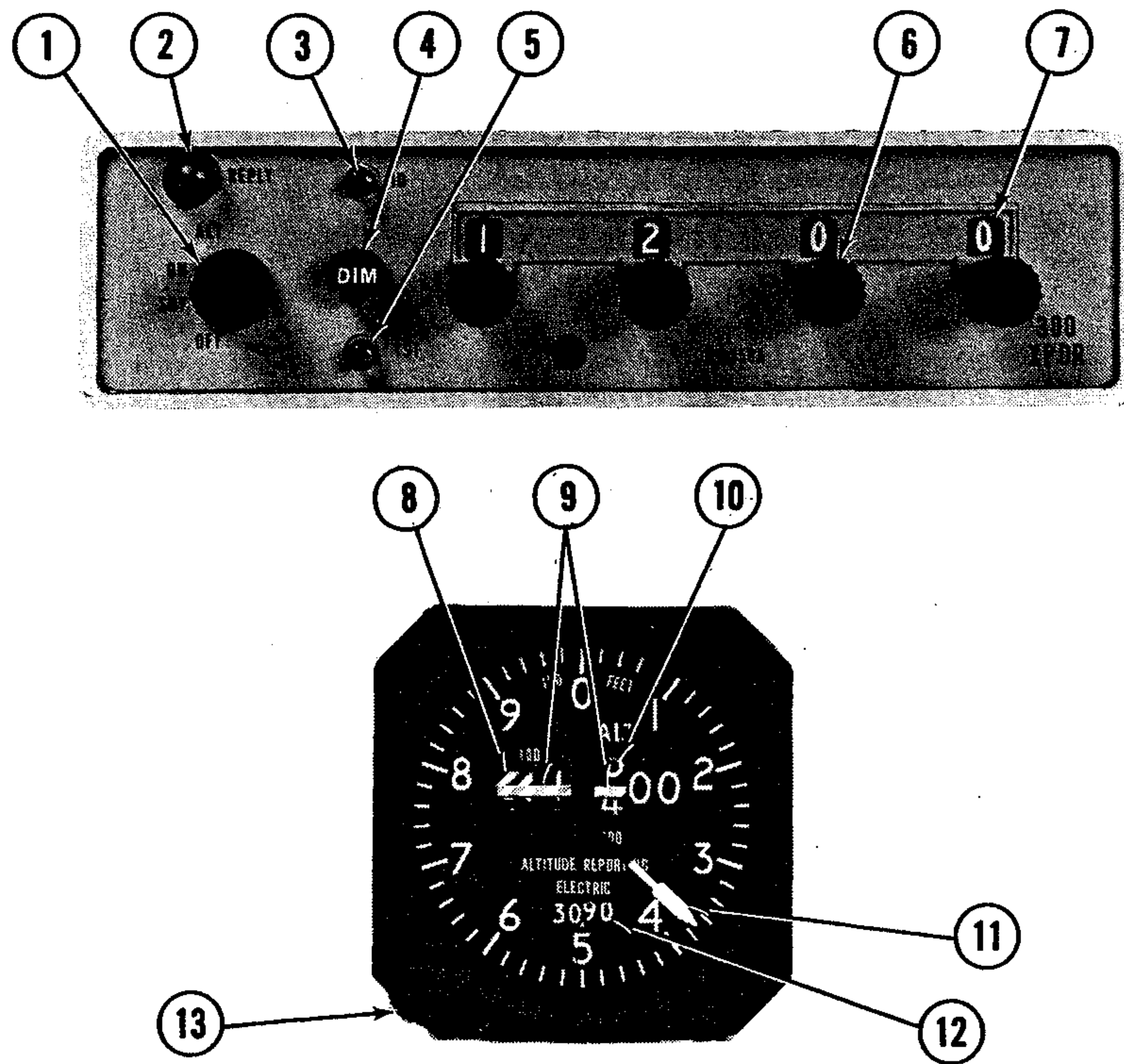

1. **FUNCTION SWITCH** - Controls application of power and selects transponder operating mode, as follows:
  - OFF - Turns set off.
  - SBY - Turns set on for equipment warm-up.
  - ON - Turns set on and enables transponder to transmit Mode A (aircraft identification) reply pulses.
  - ALT - Turns set on and enables transponder to transmit either Mode A (aircraft identification) reply pulses or Mode C (altitude reporting) pulses selected automatically by the interrogating signal.
  
2. **REPLY LAMP** - Lamp flashes to indicate transmission of reply pulses; glows steadily to indicate transmission of IDENT pulse or satisfactory self-test operation. (Reply Lamp will also glow steadily during initial warm-up period.)

Figure 1. Cessna 300 Transponder and Encoding Altimeter (Sheet 1 of 2)



3. **IDENT (ID) SWITCH** - When depressed, selects special pulse identifier to be transmitted with transponder reply to effect immediate identification of aircraft on ground controller's display. (Reply Lamp will glow steadily during duration of IDENT pulse transmission.)
4. **DIMMER (DIM) CONTROL** - Allows pilot to control brilliance of reply lamp.
5. **SELF-TEST (TST) SWITCH** -- When depressed, causes transponder to generate a self-interrogating signal to provide a check of transponder operation. (Reply Lamp will glow steadily to verify self test operation.)
6. **REPLY-CODE SELECTOR KNOBS (4)** - Select assigned Mode A reply code.
7. **REPLY-CODE INDICATORS (4)** - Display selected Mode A reply code.
8. **1000-FOOT DRUM TYPE INDICATOR** - Provides digital altitude readout in 1000-foot increments between -1000 feet and +35,000 feet. When altitude is below 10,000 feet, a diagonally striped flag appears in the 10,000 foot window.
9. **OFF INDICATOR WARNING FLAG** - Flag appears across altitude readout when power is removed from the altimeter to indicate that readout is not reliable.
10. **100-FOOT DRUM TYPE INDICATOR** - Provides digital altitude readout in 100-foot increments between 0 feet and 1000 feet.
11. **20-FOOT INDICATOR NEEDLE** - Indicates altitude in 20-foot increments between 0 feet and 1000 feet.
12. **ALTIMETER SETTING SCALE - DRUM TYPE** - Indicates selected altimeter setting in the range of 27.9 to 31.0 inches of mercury on the standard altimeter or 950 to 1050 millibars on the optional altimeter.
13. **ALTIMETER SETTING KNOB** - Dials in desired altimeter setting in the range of 27.9 to 31.0 inches of mercury on the standard altimeter or 950 to 1050 millibars on the optional altimeter.

Figure 1. Cessna 300 Transponder and Encoding Altimeter (Sheet 2 of 2)

## SECTION 2 LIMITATIONS

There is no change to the airplane limitations when this avionic equipment is installed.

## SECTION 3 EMERGENCY PROCEDURES

TO TRANSMIT AN EMERGENCY SIGNAL:

- (1) Function Switch -- ON.
- (2) Reply-Code Selector Knobs -- SELECT 7700 operating code.
- (3) ID Switch -- DEPRESS then RELEASE to effect immediate identification of aircraft on ground controller's display.

TO TRANSMIT A SIGNAL REPRESENTING LOSS OF ALL COMMUNICATIONS (WHEN IN A CONTROLLED ENVIRONMENT):

- (1) Function Switch -- ON.
- (2) Reply-Code Selector Knobs -- SELECT 7700 operating code for 1 minute; then SELECT 7600 operating code for 15 minutes and then REPEAT this procedure at same intervals for remainder of flight.
- (3) ID Switch -- DEPRESS then RELEASE at intervals to effect immediate identification of aircraft on ground controller's display.

## SECTION 4 NORMAL PROCEDURES

BEFORE TAKEOFF:

- (1) Function Switch -- SBY.

TO TRANSMIT MODE A (AIRCRAFT IDENTIFICATION) CODES IN FLIGHT:

- (1) Reply-Code Selector Knobs -- SELECT assigned code.

- (2) Function Switch -- ON.
- (3) DIM Control -- ADJUST light brilliance of reply lamp.

NOTE

During normal operation with function switch in ON position, reply lamp flashes indicating transponder replies to interrogations.

- (4) ID Button -- DEPRESS momentarily when instructed by ground controller to "squawk IDENT" (reply lamp will glow steadily, indicating IDENT operation).

TO TRANSMIT MODE C (ALTITUDE REPORTING) CODES IN FLIGHT:

- (1) Off Indicator Warning Flag -- VERIFY that flag is out of view on encoding altimeter.
- (2) Altitude Encoder Altimeter Setting Knob -- SET IN assigned local altimeter setting.
- (3) Reply-Code Selector Knobs -- SELECT assigned code.
- (4) Function Switch -- ALT.

NOTE

When directed by ground controller to "stop altitude squawk", turn Function Switch to ON for Mode A operation only.

NOTE

Pressure altitude is transmitted by the transponder for altitude squawk and conversion to indicated altitude is done in ATC computers. Altitude squawked will only agree with indicated altitude when the local altimeter setting in use by the ground controller is set in the encoding altimeter.

- (5) DIM Control -- ADJUST light brilliance of reply lamp.

TO SELF-TEST TRANSPONDER OPERATION:

- (1) Function Switch -- SBY and wait 30 seconds for equipment to warm-up.
- (2) Function Switch -- ON or ALT.

- (3) TST Button -- DEPRESS and HOLD (reply lamp should light with full brilliance regardless of DIM control setting).
- (4) TST Button -- Release for normal operation.

## SECTION 5 PERFORMANCE

There is no change to the airplane performance when this avionic equipment is installed. However, the installation of an externally mounted antenna or several related external antennas, will result in a minor reduction in cruise performance.

**SUPPLEMENT**

**CESSNA 300 TRANSPONDER**  
**(Type RT-359A)**  
**AND**  
**OPTIONAL ALTITUDE ENCODER (BLIND)**

**SECTION 1**  
**GENERAL**

The Cessna 300 Transponder (Type RT-359A), shown in Figure 1, is the airborne component of an Air Traffic Control Radar Beacon System (ATCRBS). The transponder enables the ATC ground controller to "see" and identify the aircraft, while in flight, on the control center's radarscope more readily.

The Cessna 300 Transponder system consists of a panel-mounted unit and an externally-mounted antenna. The transponder receives interrogation pulse signals on 1030 MHz and transmits pulse-train reply signals on 1090 MHz. The transponder is capable of replying to Mode A (aircraft identification) and also Mode C (altitude reporting) when coupled to an optional altitude encoder system. The transponder is capable of replying on both modes of interrogation on a selective reply basis on any of 4,096 information code selections. The optional altitude encoder system (not part of a standard 300 Transponder system) required for Mode C (altitude reporting) operation consists of a completely independent remote-mounted digitizer that is connected to the static system and supplies encoded altitude information to the transponder. When the altitude encoder system is coupled to the 300 Transponder system, altitude reporting capabilities are available in 100-foot increments between -1000 and +20,000 feet.

All Cessna 300 Transponder operating controls are located on the front panel of the unit. Functions of the operating controls are described in Figure 1.

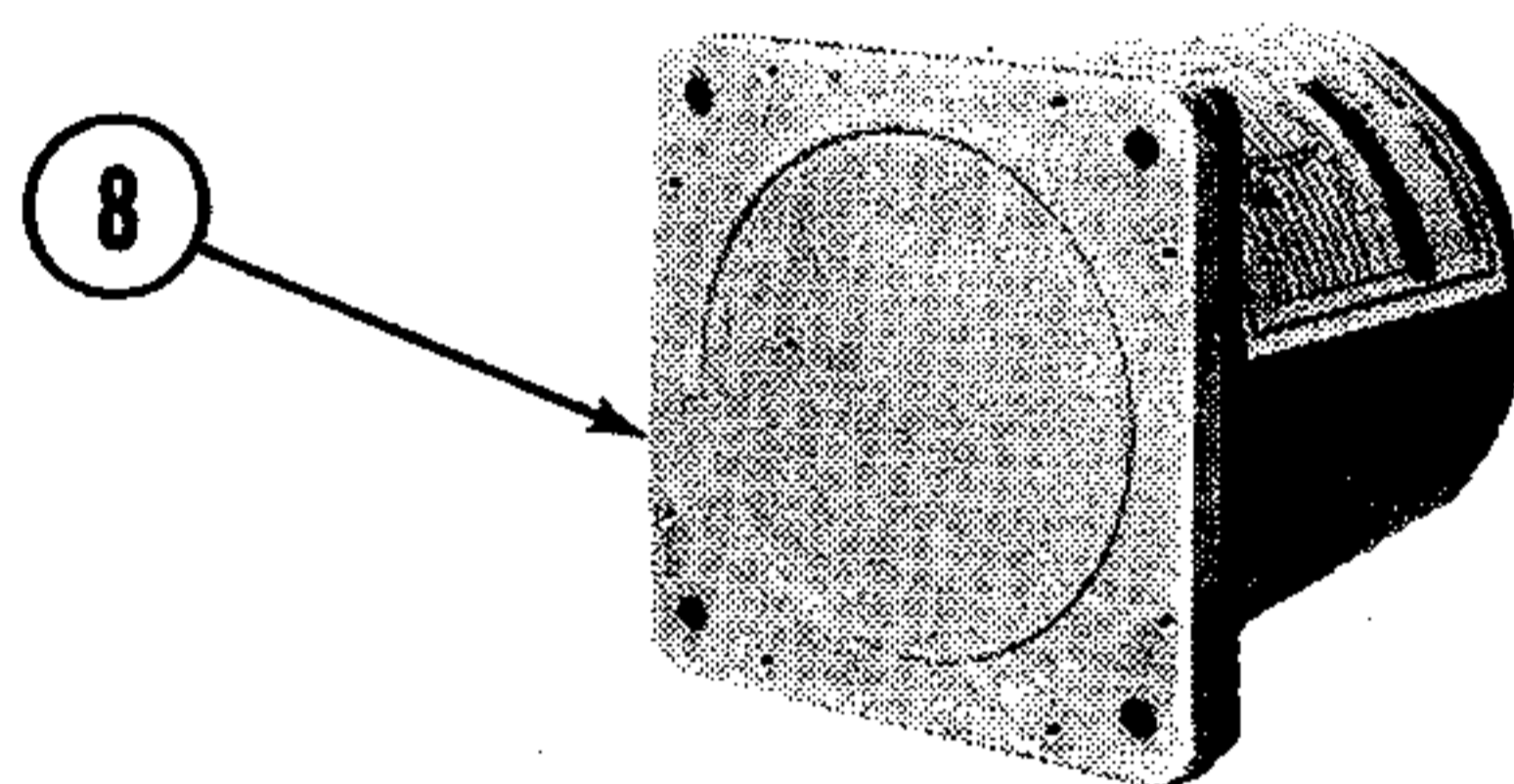
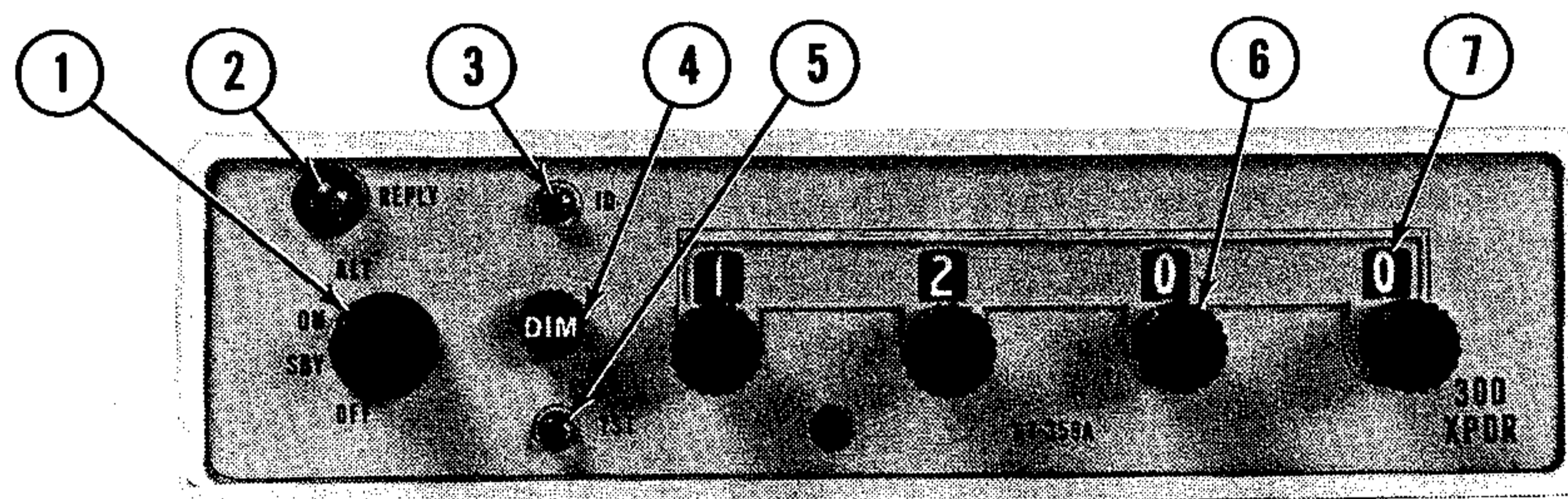

1. **FUNCTION SWITCH** - Controls application of power and selects transponder operating mode as follows:
  - OFF - Turns set off.
  - SBY - Turns set on for equipment warm-up or standby power.
  - ON - Turns set on and enables transponder to transmit Mode A (aircraft identification) reply pulses.
  - ALT - Turns set on and enables transponder to transmit either Mode A (aircraft identification) reply pulses or Mode C (altitude reporting) pulses selected automatically by the interrogating signal.
2. **REPLY LAMP** - Lamp flashes to indicate transmission of reply pulses; glows steadily to indicate transmission of IDENT pulse or satisfactory self-test operation. (Reply lamp will also glow steadily during initial warm-up period.)

Figure 1. Cessna 300 Transponder and Altitude Encoder (Blind)  
(Sheet 1 of 2)

3. **IDENT (ID) SWITCH** - When depressed, selects special pulse identifier to be transmitted with transponder reply to effect immediate identification of aircraft on ground controller's display. (Reply lamp will glow steadily during duration of IDENT pulse transmission.)
4. **DIMMER (DIM) CONTROL** - Allows pilot to control brilliance of reply lamp.
5. **SELF-TEST (TST) SWITCH** - When depressed, causes transponder to generate a self-interrogating signal to provide a check of transponder operation. (Reply lamp will glow steadily to verify self-test operation.)
6. **REPLY-CODE SELECTOR KNOBS (4)** - Select assigned Mode A reply code.
7. **REPLY-CODE INDICATORS (4)** - Display selected Mode A reply code.
8. **REMOTE-MOUNTED DIGITIZER** - Provides an altitude reporting code range of -1000 feet up to the airplane's maximum service ceiling.

Figure 1. Cessna 300 Transponder and Altitude Encoder (Blind)  
(Sheet 2 of 2)

## SECTION 2 LIMITATIONS

There is no change to the airplane limitations when this avionic equipment is installed. However, a placard labeled "ALTITUDE ENCODER EQUIPPED" must be installed near the altimeter.

## SECTION 3 EMERGENCY PROCEDURES

TO TRANSMIT AN EMERGENCY SIGNAL:

- (1) Function Switch -- ON.
- (2) Reply-Code Selector Knobs -- SELECT 7700 operating code.
- (3) ID Switch -- DEPRESS then RELEASE to effect immediate identification of aircraft on ground controller's display.

TO TRANSMIT A SIGNAL REPRESENTING LOSS OF ALL COMMUNICATIONS (WHEN IN A CONTROLLED ENVIRONMENT):

- (1) Function Switch -- ON.
- (2) Reply-Code Selector Knobs -- SELECT 7700 operating code for 1 minute; then SELECT 7600 operating code for 15 minutes and then REPEAT this procedure at same intervals for remainder of flight.
- (3) ID Switch -- DEPRESS then RELEASE at intervals to effect immediate identification of aircraft on ground controller's display.

## SECTION 4 NORMAL PROCEDURES

BEFORE TAKEOFF:

- (1) Function Switch -- SBY.

TO TRANSMIT MODE A (AIRCRAFT IDENTIFICATION) CODES IN FLIGHT:

- (1) Reply-Code Selector Knobs -- SELECT assigned code.



- (2) Function Switch -- ON.
- (3) DIM Control -- ADJUST light brilliance of reply lamp.

NOTE

During normal operation with function switch in ON position, reply lamp flashes indicating transponder replies to interrogations.

- (4) ID Button -- DEPRESS momentarily when instructed by ground controller to "squawk IDENT" (reply lamp will glow steadily, indicating IDENT operation).

TO TRANSMIT MODE C (ALTITUDE REPORTING) CODES IN FLIGHT:

- (1) Reply-Code Selector Knobs -- SELECT assigned code.
- (2) Function Switch -- ALT.

NOTE

When directed by ground controller to "stop altitude squawk", turn Function Switch to ON for Mode A operation only.

NOTE

Pressure altitude is transmitted by the transponder for altitude squawk and conversion to indicated altitude is done in ATC computers. Altitude squawked will only agree with indicated altitude when the local altimeter setting in use by the ground controller is set in the aircraft altimeter.

- (3) DIM Control -- ADJUST light brilliance of reply lamp.

TO SELF-TEST TRANSPONDER OPERATION:

- (1) Function Switch -- SBY and wait 30 seconds for equipment to warm-up.
- (2) Function Switch -- ON or ALT.
- (3) TST Button -- DEPRESS (reply lamp should light brightly regardless of DIM control setting).
- (4) TST Button -- Release for normal operation.

## SECTION 5 PERFORMANCE

There is no change to the airplane performance when this avionic equipment is installed. However, the installation of an externally mounted antenna or several related external antennas, will result in a minor reduction in cruise performance.

# SUPPLEMENT

## DME (TYPE 190)

### SECTION 1 GENERAL

The DME 190 (Distance Measuring Equipment) system consists of a panel mounted 200 channel UHF transmitter-receiver and an externally mounted antenna. The transceiver has a single selector knob that changes the DME's mode of operation to provide the pilot with: distance-to-station, time-to-station, or ground speed readouts. The DME is designed to operate in altitudes up to a maximum of 50,000 feet at ground speeds up to 250 knots and has a maximum slant range of 199.9 nautical miles.

The DME can be channeled independently or by a remote NAV set. When coupled with a remote NAV set, the MHz digits will be covered over by a remote (REM) flag and the DME will utilize the frequency set by the NAV set's channeling knobs. When the DME is not coupled with a remote NAV set, the DME will reflect the channel selected on the DME unit. The transmitter operates in the frequency range of 1041 to 1150 MHz and is paired with 108 to 117.95 MHz to provide automatic DME channeling. The receiver operates in the frequency range of 978 to 1213 MHz and is paired with 108 to 117.95 MHz to provide automatic DME channeling.

All operating controls for the DME are mounted on the front panel of the DME and are described in Figure 1.

### SECTION 2 LIMITATIONS

There is no change to the airplane limitations when this avionic equipment is installed.

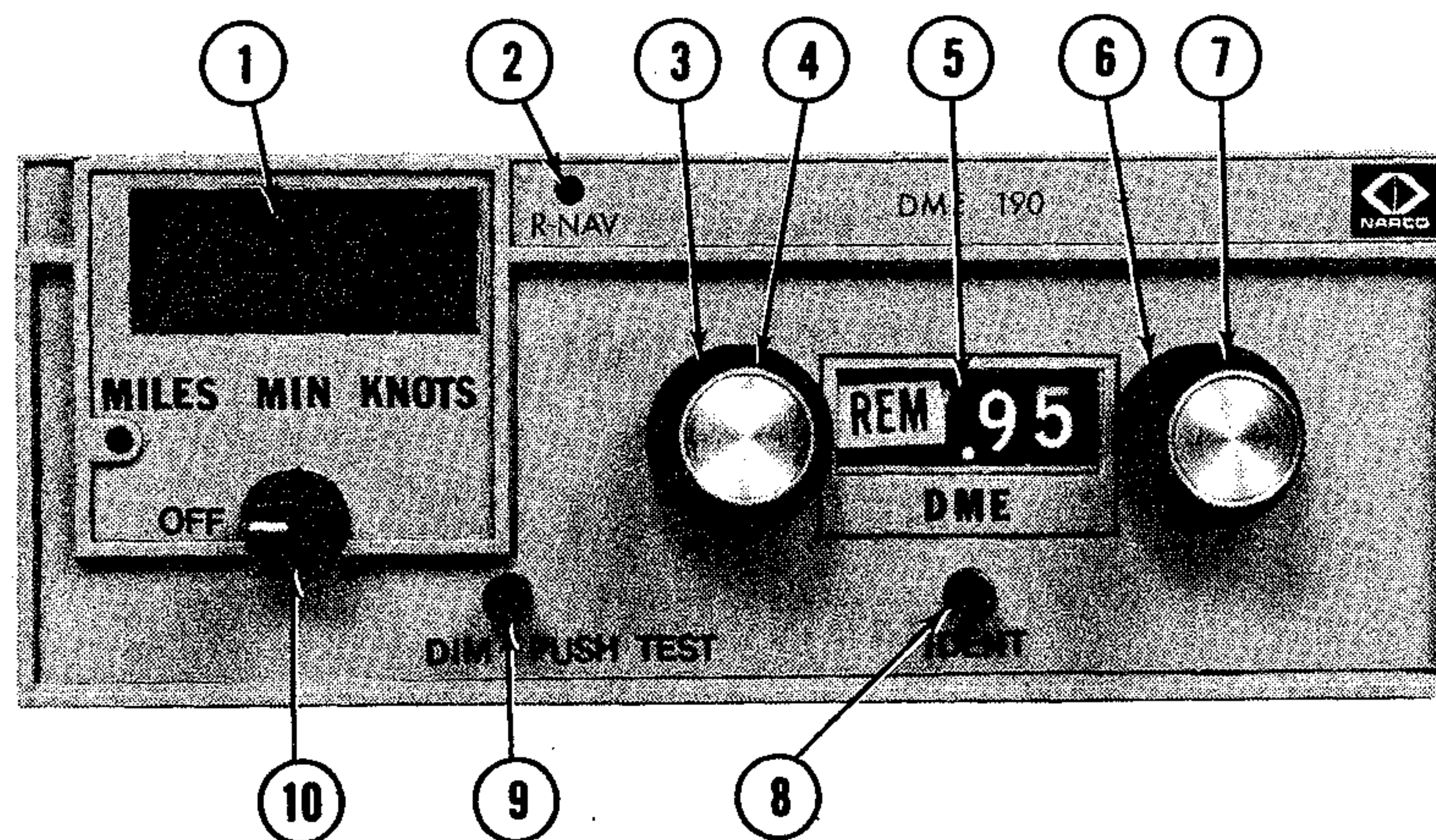

1. READOUT WINDOW - Displays function readout in nautical miles (distance-to-station), minutes (time-to-station) or knots (ground speed).
2. R-NAV INDICATOR LAMP - The green R-NAV indicator lamp is provided to indicate the DME is coupled to an R-NAV system. Since this DME is not factory installed with an R-NAV system on Cessna airplanes, the R-NAV indicator lamp should never be illuminated. However, if an R-NAV system is coupled to the DME, and when in R-NAV mode, the R-NAV lamp will light which indicates that the distance readout is the "way point" instead of the DME station. The DME can only give distance (MILES) in R-Nav mode.
3. REMOTE CHANNELING SELECTOR - This knob is held stationary by a stop when not coupled to a remote NAV receiver. When coupled to a remote NAV receiver, a stop in the selector is removed and the selector becomes a two position selector. In the first position, the DME will utilize the frequency set by the DME channeling knobs. In the second position, the MHz digits will utilize the frequency set by the NAV unit's channeling knobs.
4. WHOLE MEGAHERTZ SELECTOR KNOB - Selects operating frequency in 1-MHz steps between 108 and 117 MHz.
5. FREQUENCY INDICATOR - Shows operating frequency selected on the DME or displays remote (REM) flag to indicate DME is operating on a frequency selected by a remote NAV receiver.
6. FRACTIONAL MEGAHERTZ SELECTOR KNOB - Selects operating frequency in 50 kHz steps. This knob has two positions, one for the 0 and one for the 5.
7. FRACTIONAL MEGAHERTZ SELECTOR KNOB - Selects operating frequency in tenths of a Megahertz (0-9).

Figure 1. DME 190 Operating Controls (Sheet 1 of 2)

8. IDENT KNOB - Rotation of this control increases or decreases the volume of the received station's Ident signal. An erratic display, accompanied by the presence of two Ident signals, can result if the airplane is flying in an area where two stations using the same frequency are transmitting.
9. DIM/PUSH TEST KNOB -
  - DIM: Controls the brilliance of the readout lamp's segments. Rotate the control as desired for proper lamp illumination in the function window (The frequency window is dimmed by the aircraft's radio light dimming control).
  - PUSH TEST: This control is used to test the illumination of the readout lamps, with or without being tuned to a station. Press the control, a readout of 188 8 should be seen with the mode selector switch in the MIN or KNOTS position. The decimal point along with 188.8 will light in the MILES mode. When the control is released, and had the DME been channeled to a nearby station, the distance to that station will appear. If the station channeled was not in range, a "bar" readout will be seen (-.- or -- -).
10. MODE SELECTOR SWITCH -
  - OFF: Turns the DME OFF.
  - MILES: Allows a digital readout to appear in the window which represents slant range (in nautical miles) to or from the channeled station.
  - MIN: Allows a digital readout (in minutes) to appear in the window that it will take the airplane to travel the distance to the channeled station. This time is only accurate when flying directly TO the station and after the ground speed has stabilized.
  - KNOTS: Allows a digital readout (in knots) to appear in the window that is ground speed and is valid only after the stabilization time (approximately 2 minutes) has elapsed when flying directly TO or FROM the channeled station.

Figure 1. DME 190 Operating Controls (Sheet 2 of 2)

## SECTION 3 EMERGENCY PROCEDURES

There is no change to the airplane emergency procedures when this avionic equipment is installed.

## SECTION 4 NORMAL PROCEDURES

TO OPERATE:

1. Mode Selector Switch -- SELECT desired DME function.
2. Frequency Selector Knobs -- SELECT desired frequency and allow equipment to warm-up at least 2 minutes.

### NOTE

If frequency is set on remote NAV receiver, place remote channeling selector in the REM position.

3. PUSH TEST Control -- PUSH and observe reading of 188.8 in function window.
4. DIM Control -- ADJUST.
5. IDENT CONTROL -- ADJUST audio output in speaker.
6. Mode Selector Functions:
  - MILES Position -- Distance-to-Station is slant range in nautical miles.
  - MIN Position -- Time-to-Station when flying directly to station.
  - KNOTS Position -- Ground Speed in knots when flying directly to or from station.

### CAUTION

After the DME 190 has been turned OFF, do not turn it on again for 5 seconds to allow the protective circuits to reset.

## SECTION 5 PERFORMANCE

There is no change to the airplane performance when this avionic equipment is installed. However, the installation of an externally mounted antenna or several related external antennas, will result in a minor reduction in cruise performance.

# SUPPLEMENT

## HF TRANSCEIVER (TYPE PT10-A)

### SECTION 1 GENERAL

The PT10-A HF Transceiver, shown in Figure 1, is a 10-channel AM transmitter-receiver which operates in the frequency range of 2.0 to 18.0 Megahertz. The transceiver is automatically tuned to the operating frequency by a Channel Selector. The operating controls for the unit are mounted on the front panel of the transceiver. The system consists of a transceiver, antenna load box, fixed wire antenna and associated wiring.

The Channel Selector Knob determines the operating frequency of the transmitter and receiver. The frequencies of operation are shown on the frequency chart adjacent to the channel selector.

The VOLUME control incorporates the power switch for the transceiver. Clockwise rotation of the volume control turns the set on and increases the volume of audio.

The meter on the face of the transceiver indicates transmitter output.

The system utilizes the airplane microphone, headphone and speaker. When two or more radios are installed, a transmitter selector switch and a speaker-phone switch are provided.

### SECTION 2 LIMITATIONS

There is no change to the airplane limitations when this avionic equipment is installed.

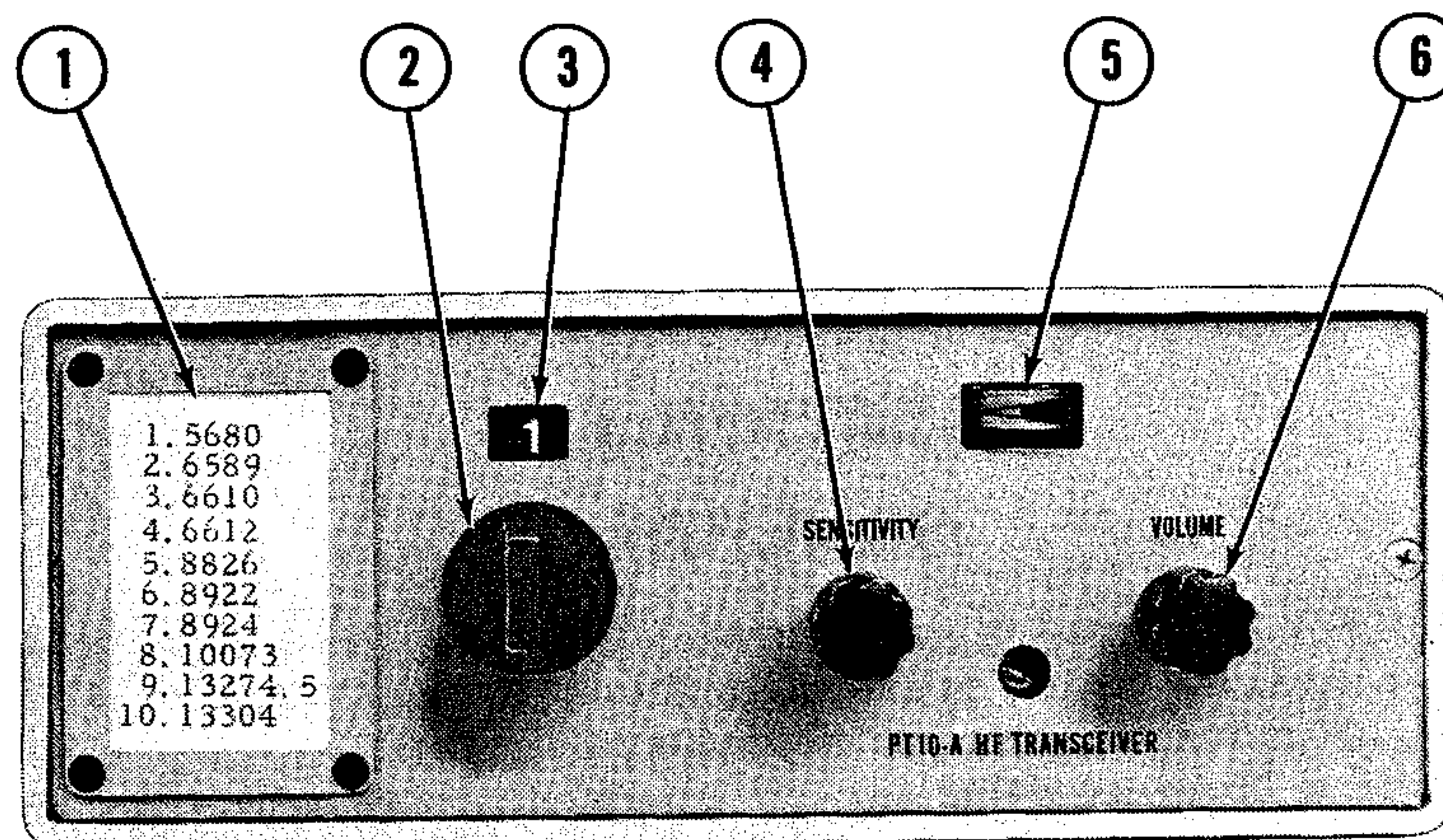

1. **FREQUENCY CHART** - Shows the frequency of the channel in use (frequencies shown may vary and are shown for reference purposes only).
2. **CHANNEL SELECTOR** - Selects channels 1 thru 10 as listed in the frequency chart.
3. **CHANNEL READOUT WINDOW** - Displays channel selected in frequency chart.
4. **SENSITIVITY CONTROL** - Controls the receiver sensitivity for audio gain.
5. **ANTENNA TUNING METER** - Indicates the energy flowing from the transmitter into the antenna. The optimum power transfer is indicated by the maximum meter reading.
6. **ON/OFF VOLUME CONTROL** - Turns complete set on and controls volume of audio.

Figure 1. HF Transceiver (Type PT10-A)



## SECTION 3 EMERGENCY PROCEDURES

There is no change to the airplane emergency procedures when this avionic equipment is installed.

## SECTION 4 NORMAL PROCEDURES

### COMMUNICATIONS TRANSCEIVER OPERATION:

1. XMTR SEL Switch -- SELECT transceiver (on audio control panel).
2. SPEAKER/PHONE (or AUTO) Switch -- SELECT desired mode (on audio control panel).
3. VOLUME Control -- ON (allow equipment to warm up and adjust audio to comfortable listening level).
4. Frequency Chart -- SELECT desired operating frequency.
5. Channel Selector -- DIAL in frequency selected in step 4.
6. SENSITIVITY Control -- ROTATE clockwise to maximum position.

#### NOTE

If receiver becomes overloaded by very strong signals, back off SENSITIVITY control until background noise is barely audible.

#### NOTE

The antenna tuning meter indicates the energy flowing from the airplane's transmitter into the antenna. The optimum power transfer is indicated by the maximum meter reading.

7. Mike Button:
  - a. To Transmit -- DEPRESS and SPEAK into microphone.

#### NOTE

Sidetone may be selected by placing the AUTO selector switch in either the SPEAKER or PHONE positions.

- b. To Receive -- RELEASE mike button.

## SECTION 5 PERFORMANCE

There is no change to the airplane performance when this avionic equipment is installed. However, the installation of an externally mounted antenna or several related external antennas, will result in a minor reduction in cruise performance.

# SUPPLEMENT

## SSB HF TRANSCEIVER (TYPE ASB-125)

### SECTION 1 GENERAL

The ASB-125 HF transceiver is an airborne, 10-channel, single sideband (SSB) radio with a compatible amplitude modulated (AM) transmitting-receiving system for long range voice communications in the 2 to 18 MHz frequency range. The system consists of a panel mounted receiver/exciter, a remote mounted power amplifier/power supply, an antenna coupler and an externally mounted, fixed wire, medium/high frequency antenna.

A channel selector knob determines the operating frequency of the transceiver which has predetermined crystals installed to provide the desired operating frequencies. A mode selector control is provided to supply the type of emission required for the channel, either sideband, AM or telephone for public correspondence. An audio knob, clarifier knob and squelch knob are provided to assist in audio operation during receive. In addition to the aforementioned controls, which are all located on the receiver/exciter, a meter is incorporated to provide antenna loading readouts.

The system utilizes the airplane microphone, headphone and speaker. When two or more radios are installed, a transmitter selector switch and a speaker-phone switch are provided.

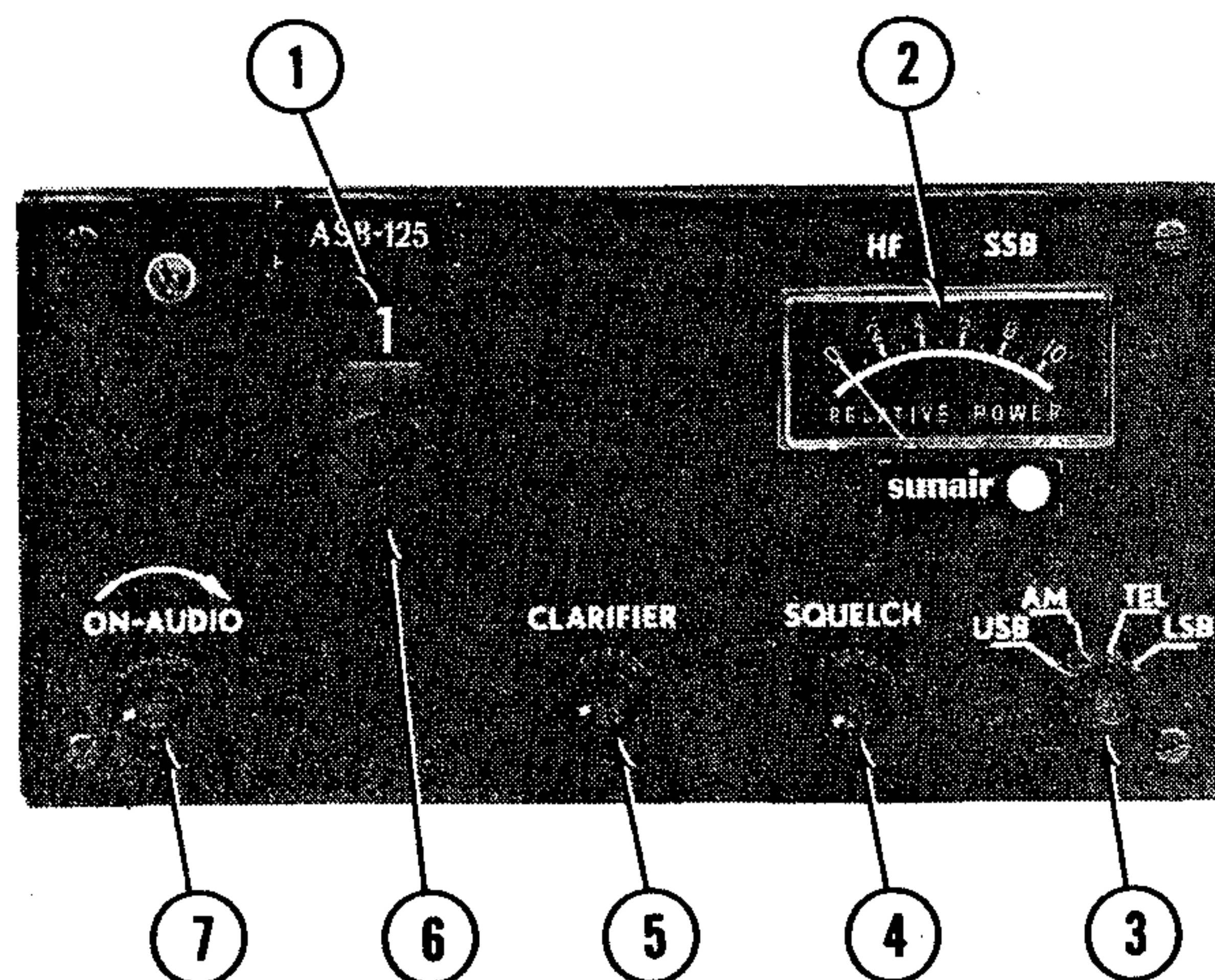

1. CHANNEL WINDOW - Displays selected channel.
2. RELATIVE POWER METER - Indicates relative radiated power of the power amplifier/antenna system.
3. MODE SELECTOR CONTROL - Selects one of the desired operating modes:
  - USB - Selects upper sideband operation for long range voice communications.
  - AM - Selects compatible AM operation and full AM reception.
  - TEL - Selects upper sideband with reduced carrier, used for public correspondence telephone and ship-to-shore.
  - LSB - (Optional) Selects lower sideband operation (not legal in U.S., Canada and most other countries).
4. SQUELCH CONTROL - Used to adjust signal threshold necessary to activate receiver audio. Clockwise rotation increases background noise (decreases squelch action); counterclockwise rotation decreases background noise.
5. CLARIFIER CONTROL - Used to "clarify" single sideband speech during receive while in USB mode only.
6. CHANNEL SELECTOR CONTROL - Selects desired channel. Also selects AM mode if channel frequency is 2003 kHz, 2182 kHz or 2638 kHz.
7. ON - AUDIO CONTROL - Turns set ON and controls receiver audio gain.

Figure 1. SSB HF Transceiver Operating Controls

## SECTION 2 LIMITATIONS

There is no change to the airplane limitations when this avionic equipment is installed. However, the pilot should be aware of the two following radio limitations:

1. For sideband operation in the United States, Canada and various other countries, only the upper sideband may be used. Use of lower sideband is prohibited.
2. Only AM transmissions are permitted on frequencies 2003 kHz, 2182 kHz and 2638 kHz. The selection of these channels will automatically select the AM mode of transmission.

## SECTION 3 EMERGENCY PROCEDURES

There is no change to the airplane emergency procedures when this avionic equipment is installed.

## SECTION 4 NORMAL PROCEDURES

### COMMUNICATIONS TRANSCEIVER OPERATION:

1. XMTR SEL Switch -- SELECT transceiver (on audio control panel).
2. SPEAKER/PHONE (or AUTO) Switch -- SELECT desired mode (on audio control panel).
3. ON-AUDIO Control -- ON (allow equipment to warm up for 5 minutes for sideband or one minute for AM operation and adjust audio to comfortable listening level).
4. Channel Selector Control -- SELECT desired frequency.
5. Mode Selector Control -- SELECT operating mode.
6. Squelch Control -- ADJUST the audio gain counterclockwise for normal noise output, then slowly adjust clockwise until the receiver is silent.
7. Clarifier Control -- ADJUST when upper single sideband RF signal is being received for maximum clarity.

8. Mike Button:  
a. To Transmit -- DEPRESS and SPEAK into microphone.

NOTE

Sidetone may be selected by placing the AUTO selector switch in either the SPEAKER or PHONE positions.

- b. To Receive -- RELEASE mike button.

NOTE

Voice communications are not available in the LSB mode.

NOTE

Lower sideband (LSB) mode is not legal in the U.S., Canada, and most other countries.

## SECTION 5 PERFORMANCE

There is no change to the airplane performance when this avionic equipment is installed. However, the installation of an externally mounted antenna or several related external antennas, will result in a minor reduction in cruise performance.

## SUPPLEMENT

# CESSNA 400 NAV/COM (720-Channel - Type RT-485A)

## SECTION 1 GENERAL

The Cessna 400 Nav/Com (Type RT-485A), shown in Figure 1, consists of a panel-mounted receiver-transmitter and a single or dual-pointer remote 300 or 400 Series course deviation indicator.

The set includes a 720-channel VHF communications receiver-transmitter and a 200-channel VHF navigation receiver, both of which may be operated simultaneously. The communications receiver-transmitter receives and transmits signals between 118.000 and 135.975 MHz in 25-kHz steps. The navigation receiver receives omni and localizer signals between 108.00 and 117.95 MHz in 50 kHz steps. The circuits required to interpret the omni and localizer signals are located in the course deviation indicator. Microprocessor frequency management provides storage for 3 preset NAV and 3 preset COM frequencies in MEMORY. A "keep-alive" voltage prevents loss of the preset frequencies when the Nav/Com is turned off. Both the communications and navigation operating frequencies are digitally displayed by incandescent readouts on the front panel of the Nav/Com.

A DME receiver-transmitter or a glide slope receiver, or both, may be interconnected with the Nav/Com set for automatic selection of the associated DME or glide slope frequency. When a VOR frequency is selected on the Nav/Com, the associated VORTAC or VOR-DME station frequency will also be selected automatically; likewise, if a localizer frequency is selected, the associated glide slope frequency will be selected automatically.

The 400 Nav/Com may be installed with either 300 or 400 Series course deviation indicators. The 400 Series Nav/Com indicators incorporate Automatic Radial Centering and Course Datum as standard features. The 300 Series course deviation indicators do not incorporate Course Datum but are offered with, or without, Automatic Radial Centering.

Both the 300 and 400 Series course deviation indicators include either a single-pointer and related NAV flag for VOR/LOC indication only, or dual

pointers and related NAV and GS flags for both VOR/LOC and glide slope indications. Both types of indicators incorporate a back-course lamp (BC) which lights when back course (reversed sense) operation is selected. Indicators with Automatic Radial Centering will, when selected, automatically indicate the bearing TO or FROM the VOR station.

All controls for the Nav/Com, except the omni bearing selector (OBS) knob or automatic radial centering (ARC) knob, which is located on the course deviation indicator, are mounted on the front panel of the receiver-transmitter. In addition, when two or more radios are installed, aircraft mounted transmitter selector and speaker/phone switches are provided.

## **SECTION 2**

### **LIMITATIONS**

There is no change to the airplane limitations when this avionic equipment is installed. However, the pilot should be aware that on many Cessna airplanes equipped with the windshield mounted glide slope antenna, pilots should avoid use of  $2700 \pm 100$  RPM on airplanes equipped with a two-bladed propeller or  $1800 \pm 100$  RPM on airplanes equipped with a three-bladed propeller during ILS approaches to avoid oscillations of the glide slope deviation pointer caused by propeller interference.

## **SECTION 3**

### **EMERGENCY PROCEDURES**

There is no change to the airplane emergency procedures when this avionic equipment is installed. However, if the frequency readouts fail, the frequency controls should not be moved due to the difficulty of obtaining a known frequency under this condition. The radio will remain operational on the last frequency selected, and the preset frequencies in MEMORY may be selected by pressing the appropriate MEMORY pushbutton.



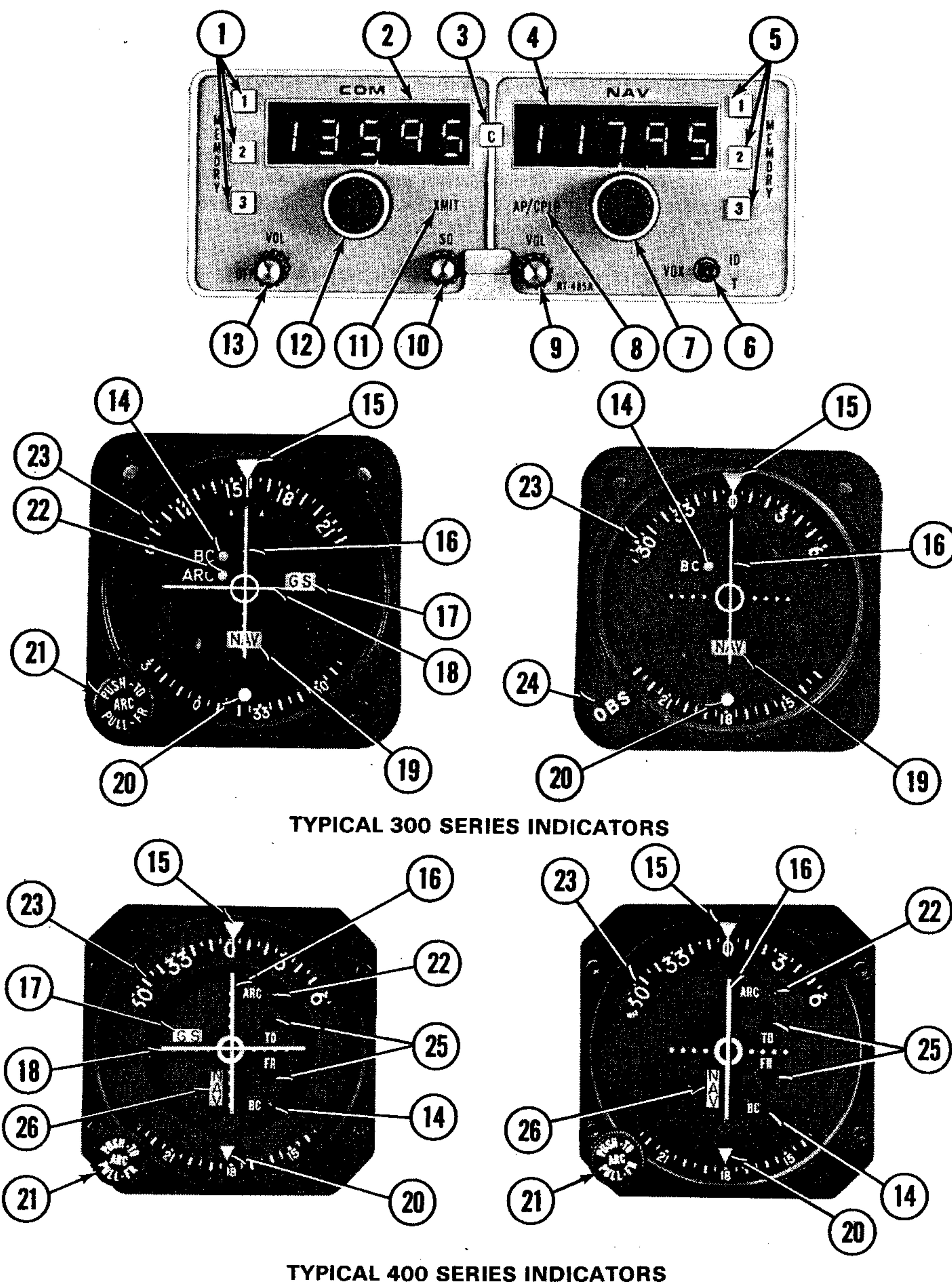

Figure 1. Cessna 400 Nav/Com (Type RT-485A), Operating Controls and Indicators (Sheet 1 of 4)

1. **COM MEMORY 1, 2 & 3 PUSHBUTTONS** - When a COM MEMORY pushbutton is pressed, the preset selected frequency will appear in the COM frequency window for use as the selected operating frequency. Each pushbutton will illuminate white when pressed and the light will go out on the previously selected pushbutton. Three preset frequencies may be stored in MEMORY and selected as desired, by merely pressing the appropriate COM MEMORY pushbutton to recall the desired operating frequency. If electrical power to the set's "keep-alive" circuit has not been interrupted, upon turn-on, the set will automatically recall the last COM MEMORY frequency selected by the MEMORY pushbutton. If electrical power is removed from the set's "keep-alive" circuit (such as radio removal or battery replacement) for more than 15 seconds, upon turn-on, the COM MEMORY circuits will have to be reset and COM 1 MEMORY will automatically be selected with the lowest operating frequency (118.000 MHz) selected.
2. **COMMUNICATION OPERATING FREQUENCY READOUT** - Indicates COM frequency in use. Third decimal place not shown.
3. **CYCLE BUTTON (C)** - Selects last illuminated decimal place on COM frequency in use. If last decimal place is 2 or 7, pressing C pushbutton changes number to 5 or 0, respectively. If last decimal place is 5 or 0, pressing C pushbutton changes number to 7 or 2, respectively. When the last illuminated digit on the set is 2 or 7, the third digit on the set (not shown) will always be 5. When the last illuminated digit on the set is 0 or 5, the third digit on the set (not shown) will always be 0. Also provides test function by holding C pushbutton pressed for more than 1.7 seconds. This lights each COM and NAV MEMORY pushbutton in turn, and displays the corresponding preset frequency in MEMORY.
4. **NAVIGATION OPERATING FREQUENCY READOUT** - Indicates NAV frequency in use.
5. **NAV MEMORY 1, 2 & 3 PUSHBUTTONS** - When a NAV MEMORY pushbutton is pressed, the preset selected frequency will appear in the NAV frequency window for use as the selected operating frequency. Each pushbutton will illuminate white when pressed and the light will go out on the previously selected pushbutton. Three preset frequencies may be stored in MEMORY and selected as desired, by merely pressing the appropriate NAV MEMORY pushbutton to recall the desired operating frequency. If electrical power to the set's "keep-alive" circuit has not been interrupted, upon turn-on, the set will automatically recall the last NAV MEMORY frequency selected by the MEMORY pushbutton. If electrical power is removed from the set's "keep-alive" circuit (such as radio removal or battery replacement) for more than 15 seconds, upon turn-on, the NAV MEMORY circuits will have to be reset and NAV 1 MEMORY will automatically be selected with the lowest operating frequency (108.000 MHz) selected.
6. **ID-VOX-T SWITCH** - In ID position, station identifier signal is audible; in VOX (Voice) position, identifier signal is suppressed; in T (Momentary On) position, the self-test function is selected, and the AP/CPLD annunciator illuminates amber and the XMIT annunciator illuminates green.
7. **NAVIGATION RECEIVER FREQUENCY SELECTORS** - Outer knob changes NAV frequency in 1-MHz steps between 108 and 117 MHz; inner knob changes NAV frequency in .05-MHz steps between .00 and .95 MHz; simultaneously selects paired glide slope frequency and DME channel.

Figure 1. Cessna 400 Nav/Com (Type RT-485A), Operating Controls and Indicators (Sheet 2 of 4)

8. **AUTOPILOT COUPLED ANNUNCIATOR (AP/CPLD)** - Illuminates amber when a 400B or 400B IFCS autopilot is coupled to NAV VOR/LOC converter output (non-operational with 200A, 300A, 400, 400A and 400A IFCS autopilots).
9. **NAV VOLUME CONTROL (VOL)** - Adjusts volume of navigation receiver audio.
10. **SQUELCH CONTROL** - Used to adjust signal threshold necessary to activate COM receiver audio. Clockwise rotation increases background noise (decreases squelch action); counterclockwise rotation decreases background noise.
11. **TRANSMIT ANNUNCIATOR (XMIT)** - Illuminates green when transmitter output is normal while mike is keyed.
12. **COMMUNICATION RECEIVER FREQUENCY SELECTORS** - Outer knob changes COM frequency in 1-MHz steps between 118 and 135 MHz; inner knob changes COM frequency in .05 MHz steps between .025 and .975 MHz or between .000 and .950 MHz depending on selection of C button.
13. **COM OFF-VOLUME CONTROL (OFF-VOL)** - Combination ON/OFF switch and volume control; turns on Nav/Com set and controls volume of COM receiver audio.
14. **BACK-COURSE LAMP (BC)** - Amber light illuminates when an autopilot with reverse sense feature is installed and the reverse sense switch or autopilot's back-course function is engaged and receiver is tuned to a localizer frequency; indicates course deviation pointer is reversed.
15. **COURSE INDEX** - Indicates selected VOR COURSE.
16. **COURSE DEVIATION POINTER** - Indicates course deviation from selected omni course or localizer centerline.
17. **GLIDE SLOPE "GS" FLAG** - When visible, red GS flag indicates unreliable glide slope signal or improperly operating equipment. Flag disappears when a reliable glide slope signal is being received.
18. **GLIDE SLOPE DEVIATION POINTER** - Indicates deviation from ILS glide slope.
19. **NAV/TO-FROM INDICATOR** - Operates only with a VOR or localizer signal. Red NAV position (Flag) indicates unusable signal. With usable VOR signal, indicates whether selected VOR course is TO or FROM station. With usable localizer signal, shows TO.
20. **RECIPROCAL COURSE INDEX** - Indicates reciprocal of selected VOR course.
21. **AUTOMATIC RADIAL CENTERING (ARC) PUSH-TO/PULL-FR SELECTOR** - In center detent, functions as conventional OBS. Pushed to inner (Momentary On) position, rotates OBS course card to center course deviation pointer with a TO flag, then returns to conventional OBS selection. Pulled to outer detent, continuously drives OBS course card to indicate bearing from VOR station, keeping

**Figure 1. Cessna 400 Nav/Com (Type RT-485A), Operating Controls and Indicators (Sheet 3 of 4)**

course deviation pointer centered, with a FROM flag. ARC function will not operate on localizer frequencies.

NOTE

Engaging either Automatic Radial Centering (ARC) functions will alter the airplane's course anytime the autopilot is engaged and coupled to any frequency other than a localizer frequency.

22. AUTOMATIC RADIAL CENTERING (ARC) LAMP - Amber light illuminates when Automatic Radial Centering is in use.
23. COURSE CARD - Indicates selected VOR course under course index.
24. OMNI BEARING SELECTOR (OBS) - Rotates course card to select desired course.
25. TO/FROM INDICATOR (TO/FR) - Operates only with a usable VOR or localizer signal. When white flag is in view, indicates whether selected course is TO or FROM station. With usable localizer signal, shows TO.
26. NAV INDICATOR FLAG - When in view, red NAV position (Flag) indicates the selected VOR or localizer signal is unusable.

Figure 1. Cessna 400 Nav/Com (Type RT-485A), Operating Controls and Indicators (Sheet 4 of 4)

## SECTION 4

### NORMAL PROCEDURES

#### PRESETTING NAV/COM FREQUENCIES IN MEMORY:

1. COM OFF/VOL CONTROL -- TURN ON; adjust to desired audio level.
2. MEMORY 1 Pushbutton -- PRESS desired NAV or COM pushbutton 1 momentarily to alert the memory bank of a forthcoming frequency to be stored.
3. FREQUENCY SELECTORS -- MANUALLY ROTATE corresponding NAV or COM frequency selectors (press C pushbutton as required to select the desired third fractional COM digit) until the desired frequency is shown in the operating frequency readout window. The frequency displayed will be automatically transferred into MEMORY 1.

#### NOTE

Do not press the C pushbutton more than about 2 seconds while selecting fractional frequencies or you will activate the MEMORY test function.

4. MEMORY 2 and 3 Pushbuttons -- REPEAT STEPS 2 and 3 using next desired NAV or COM MEMORY to be stored. Up to 3 NAV and 3 COM frequencies may be stored for automatic recall frequency selection.

#### NOTE

The operating frequency set in the selected MEMORY position will automatically be changed in the MEMORY bank any time the operating frequency is manually changed.

#### COMMUNICATION RECEIVER-TRANSMITTER OPERATION:

1. COM OFF/VOL Control -- TURN ON.
2. XMTR SEL Switch -- SET to desired 400 Nav/Com (on audio control panel).
3. SPEAKER/PHONE (or AUTO) Switch -- SET to desired mode (on audio control panel).
4. COM Frequency Selection -- SELECT desired operating frequency by either pressing a COM MEMORY 1, 2 or 3 pushbutton to recall a preset frequency, or by manually selecting the desired operating frequency using the COM frequency selectors and C pushbutton.

5. VOL Control -- ADJUST to desired audio level.
6. SQ Control -- ROTATE counterclockwise to decrease background noise as required.
7. Mike Button:
  - a. To Transmit -- DEPRESS and SPEAK into microphone.

NOTE

Sidetone may be selected by placing the AUTO selector switch (on audio control panel) in either the SPEAKER or PHONE position. Adjustment of sidetone may be accomplished by adjusting the sidetone pot located inside the audio control panel.

- b. XMIT Annunciator Light -- CHECK ON (green light illuminated).
- c. To Receive -- RELEASE mike button.

NAVIGATION OPERATION:

1. COM OFF/VOL Control -- TURN ON; adjust to desired audio level.
2. SPEAKER/PHONE (or AUTO) Switch -- SET to desired mode (on audio control panel).
3. NAV Frequency Selection -- SELECT desired operating frequency by either pressing a NAV MEMORY 1, 2 or 3 pushbutton to recall a preset frequency, or by using NAV frequency selectors.
4. NAV VOL Control -- ADJUST to desired audio level.
5. ID-VOX-T Switch:
  - a. To Identify Station -- SET to ID to hear navigation station identifier signal.
  - b. To Filter Out Station Identifier Signal -- SET to VOX to include filter in audio circuit.
6. ARC PUSH-TO/PULL-FROM Knob (If Applicable):
  - a. To Use As Conventional OBS -- PLACE in center detent and select desired course.
  - b. To Obtain Bearing TO VOR Station -- PUSH (ARC/PUSH-TO) knob to inner (Momentary On) position.

NOTE

ARC lamp will illuminate amber while the course card is moving to center the course deviation pointer. After alignment has been achieved to reflect bearing TO VOR, automatic radial centering will automatically shut down, causing the ARC lamp to go out and the ARC knob to return to the center detent position and function as a normal OBS.

- c. To obtain Continuous Bearing FROM VOR Station -- PULL (ARC/PULL-FR) knob to outer detent.

**NOTE**

ARC lamp will illuminate amber, OBS course card will turn to center the course deviation pointer with a FROM flag to indicate bearing from VOR station. This system will continually drive to present the VOR radial the aircraft is on until manually returned to the center detent by the pilot.

7. AP/CPLD Annunciator -- CHECK ON (if 400B Autopilot or 400B IFCS is engaged), amber light illuminated.

**NOTE**

The AP/CPLD annunciator light is only operational with a 400B Autopilot or 400B IFCS installation.

**VOR SELF-TEST OPERATION:**

1. COM OFF/VOL Control -- TURN ON.
2. NAV Frequency Selector Switches -- SELECT usable VOR station signal.
3. OBS Knob -- SET for 0° course at course index; course deviation pointer centers or deflects left or right, depending on bearing of signal; NAV/TO-FROM indicator shows TO or FROM.
4. ID/VOX/T Switch -- PRESS to T and HOLD at T; course deviation pointer centers, NAV/TO-FROM indicator shows FROM and AP/CPLD and XMIT annunciators light.
5. OBS Knob -- TURN to displace course approximately 10° to either side of 0° (while holding ID/VOX/T to T). Course deviation pointer deflects full scale in direction corresponding to course displacement. NAV/TO-FROM indicator shows FROM.
6. ID/VOX/T Switch -- RELEASE for normal operation.

**NOTE**

This test does not fulfill the requirements of FAR 91.25.

**MEMORY TEST OPERATION:**

1. C Pushbutton -- PUSH for about 2 seconds. Each COM and NAV

MEMORY pushbutton (1, 2 & 3) will illuminate white, in turn, with the corresponding preset frequency displayed.

**NOTE**

If the "keep-alive" circuit has not been interrupted, the MEMORY test will always start with the last COM MEMORY selected and cycle through the remaining COM and NAV preset frequencies. The MEMORY test will always stop on the last selected COM and NAV preset frequencies.

## **SECTION 5**

### **PERFORMANCE**

There is no change to the airplane performance when this avionic equipment is installed. However, the installation of an externally mounted antenna or several related external antennas, will result in a minor reduction in cruise performance.



## SUPPLEMENT

### CESSNA 400 NAV/COM (Type RT-485A)

WITH

### CESSNA 400 AREA NAVIGATION SYSTEM (Type RN-478A)

#### SECTION 1 GENERAL

The Cessna 400 Nav/Com (Type RT-485A) Set with Cessna 400 Area Navigation (RNAV-Type RN-478A) consists of a RT-485A Nav/Com, a R-476A DME system, a RN-478A Area Navigation Computer and a Course Deviation Indicator with, or without, the optional Automatic Radial Centering (ARC) feature. The RN-478A includes circuits which combine the VOR navigation information with distance information from the R-476A DME system to provide data for area navigation. Operating information for the communication set and for VOR/localizer navigation is presented in this supplement. Operating information for area navigation and for DME is presented in separate supplements. Microprocessor frequency management provides storage for 3 preset NAV and 3 preset COM frequencies in MEMORY. A "keep-alive" voltage prevents loss of the preset frequencies when the NAV/COM Switch, Avionics Power Switch, or Master Switch is turned OFF.

The RT-485A Receiver-Transmitter includes a 720-channel VHF communication receiver-transmitter which receives and transmits signals between 118.000 MHz and 135.975 MHz in 25-kHz steps. It also includes a 200-channel VHF navigation receiver which receives VOR and localizer signals between 108.00 MHz and 117.95 MHz in 50-kHz steps. The communication receiver-transmitter and the navigation receiver can be operated simultaneously.

The VOR or localizer signal from the navigation receiver is applied to

the converter circuits in the RN-478A Area Navigation Computer. The converter processes the received navigation signal to provide omni bearing or localizer information for display by the course indicator.

### CAUTION

If the RNAV set is removed from the airplane or becomes inoperative, the associated VHF navigation indicator will be inoperative.

The course indicator includes a Course Deviation Indicator (CDI), an Omni Bearing Selector (OBS) or Automatic Radial Centering (ARC) knob, and OFF (or NAV)/To-From Indicator Flags. It also includes an RNAV lamp (RN) which lights when area navigation operation is selected, and a back-course lamp (BC) which lights when back-course operation is selected. The IN-442AR is offered as the standard Course Deviation Indicator and an optional IN-1048AC Course Deviation Indicator is also offered when Automatic Radial Centering (ARC) is desired. When the optional IN-1048AC Course Deviation Indicator is installed, an Automatic Radial Centering lamp (ARC) is incorporated in the CDI to alert the pilot that the Automatic Radial Centering feature has been selected.

All operating controls and indicators for the Cessna 400 Nav/Com are included on the front panel of the RT-485A Receiver-Transmitter and the associated Course Deviation Indicator. These controls and indicators are shown and described in Figure 1. Operating controls for the RN-478A Area Navigation Computer, which are used for area navigation, and operating controls for the associated Type R-476A DME are shown in the appropriate supplements in this manual.

## SECTION 2 LIMITATIONS

There is no change to the airplane limitations when this avionic equipment is installed. However, the pilot should be aware that on many Cessna airplanes equipped with the windshield mounted glide slope antenna, pilots should avoid use of  $2700 \pm 100$  RPM on airplanes equipped with a two-bladed propeller or  $1800 \pm 100$  RPM on airplanes equipped with a three-bladed propeller during ILS approaches to avoid oscillations of the glide slope deviation pointer caused by propeller interference.

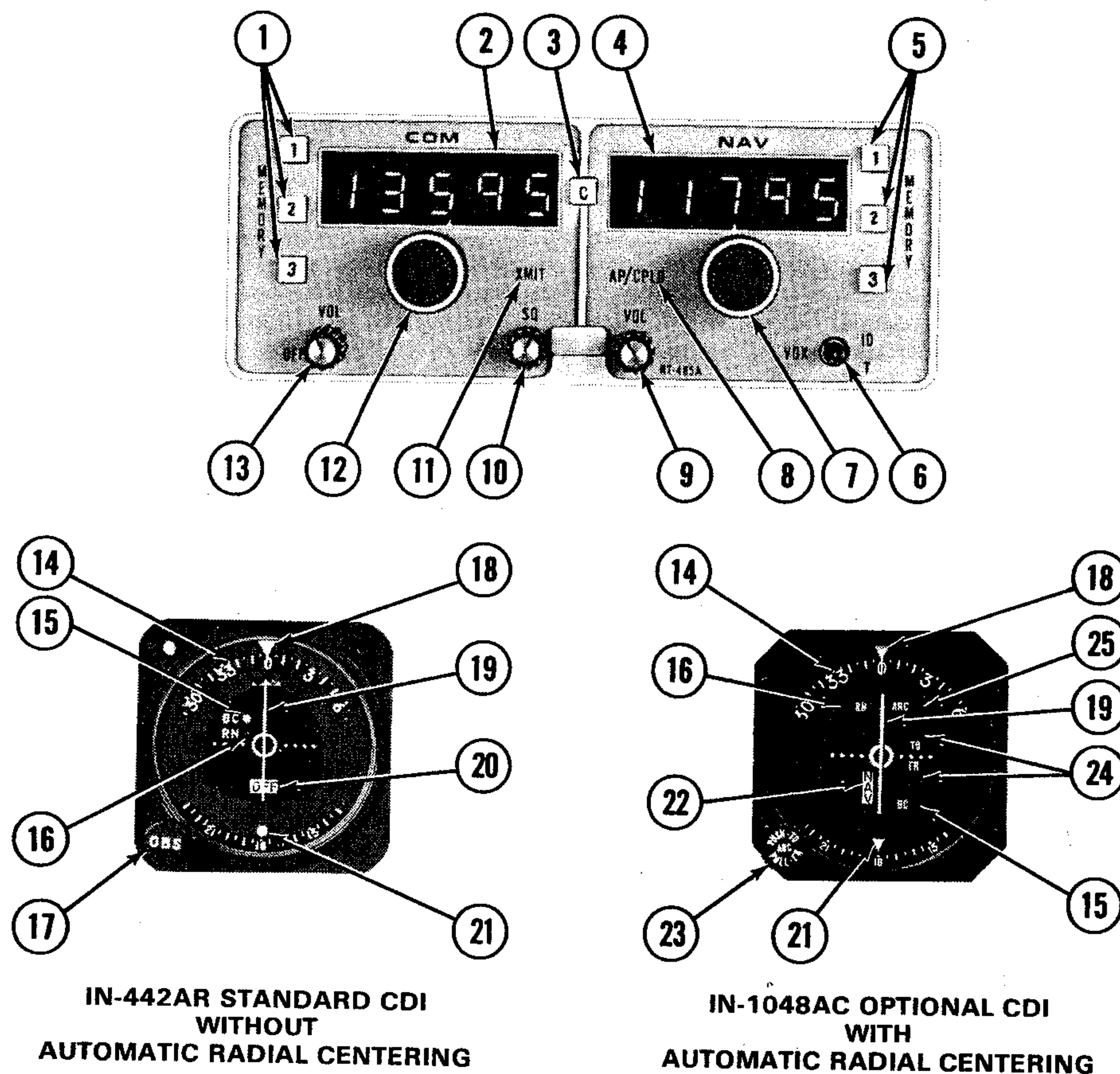

IN-442AR STANDARD CDI  
WITHOUT  
AUTOMATIC RADIAL CENTERING

IN-1048AC OPTIONAL CDI  
WITH  
AUTOMATIC RADIAL CENTERING

1. COMM MEMORY 1, 2 & 3 PUSHBUTTONS - When a COM MEMORY pushbutton is pressed, the preset selected frequency will appear in the COM frequency window for use as the selected operating frequency. Each pushbutton will illuminate white when pressed and the light will go out on the previously selected pushbutton. Three preset frequencies may be stored in MEMORY and selected as desired, by merely pressing the appropriate COM MEMORY pushbutton to recall the desired operating frequency. If electrical power to the set's "keep-alive" circuit has not been interrupted, upon turn-on, the set will automatically recall the last COM MEMORY frequency selected by the MEMORY pushbutton. If electrical power is removed from the set's "keep-alive" circuit (such as radio removal or battery replacement) for more than 15 seconds, upon turn-on, the COM MEMORY circuits will have to be reset and COM 1 MEMORY will automatically be selected with the lowest operating frequency (118.000 MHz) selected.

Figure 1. Cessna 400 Nav/Com Set, Operating Controls and Indicators  
(Sheet 1 of 4)

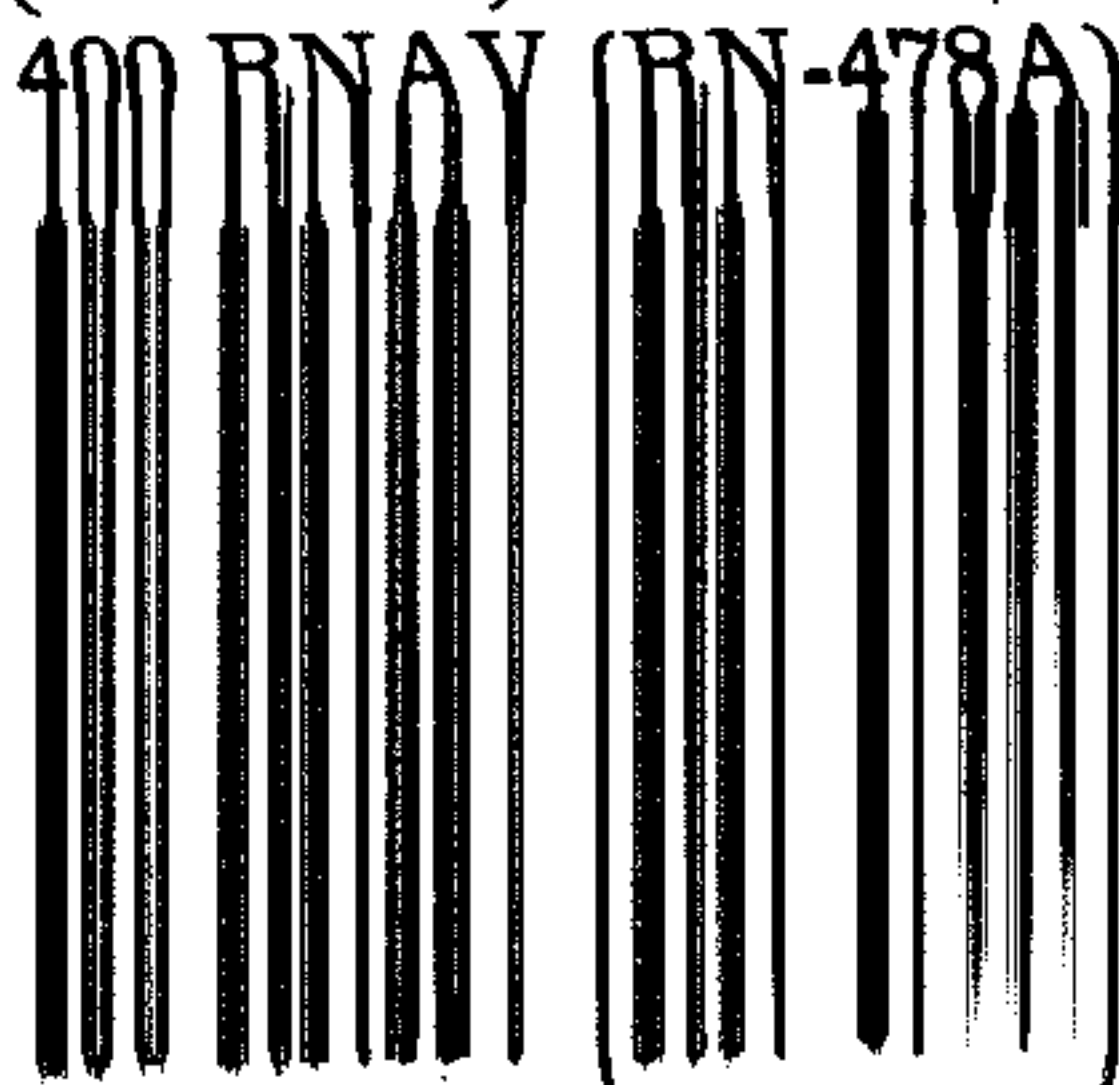

2. **COMMUNICATION OPERATING FREQUENCY READOUT** - Indicates COM frequency in use. Third decimal place not shown.
3. **CYCLE BUTTON (C)** - Selects last illuminated decimal place on COM frequency in use. If last decimal place is 2 or 7, pressing C pushbutton changes number to 5 or 0, respectively. If last decimal place is 5 or 0, pressing C pushbutton changes number to 7 or 2, respectively. When the last illuminated digit on the set is 2 or 7, the third digit on the set (not shown) will always be 5. When the last illuminated digit on the set is 0 or 5, the third digit on the set (not shown) will always be 0. Also provides test function by holding C pushbutton pressed for more than 1.7 seconds. This lights each COM and NAV MEMORY pushbutton in turn, and displays the corresponding preset frequency in MEMORY.
4. **NAVIGATION OPERATING FREQUENCY READOUT** - Indicates NAV frequency in use.
5. **NAV MEMORY 1, 2 & 3 PUSHBUTTONS** - When a NAV MEMORY pushbutton is pressed, the preset selected frequency will appear in the NAV frequency window for use as the selected operating frequency. Each pushbutton will illuminate white when pressed and the light will go out on the previously selected pushbutton. Three preset frequencies may be stored in MEMORY and selected as desired, by merely pressing the appropriate NAV MEMORY pushbutton to recall the desired operating frequency. If electrical power to the set's "keep-alive" circuit has not been interrupted, upon turn-on, the set will automatically recall the last NAV MEMORY frequency selected by the MEMORY pushbutton. If electrical power is removed from the set's "keep-alive" circuit (such as radio removal or battery replacement) for more than 15 seconds, upon turn-on, the NAV MEMORY circuits will have to be reset and NAV 1 MEMORY will automatically be selected with the lowest operating frequency (108.000 MHz) selected.
6. **ID-VOX-T SWITCH** - In ID position, station identifier signal is audible; in VOX (Voice) position, identifier signal is suppressed; in T (Momentary On) position, the self-test function is selected, and the AP/CPLD annunciator illuminates amber and the XMIT annunciator illuminates green.
7. **NAVIGATION RECEIVER FREQUENCY SELECTORS** - Outer knob changes NAV frequency in 1-MHz steps between 108 and 117 MHz; inner knob changes NAV frequency in .05-MHz steps between .00 and .95 MHz; simultaneously selects paired glide slope frequency and DME channel.
8. **AUTOPILOT COUPLED ANNUNCIATOR (AP/CPLD)** - Illuminates amber when a 400B or 400B IFCS autopilot is coupled to NAV VOR/LOC converter output (non-operational with 200A, 300A, 400A and 400A IFCS autopilots).
9. **NAV VOLUME CONTROL (VOL)** - Adjusts volume of navigation receiver audio.
10. **SQUELCH CONTROL** - Used to adjust signal threshold necessary to activate COM receiver audio. Clockwise rotation increases background noise (decreases squelch action); counterclockwise rotation decreases background noise
11. **TRANSMIT ANNUNCIATOR (XMIT)** - Illuminates green when transmitter output is normal while mike is keyed.

Figure 1. Cessna 400 Nav/Com Set, Operating Controls and Indicators  
(Sheet 2 of 4)

12. COMMUNICATION RECEIVER FREQUENCY SELECTORS - Outer knob changes COM frequency in 1-MHz steps between 118 and 135 MHz; inner knob changes COM frequency in .05 MHz steps between .025 and .975 MHz or between .000 and .950 MHz depending on setting of C button.
13. COM OFF-VOLUME CONTROL (OFF-VOL) - Combination ON/OFF switch and volume control; turns on Nav/Com set and controls volume of COM receiver audio.
14. COURSE CARD - Indicates selected VOR course under course index.
15. BACK-COURSE LAMP (BC) - Amber light illuminates when an autopilot with reverse sense feature is installed and the reverse sense switch or autopilot's back-course function is engaged and receiver is tuned to a localizer frequency; indicates course deviation pointer is reversed.
16. AREA NAV LAMP (RN) - When green light is illuminated, indicates that RNAV operation is selected.
17. OMNI BEARING SELECTOR (OBS) - Rotates course card (12) to select desired bearing to or from a VOR station or to a selected RNAV waypoint.
18. COURSE INDEX - Indicates selected VOR or RNAV course (bearing).
19. COURSE DEVIATION POINTER - Indicates course deviation from selected VOR or RNAV course or localizer centerline.
20. OFF/TO-FROM INDICATOR - Operates only with VOR or localizer signal. OFF position (flag) indicates unusable signal. With usable VOR signal, when OFF position disappears, indicates whether selected course is TO or FROM station or waypoint. With usable localizer signal, shows TO.
21. RECIPROCAL COURSE INDEX - Indicates reciprocal of selected VOR or RNAV course.
22. NAV INDICATOR FLAG - When in view, red NAV position (Flag) indicates the selected VOR or localizer signal is unusable.
23. AUTOMATIC RADIAL CENTERING (ARC - PUSH-TO/PULL-FR) SELECTOR - In center detent, functions as conventional OBS. Pushed to inner (Momentary On) position, turns OBS course card (14) to center course deviation pointer (19) with a TO flag (20 or 24), then returns to conventional OBS selection. Pulled to outer detent, continuously drives OBS course card (14) to indicate bearing from VOR station, keeping course deviation pointer (19) centered, with a FROM flag (20 or 24). ARC function will not operate on localizer frequencies.

NOTE

Engaging either Automatic Radial Centering (ARC) functions will alter the airplane's course anytime the autopilot is engaged and coupled to any frequency other than a localizer frequency.

Figure 1. Cessna 400 Nav/Com Set, Operating Controls and Indicators  
(Sheet 3 of 4)

24. INDICATOR (TO/FR) - Operates only with a usable VOR or localizer signal. When white flag is in view, indicates whether selected course is TO or FROM station. With usable localizer signal, shows TO.
25. AUTOMATIC RADIAL CENTERING (ARC) LAMP - Amber light illuminates when Automatic Radial Centering is in use.

Figure 1. Cessna 400 Nav/Com Set, Operating Controls and Indicators  
(Sheet 4 of 4)

## SECTION 3

### EMERGENCY PROCEDURES

There is no change to the airplane emergency procedures when this avionic equipment is installed. However, if the frequency readouts fail, the frequency controls should not be moved due to the difficulty of obtaining a known frequency under this condition. The radio will remain operational on the last frequency selected, and the preset frequencies in MEMORY may be selected by pressing the appropriate MEMORY pushbutton.

## SECTION 4

### NORMAL PROCEDURES

#### PRESETTING NAV/COM FREQUENCIES IN MEMORY:

1. COM OFF/VOL CONTROL -- TURN ON; adjust to desired audio level.
2. MEMORY 1 Pushbutton -- PRESS desired NAV or COM pushbutton 1 momentarily to alert the memory bank of a forthcoming frequency to be stored.
3. FREQUENCY SELECTORS -- MANUALLY ROTATE corresponding NAV or COM frequency selectors (press C pushbutton as required to select the desired third fractional COM digit) until the desired frequency is shown in the operating frequency readout window. The frequency displayed will be automatically transferred into MEMORY 1.

#### NOTE

Do not press the C pushbutton more than about 2 seconds while selecting fractional frequencies or you will activate the MEMORY test function.

4. MEMORY 2 and 3 Pushbutton -- REPEAT STEPS 2 and 3 using next desired NAV or COM MEMORY to be stored. Up to 3 NAV and 3 COM frequencies may be stored for automatic recall frequency selection.

#### NOTE

The operating frequency set in the selected MEMORY position will automatically be changed in the memory bank anytime the operating frequency is manually changed.

**COMMUNICATION RECEIVER-TRANSMITTER OPERATION:**

1. COM OFF/VOL Control -- TURN ON.
2. XMTR SEL Switch -- SET to desired 400 Nav/Com (on audio control panel).
3. SPEAKER/PHONE (or AUTO) Switch -- SET to desired mode (on audio control panel).
4. COM Frequency Selection -- SELECT desired operating frequency by either pressing a COM MEMORY 1, 2 or 3 pushbutton to recall a preset frequency, or by manually selecting the desired operating frequency using the COM frequency selectors and C pushbutton.
5. VOL Control -- ADJUST to desired audio level.
6. SQ Control -- ROTATE counterclockwise to decrease background noise as required.
7. Mike Button:
  - a. To Transmit -- DEPRESS and SPEAK into microphone.

**NOTE**

Sidetone may be selected by placing the AUTO selector switch (on audio control panel) in either the SPEAKER or PHONE position. Adjustment of sidetone may be accomplished by adjusting the sidetone pot located inside the audio control panel.

- b. XMIT Annunciator Light -- CHECK ON (green light illuminated).
- c. To Receive -- RELEASE mike button.

**NAVIGATION OPERATION:**

1. COM OFF/VOL Control -- TURN ON; adjust to desired audio level.
2. SPEAKER/PHONE (or AUTO) Switch -- SET to desired mode (on audio control panel).
3. NAV Frequency Selection -- SELECT desired operating frequency by either pressing a NAV MEMORY 1, 2 or 3 pushbutton to recall a preset frequency, or by using NAV frequency selectors.
4. NAV VOL Control -- ADJUST to desired audio level.
5. ID-VOX-T Switch:
  - a. To Identify Station -- SET to ID to hear navigation station identifier signal.
  - b. To Filter Out Station Identifier Signal -- SET to VOX to include filter in audio circuit.
6. ARC PUSH-TO/PULL-FROM Knob (If Applicable):
  - a. To Use As Conventional OBS -- PLACE in center detent and select desired course.



- b. To Obtain Bearing TO VOR Station -- PUSH knob to inner (Momentary On) position.

NOTE

ARC lamp will illuminate amber while the course card is moving to center the course deviation pointer. After alignment has been achieved to reflect bearing TO VOR, automatic radial centering will automatically shut down, causing the ARC lamp to go out and the ARC knob to return to center detent position and function as a normal OBS.

- c. To obtain Continuous Bearing FROM VOR Station -- PULL (ARC/PULL-FR) knob to outer detent.

NOTE

ARC lamp will illuminate amber, OBS course card will turn to center the course deviation pointer with a FROM flag to indicate bearing from VOR station. This system will continually drive to present the VOR radial the aircraft is on until manually returned to the center detent by the pilot.

7. AP/CPLD Annunciator -- CHECK ON (if 400B or 400B IFCS autopilot is engaged), amber light illuminated.

NOTE

The AP/CPLD annunciator light is only operational with a 400B or 400B IFCS autopilot installation.

VOR SELF-TEST OPERATION:

1. COM OFF/VOL Control -- TURN ON.
2. NAV Frequency Selector Switches -- SELECT usable VOR station signal.
3. OBS Knob -- SET for 0° course at course index; course deviation pointer centers or deflects left or right, depending on bearing of signal; NAV/TO-FROM indicator shows TO or FROM.
4. ID/VOX/T Switch -- PRESS to T and HOLD at T; course deviation pointer centers, NAV/TO-FROM indicator shows FROM and AP/CPLD and XMIT annunciators light.
5. OBS Knob -- TURN to displace course approximately 10° to either side of 0° (while holding ID/VOX/T to T). Course deviation pointer deflects full scale in direction corresponding to course displacement. NAV/TO-FROM indicator shows FROM.

6. ID/VOX/T Switch -- RELEASE for normal operation.

**NOTE**

This test does not fulfill the requirements of FAR 91.25.

**MEMORY TEST OPERATION:**

1. C Pushbutton -- PUSH for about 2 seconds. Each COM and NAV MEMORY pushbutton (1, 2 & 3) will illuminate white, in turn, with the corresponding preset frequency displayed.

**NOTE**

If the "keep-alive" circuit has not been interrupted, the MEMORY test will always start with the last COM MEMORY selected and cycle through the remaining COM and NAV preset frequencies. The MEMORY test will always stop on the last selected COM and NAV preset frequencies.

## **SECTION 5**

### **PERFORMANCE**

There is no change to the airplane performance when this avionic equipment is installed. However, the installation of an externally mounted antenna or several related external antennas, will result in a minor reduction in cruise performance.

## SUPPLEMENT

# CESSNA 400 AREA NAVIGATION SYSTEM (Type RN-478A)

## SECTION 1 GENERAL

The Cessna 400 Area Navigation System (Type RN-478A) consists of an RN-478A Area NAV Computer (RNAV), a compatible VHF navigation receiver and course deviation indicator, and the Type R-476A distance measuring equipment (DME). The RNAV includes converter circuits which operate with the VHF navigation receiver and produce positional information for display by the course deviation indicator. It also includes computer circuits which combine the bearing information from the navigation set with the distance information from the R-476A DME to establish navigation data for selected waypoints. During RNAV operation, a course scalloping suppressor circuit suppresses the spurious navigation signal phases to provide stable waypoint information which enhances autopilot operation. The 400 RNAV is coupled to the number 2 Nav/Com and includes storage for 3 waypoints.

Ground speed/time-to-station information to the selected VOR (not the waypoint) is available on this system. This capability, along with the course scalloping suppression (radial straightening), may be used to an advantage while tracking inbound or outbound from the VOR station by programming a waypoint directly over the associated VOR (000.0°/000.0 nautical miles) and using RNAV for course smoothing while enroute.

### CAUTION

If RNAV set is removed from the airplane or becomes inoperative, the associated VHF navigation indicator will be inoperative.

All operating controls and displays which are part of the RN-478A are shown and described in Figure 1. Other controls required for operation of the Cessna 400 Area Navigation System are included on the VHF navigation receiver and on the R-476A DME control; these controls are shown and described in the respective supplements included for this equipment.

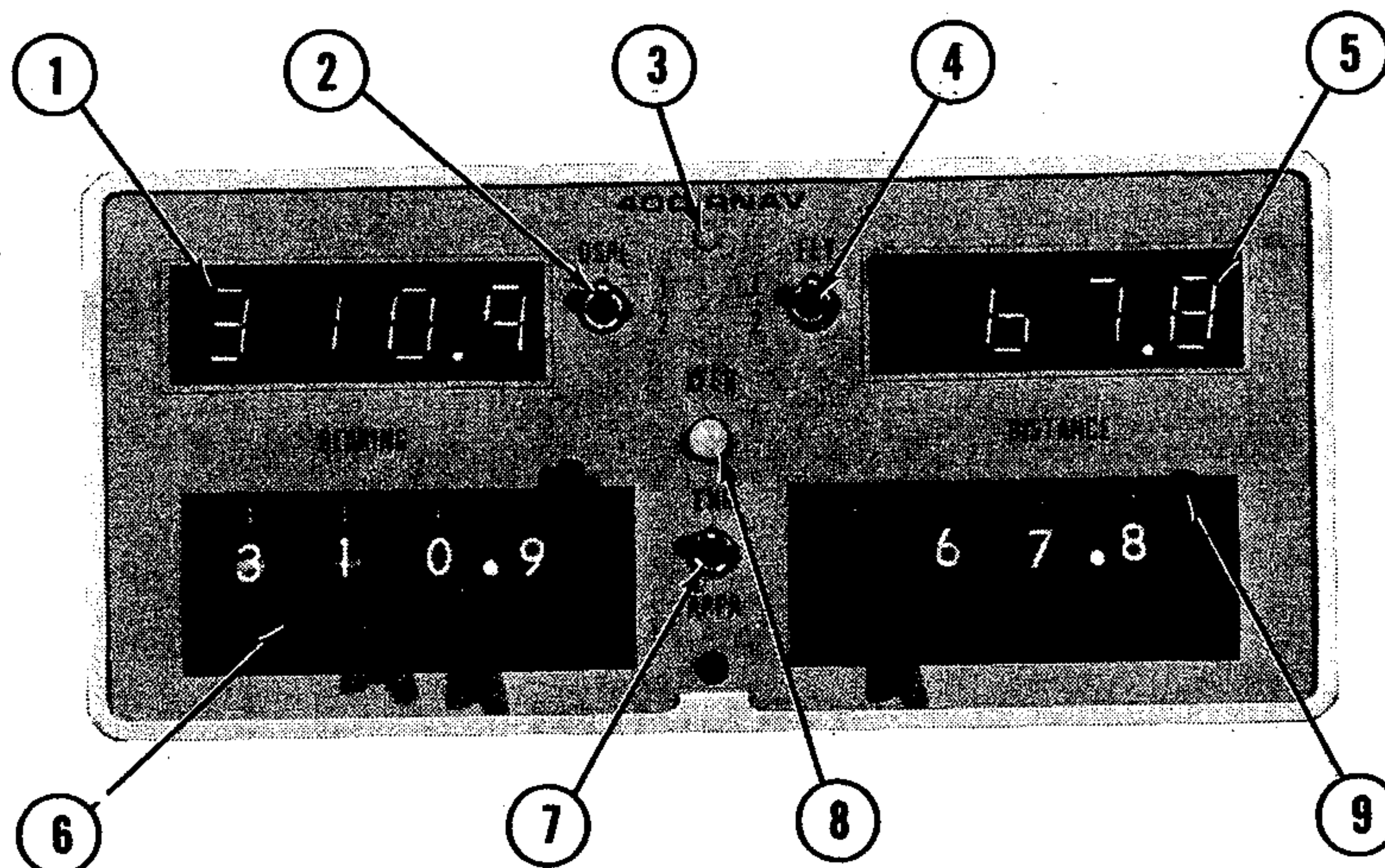

1. BEARING DISPLAY READOUT - Depending on position of DSPL Switch, displays bearing programmed for waypoint 1 or waypoint 2.
2. DISPLAY 1-2 SWITCH (DSPL) - Determines information shown on DISTANCE and BEARING displays: In position 1, distance and bearing programmed for waypoint 1 are displayed; in position 2, distance and bearing programmed for waypoint 2 are displayed.
3. FLY/DISPLAY LAMP - Flashes amber when FLY Switch and DSPL Switch are not set to same number; indicates that waypoint information being displayed is not waypoint information being flown.
4. FLY SWITCH - Determines waypoint being used for navigation. In position 1, waypoint 1 is in use; in position 2, waypoint 2 is in use.
5. DISTANCE DISPLAY READOUT - Depending on position of DSPL Switch, displays distance programmed for waypoint 1 or waypoint 2.
6. BEARING MINILEVER SWITCHES (4) - Select bearing of desired waypoint from VOR/DME station. May be used to store bearing of 3rd waypoint.
7. ENROUTE/APPROACH SWITCH (ENR/APPR) - Controls width of navigation corridor. ENR position provides standard ( $\pm 5$  NM) enroute sensitivity; APPR position provides standard ( $\pm 1-1/4$  NM) approach course sensitivity.

NOTE

Due to unreliable signals, do not operate in the APPR position when computed distance to waypoint exceeds 51 nautical miles.

8. TRANSFER PUSHBUTTON SWITCH (XFER) - Transfers waypoint distance and bearing from minilevers into either waypoint 1 or 2 as selected by DSPL switch position.
9. DISTANCE MINILEVER SWITCHES (4) - Select distance of desired waypoint from VOR/DME station. May be used to store distance of 3rd waypoint.

Figure 1. Cessna 400 Area Nav (Type RN-478A) Computer, Operating Controls and Indicators

## SECTION 2 LIMITATIONS

There is no change to the airplane limitations when this avionic equipment is installed. However, the following RNAV IFR approach limitation should be adhered to during airplane operation.

### OPERATING LIMITATION:

1. IFR Approaches -- Follow approved published RNAV instrument procedures.

## SECTION 3 EMERGENCY PROCEDURES

There is no change to the airplane emergency procedures when this avionic equipment is installed.

## SECTION 4 NORMAL PROCEDURES

### VOR/LOC OPERATION

#### VOR NAVIGATION CIRCUITS VERIFICATION TESTS:

1. See appropriate Nav/Com supplement.

#### VOR/LOC NAVIGATION:

As a convenience to the pilot, a separate supplement (Avionic Operation Guide) is supplied to explain the various procedures for using the VHF Navigation Set for VOR and localizer navigation. Refer to the Avionic Operations Guide for flight procedures.

### AREA NAVIGATION OPERATION

#### NOTE

Proper RNAV operation requires valid VOR and DME inputs to the RNAV system. In certain areas, the ground station antenna patterns and transmitter power may be inadequate to provide valid signals to the RNAV. For this

reason, intermittent RNAV signal loss may be experienced enroute. Prolonged loss of RNAV signal shall require the pilot to revert to other navigational procedures.

**WAYPOINT PROGRAMMING:**

1. Using a VFR sectional, enroute instrument chart, instrument approach plate, or enroute RNAV chart -- DETERMINE distance and bearing for desired waypoint(s) from appropriate VOR/DME stations.
2. VHF Navigation Receiver -- ON.
3. DME TEST/ON-OFF Switch -- ON.
4. DME Mode Selector Switch -- RNAV.
5. RNAV DSPL Switch -- 1.

**NOTE**

When DSPL and FLY switches are not set to the same waypoint number, the display/fly light slowly blinks on and off as a reminder to the pilot that values displayed are not those being used for navigation. This does not affect operation of the unit.

6. BEARING Minilever Switches -- SET to first waypoint bearing.
7. DISTANCE Minilever Switches -- SET to first waypoint distance.
8. XFER Pushbutton Switch -- PUSH in.
  - a. First waypoint bearing and distance are placed in memory as waypoint 1.
  - b. BEARING Display Readout -- DISPLAYS readout of first waypoint bearing.
  - c. DISTANCE Display Readout -- DISPLAYS readout of first waypoint distance.
9. RNAV DSPL Switch -- SET to 2.
10. BEARING Minilever Switches -- SET to second waypoint bearing.
11. DISTANCE Minilever Switches -- SET to second waypoint distance.
12. XFER Pushbutton Switch -- PUSH in.
  - a. Second Waypoint Readout -- BEARING and DISTANCE are placed in memory as waypoint 2.
  - b. BEARING Display Readout -- DISPLAYS readout of second waypoint bearing.
  - c. DISTANCE Display Readout -- DISPLAYS readout of second waypoint distance.
13. BEARING Minilever Switches -- SET to standby waypoint bearing.

14. DISTANCE Minilever Switches -- SET to standby waypoint distance.

NOTE

As first waypoint is reached, it can be replaced with the third "standby" waypoint (already set) before placing the RNAV "DSPL" switch to 2. Then a fourth waypoint, if necessary, can be set with the minilever selectors.

DISPLAY RELIABILITY TESTS:

NOTE

This test must be conducted following the "Waypoint Programming" procedures with the VHF Navigation Receiver and DME TEST/ON-OFF switches still in the ON position.

1. VHF Navigation Receiver Frequency Selector Switches -- SET to VOR frequency.
2. RNAV DSPL and FLY Switches -- DSPL set to 1, FLY set to 2.
  - a. Readout -- DISPLAYS first waypoint bearing and distance that was selected in Waypoint Programming.
  - b. Fly/Display Lamp (On RNAV Control Head) -- FLASHES.
3. RNAV DSPL and FLY Switches -- DSPL set to 2, FLY set to 1.
  - a. Readout -- DISPLAYS second waypoint bearing and distance.
  - b. Fly/Display Lamp (On RNAV Control Head) -- FLASHES.
4. RNAV DSPL and FLY Switches -- BOTH SET to same number.
  - a. Readout -- DISPLAYS waypoint bearing and distance as selected by DSPL switch.
  - b. Fly/Display Lamp (On RNAV Control Head) -- NOT LIGHTED.
5. DME Mode Selector Switch -- SET to RNAV.
  - a. Both RN and NM Annunciators on DME -- LIGHTED.
  - b. RN Lamp on Course Deviation Indicator -- LIGHTS.
6. VHF Navigation Receiver Frequency Selector Switches -- SET to LOC frequency.
  - a. Both RN and NM Annunciators -- LIGHTED.
  - b. RN Lamp on Course Deviation Indicator -- LIGHTED.
  - c. Course Deviation Indicator OFF(or NAV)/TO-FROM Indicator -- OFF (or NAV) flag in view.
7. DME Mode Selector Switch -- SET to NAV 1, NAV 2, or HOLD.
  - a. NM Annunciator on DME -- LIGHTED.
  - b. RN Annunciator on DME -- NOT LIGHTED.
  - c. RN Lamp on Course Deviation Indicator -- NOT LIGHTED.
  - d. Course Indicator OFF(or NAV)/TO-FROM Indicator -- Shows TO if a usable signal is received.

8. DME Mode Selector Switch -- RNAV.
9. DME TEST/ON-OFF Switch -- HOLD to TEST.
  - a. DME RN/NM Distance Display -- READOUT is 888.8.
  - b. DME KTS/MIN Ground Speed/Time-to-Station Display -- READOUT is 888.
  - c. RNAV BEARING Display -- READOUT is 888.8.
  - d. RNAV DISTANCE Display -- READOUT is 188.8.

**AREA NAVIGATION CIRCUITS SELF-TEST:**

1. VHF Navigation Receiver -- ON.
2. VHF Navigation Receiver Frequency Selector Switches -- SET to a usable VOR/DME frequency.
3. DME TEST/ON-OFF Switch -- ON.
4. DME Mode Selector Switch -- RNAV.
  - a. RN Lamp on Course Deviation Indicator -- LIGHTED.
5. RNAV Computer -- PROGRAMMED to waypoint.
6. DSPL and FLY Switches -- SET both to waypoint to be tested.
  - a. BEARING Display -- READOUT is waypoint bearing.
  - b. DISTANCE Display -- READOUT is waypoint distance.
  - c. Course Indicator -- RN LAMP lights.
7. Course Indicator OBS (or ARC) -- SET to waypoint bearing.
8. VHF Navigation Receiver ID/VOX/T Switch -- HOLD in T position.
  - a. Course Deviation Pointer -- CENTERS.
  - b. Course Deviation Indicator OFF(or NAV)/TO-FROM Flag -- Shows TO.
  - c. DME Distance Display -- READOUT is the same as the RNAV DISTANCE readout.

**NOTE**

After releasing the navigation receiver test (T) switch, the return to accurate computed bearing and distance data can take up to 60 seconds depending upon airplane position and waypoint.

## **SECTION 5 PERFORMANCE**

There is no change to the airplane performance when this avionic equipment is installed. However, the installation of an externally mounted antenna or several related external antennas, will result in a minor reduction in cruise performance.



## SUPPLEMENT

# CESSNA 400 ADF (Type R-446A)

## SECTION 1 GENERAL

The Cessna 400 ADF is an automatic direction finder set which provides continuous, visual bearing indications of the direction from which an RF signal is being received. It can be used for plotting position, for homing, and for aural reception of AM signals between 200 kHz and 1699 kHz. In addition, a crystal-controlled, beat frequency oscillator (BFO) permits coded identifier of stations transmitting keyed CW signals (Morse Code) to be heard.

The basic units of the Cessna 400 ADF are an R-446A Receiver with dual frequency selectors, a goniometer-indicator (IN-346A), and sense and loop antennas. The receiver and goniometer-indicator are panel-mounted units. The sense and loop antennas are mounted on the external airplane surfaces. Operating controls for the Cessna 400 ADF are mounted on the receiver front panel. The goniometer-indicator presents station bearing in degrees of azimuth. An automatic pointer-stow feature alerts the operator to non-ADF operation by slewing the pointer to the 3:00 o'clock position when the REC mode is selected.

The frequency range of the Cessna 400 ADF is electronically divided into three bands: 200-399 kHz, 400-799 kHz, and 800-1699 kHz. Frequency spacing within each band is in 1-kHz increments. The operating frequency and band are selected by a four-section Minilever switch which displays a digital readout of the frequency selected and supplies a binary code to control the logic circuits within the set. A secondary (standby) operating frequency is selected by another four-section Minilever switch. Frequency control of the ADF is switched to the primary or the secondary operating frequency by a toggle switch. The operating modes (ADF and REC) are selected by individual pushbutton switches. Additional pushbutton switches are used to select the BFO and to test signal reliability during ADF operation. Operating controls for the Cessna 400 ADF are shown and described in Figure 1.

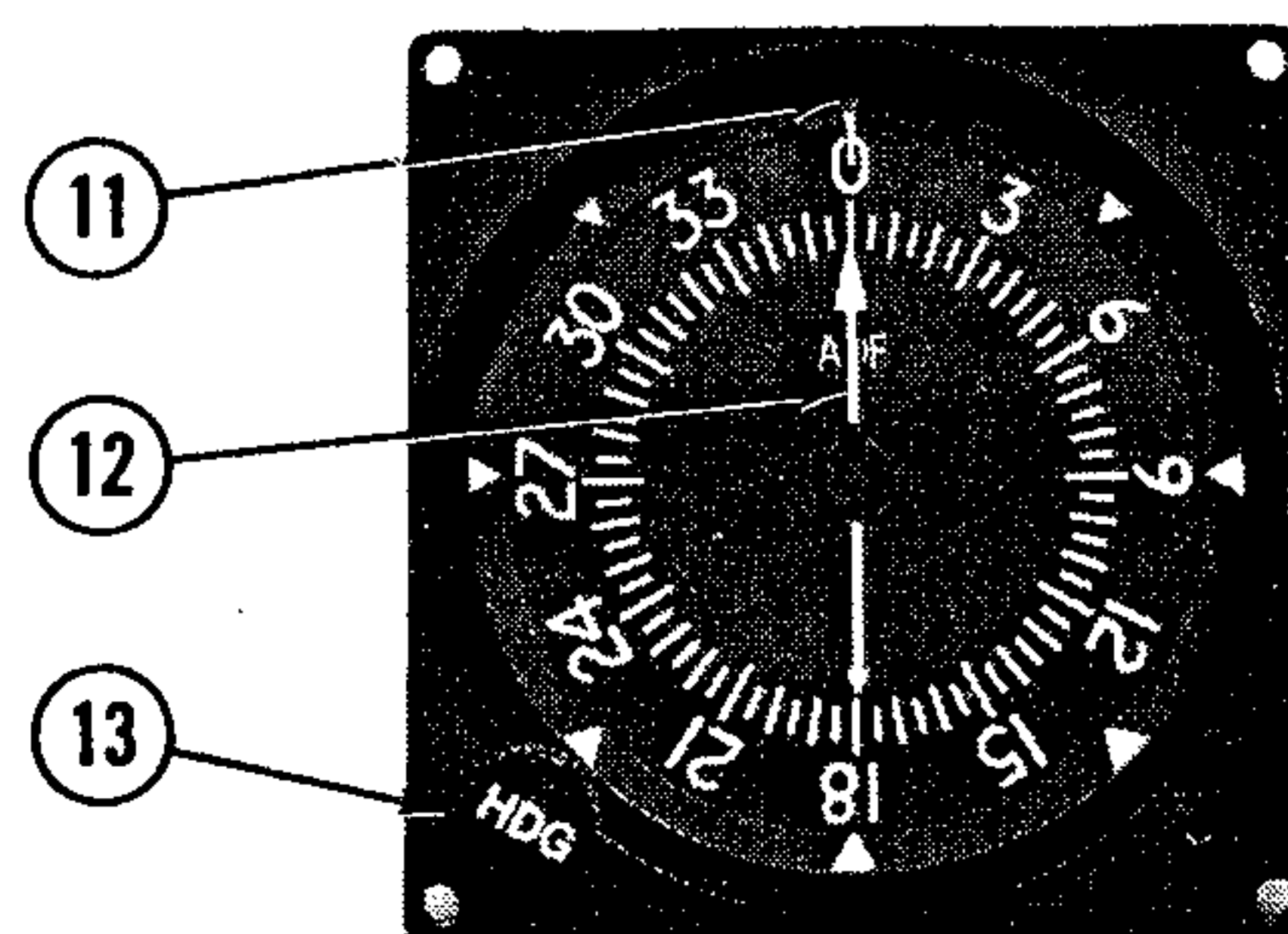
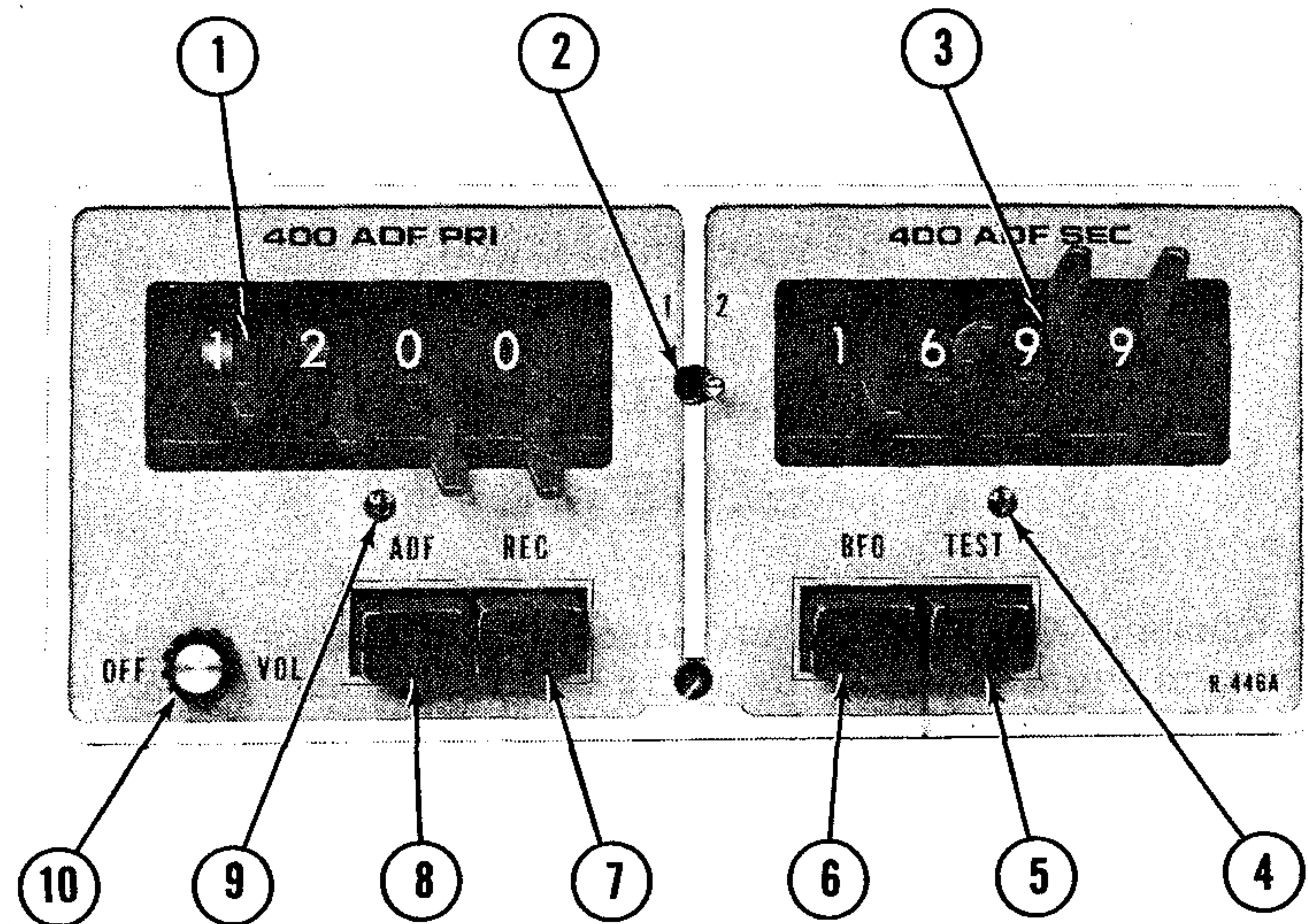

Figure 1. Cessna 400 ADF Operating Controls and Indicator  
(Sheet 1 of 2)

1. PRI (PRIMARY FREQUENCY SELECTOR) - Selects and displays "primary" frequency.
2. 1-2 - The "1" position activates "primary" (PRI) frequency. The "2" position activates "secondary" (SEC) frequency.
3. SEC (SECONDARY FREQUENCY SELECTOR) - Selects and displays "secondary" frequency.
4. SECONDARY RESELECT LAMP - Lamp will flash only when "secondary" (SEC) frequency selection is outside of operating range of the receiver and 1-2 switch is in the "2" position.
5. TEST - Momentary-on switch used only with ADF function to test bearing reliability. When held depressed, slews indicator pointer; when released, if bearing is reliable, pointer returns to original position.
6. BFO - Pushed in: Activates beat frequency oscillator tone to permit coded identifier of stations transmitting keyed CW signals (Morse Code) to be heard.
7. REC - Pushed in: Selects receive mode (set operates as a standard communications receiver using sense antenna only).

NOTE

In this position an automatic pointer stow feature will alert the pilot to non-ADF operation by positioning and retaining the pointer at the 3:00 o'clock position when the 400 ADF is in the REC function.

8. ADF - Pushed in: Selects ADF mode (set operates as automatic direction finder using loop and sense antennas).
9. PRIMARY RESELECT LAMP - Lamp will flash only when "primary" (PRI) frequency selection is outside of operating range of the receiver and 1-2 switch is in the "1" position.
10. OFF-VOL - Turns set on or off and adjusts receiver volume.
11. INDEX - Fixed reference line for dial rotation adjustment.
12. POINTER - When HDG control is adjusted, indicates either relative, magnetic, or true bearings of a radio station.
13. HDG - Rotates dial to facilitate relative, magnetic, or true bearing information.

Figure 1. Cessna 400 ADF Operating Controls and Indicator  
(Sheet 2 of 2)

## SECTION 2 LIMITATIONS

There is no change to the airplane limitations when this avionic equipment is installed.

## SECTION 3 EMERGENCY PROCEDURES

There is no change to the airplane emergency procedures when this avionic equipment is installed.

## SECTION 4 NORMAL PROCEDURES

TO OPERATE AS A COMMUNICATIONS RECEIVER ONLY:

1. OFF/VOL Control -- ON.
2. REC Pushbutton -- PUSH in.

### NOTE

ADF indicator pointer will stow at a 90-degree position to alert the pilot to non-ADF operation.

3. PRI Frequency Selectors -- SELECT desired operating frequency.
4. SEC Frequency Selectors -- SELECT desired operating frequency.
5. 1-2 Selector Switch -- 1 position.

### NOTE

1-2 selector switch can be placed in the 2 position for operation on secondary frequency. The re-select lamp will flash only when frequency selection is outside of operating range of the receiver.

6. ADF SPEAKER/PHONE Switch -- SELECT speaker or phone position.
7. VOL Control -- ADJUST to desired listening level.

TO OPERATE AS AN AUTOMATIC DIRECTION FINDER:

1. OFF/VOL Control -- ON.
2. PRI Frequency Selectors -- SELECT desired operating frequency.
3. SEC Frequency Selectors -- SELECT desired operating frequency.
4. 1-2 Selector Switch -- 1 position.

NOTE

1-2 selector switch can be placed in the 2 position for operation on secondary frequency. The re-select lamp will flash only when frequency selection is outside of operating range of the receiver.

5. ADF SPEAKER/PHONE Switch -- SELECT speaker or phone position as desired.
6. ADF Pushbutton -- PUSH in and note relative bearing on ADF indicator.
7. HDG Control -- SET goniometer-indicator dial so that index indicates 0°, magnetic, or true heading of airplane. Pointer then indicates relative, magnetic, or true bearing to station.
8. VOL Control -- ADJUST to desired listening level.

NOTE

When switching stations, place function pushbutton in the REC position. Then, after station has been selected, place function pushbutton in the ADF position to resume automatic direction finder operation. (This practice prevents the bearing indicator from swinging back and forth as frequency dial is rotated.)

TO TEST RELIABILITY OF AUTOMATIC DIRECTION FINDER:

1. ADF Pushbutton -- PUSH in and note relative bearing on indicator.
2. TEST Pushbutton -- PUSH in and hold TEST button unit indicator pointer slews off indicated bearing at least 10 to 20 degrees.
3. TEST Pushbutton -- RELEASE and OBSERVE that indicator pointer returns to the same relative bearing as in step (1).

TO OPERATE BFO:

1. OFF/VOL Control -- ON.
2. ADF SPEAKER/PHONE Switch -- SELECT speaker or phone position.
3. BFO Pushbutton -- PUSH in.
4. 1-2 Selector Switch -- SELECT 1 position to activate PRI frequency

or 2 to activate SEC frequency that is transmitting keyed CW signals (Morse Code).

5. VOL Control -- ADJUST to desired listening level.

**NOTE**

A 1000-Hz tone is heard in the audio output when CW signal (Morse Code) is tuned in properly.

## **SECTION 5 PERFORMANCE**

There is no change to the airplane performance when this avionic equipment is installed. However, the installation of an externally mounted antenna or several related external antennas, will result in a minor reduction in cruise performance.

# **SUPPLEMENT**

## **CESSNA 400 DME**

### **(TYPE R-476A)**

#### **SECTION 1**

#### **GENERAL**

The Cessna 400 DME (Type R-476A) is the airborne "interrogator" portion of a navigation system which supplies continuous, accurate, slant range distance information from a fixed ground station to an aircraft in flight.

Except for selection of the operating channel, which is selected by the VHF navigation receiver frequency selector switches, the Cessna 400 DME is capable of independent operation. The equipment consists of a panel-mounted C-476A Control Unit which contains all of the operating controls and displays, and a remotely mounted RTA-476A Receiver-Transmitter. The RTA-476A transmits interrogating pulse pairs on 200 channels between 1041 MHz and 1150 MHz; it receives associated ground-to-air replies between 978 MHz and 1213 MHz. The C-476A Control Unit digitally displays distances up to 200 nautical miles and either ground speed or time-to-station information, as selected. All operating controls and displays for the DME are shown in Figure 1, and the functions of each are described.

#### **SECTION 2**

#### **LIMITATIONS**

There is no change to the airplane emergency procedures when this avionic equipment is installed.

#### **SECTION 3**

#### **EMERGENCY PROCEDURES**

There is no change to the airplane emergency procedures when this avionic equipment is installed.

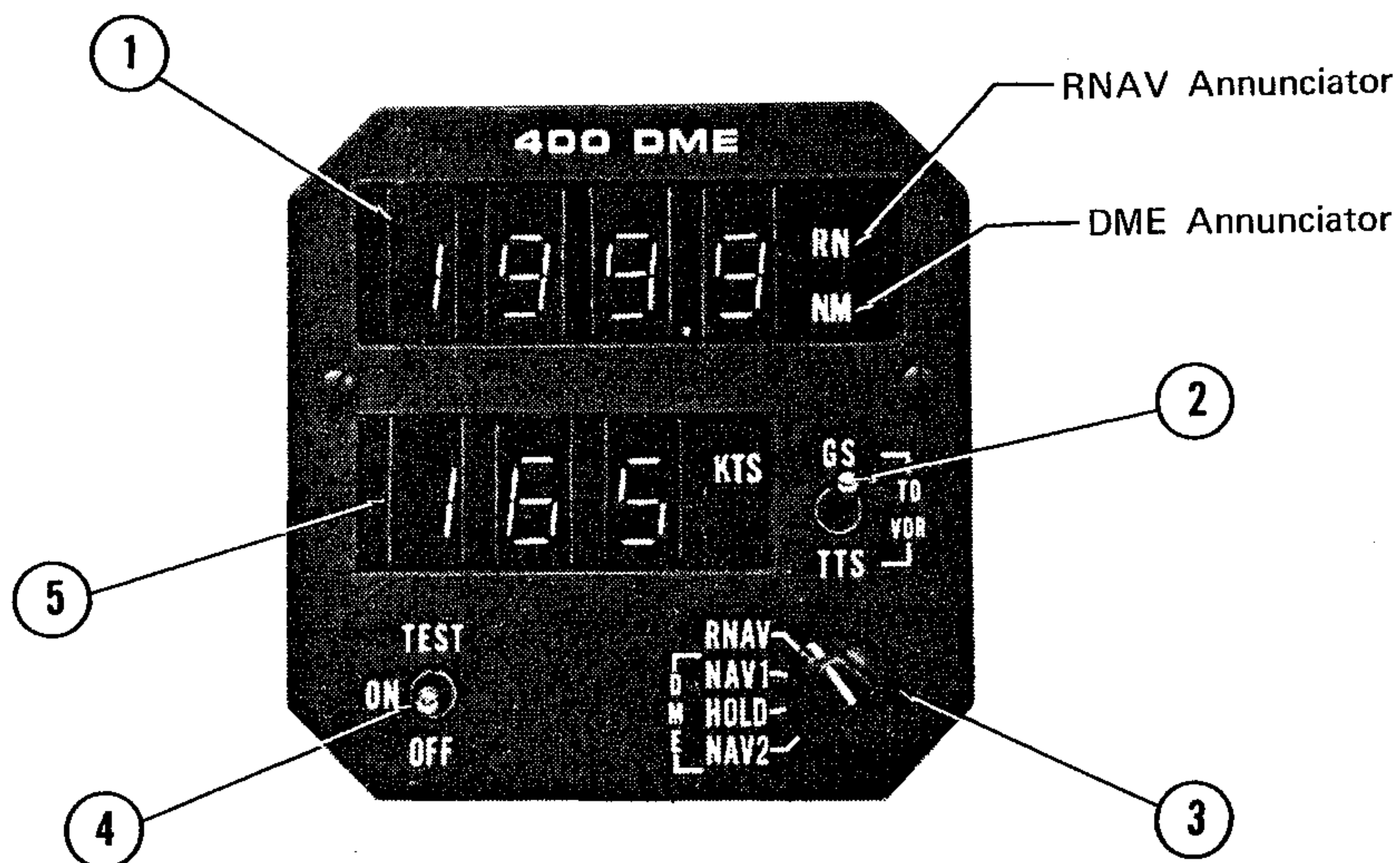

1. **DISTANCE DISPLAY** - In NAV 1, NAV 2, or HOLD mode, displays distance to selected VOR/DME station in nautical miles; only NM (Nautical Miles) annunciator lights. In RNAV mode, displays distance to selected waypoint in nautical miles; both RN (RNAV) and NM annunciators light.
2. **GS/TTS SELECTOR SWITCH** - In NAV 1, NAV 2, or HOLD mode, selects display of ground speed (GS) or time-to-station (TTS). In RNAV mode, display shows ground speed component to or from the VOR (not to waypoint) or the time to the VOR station at that indicated ground speed.
3. **DME MODE SELECTOR SWITCH** - Selects DME operating mode as follows:
  - RNAV: Selects area navigation operation; selects display of nautical miles (distance) to selected RNAV waypoint.
  - NAV 1: Selects DME operation with No. 1 VHF navigation set; enables channel selection by NAV 1 frequency selector switches.
  - HOLD: Selects DME memory circuit; DME remains channeled to station to which it was channeled when HOLD was selected; display of distance continues to be nautical miles to that station. Both the NAV 1 and the NAV 2 sets may be set to new operation frequencies.

**CAUTION**

In the HOLD mode, there is no annunciation of the VOR/DME station frequency.

NAV 2: Selects DME operation with No. 2 VHF navigation set; enables channel selection by NAV 2 frequency selector switches.

Figure 1. Cessna 400 DME (Type R-476A) (Sheet 1 of 2)



4. TEST/ON-OFF SWITCH - Controls application of power to DME circuits (turns equipment on or off); selects display lamp test for DME and RNAV displays.
5. GROUND SPEED/TIME DISPLAY - Displays ground speed in knots or time-to-station in minutes, as follows:
  - a. With GS/TTS Switch set to GS, displays ground speed component to or from station in knots (aircraft must be flying directly to or from the VOR/DME station for true ground speed indication).
  - b. With GS/TTS Switch set to TTS, displays time to VOR/DME station in minutes at the ground speed component indicated.
  - c. With GS/TTS in RNAV mode will display ground speed component or time-to-station at that speed to the selected VOR (not the waypoint).

## SECTION 4 NORMAL PROCEDURES

### DME OPERATION:

1. TEST/ON-OFF Switch -- SET to ON.
2. DME Mode Selector Switch -- SET to NAV 1 or NAV 2.
3. NAV 1 and NAV 2 VHF Navigation Receivers -- ON; SET FREQUENCY selector switches to VOR/DME station frequencies, as required.

### NOTE

When the VOR frequency is selected, the appropriate DME frequency is automatically channeled. Therefore, the system does not provide independent operation of the DME for reception of the DME Morse Code identifier.

4. GS/TTS Switch -- SET as desired.
5. TEST/ON-OFF Switch -- HOLD to TEST:
  - a. Distance-to-Station Display readout is 188.8.
  - b. Knots/Minutes Display readout is 888.
6. TEST/ON-OFF Switch -- RELEASE to ON; display readouts return to normal.

## SECTION 5 PERFORMANCE

There is no change to the airplane performance when this avionic equipment is installed. However the installation of an externally mounted antenna or several related external antennas, will result in a minor reduction in cruise performance.

## SUPPLEMENT

# CESSNA 400 MARKER BEACON (Type R-402A)

## SECTION 1 GENERAL

The system consists of a 75 MHz marker beacon receiver, three indicator lights, a speaker/phone selector switch, a light dimming control, an ON/OFF/VOLUME control, and a 75 MHz marker beacon antenna. In addition, a HI-LO-TEST switch is provided on all airplanes except the 152 series airplanes for sensitivity selection and test selection. On 152 series airplanes, a HI-LO sensitivity selector switch is provided with a separate press-to-test button.

This system provides visual and aural indications of 75 MHz ILS marker beacon signals as the marker is passed. The following table lists the three most currently used marker facilities and their characteristics.

### MARKER FACILITIES

---

MARKER	IDENTIFYING TONE	LIGHT*
Inner	Continuous 6 dots/sec (300 Hz)	White
Middle	Alternate dots and dashes (1300 Hz)	Amber
Outer	2 dashes/sec (400 Hz)	Blue

---

\* When the identifying tone is keyed, the respective indicating light will blink accordingly.

---

Operating controls and indicator lights are shown and described in Figure 1.

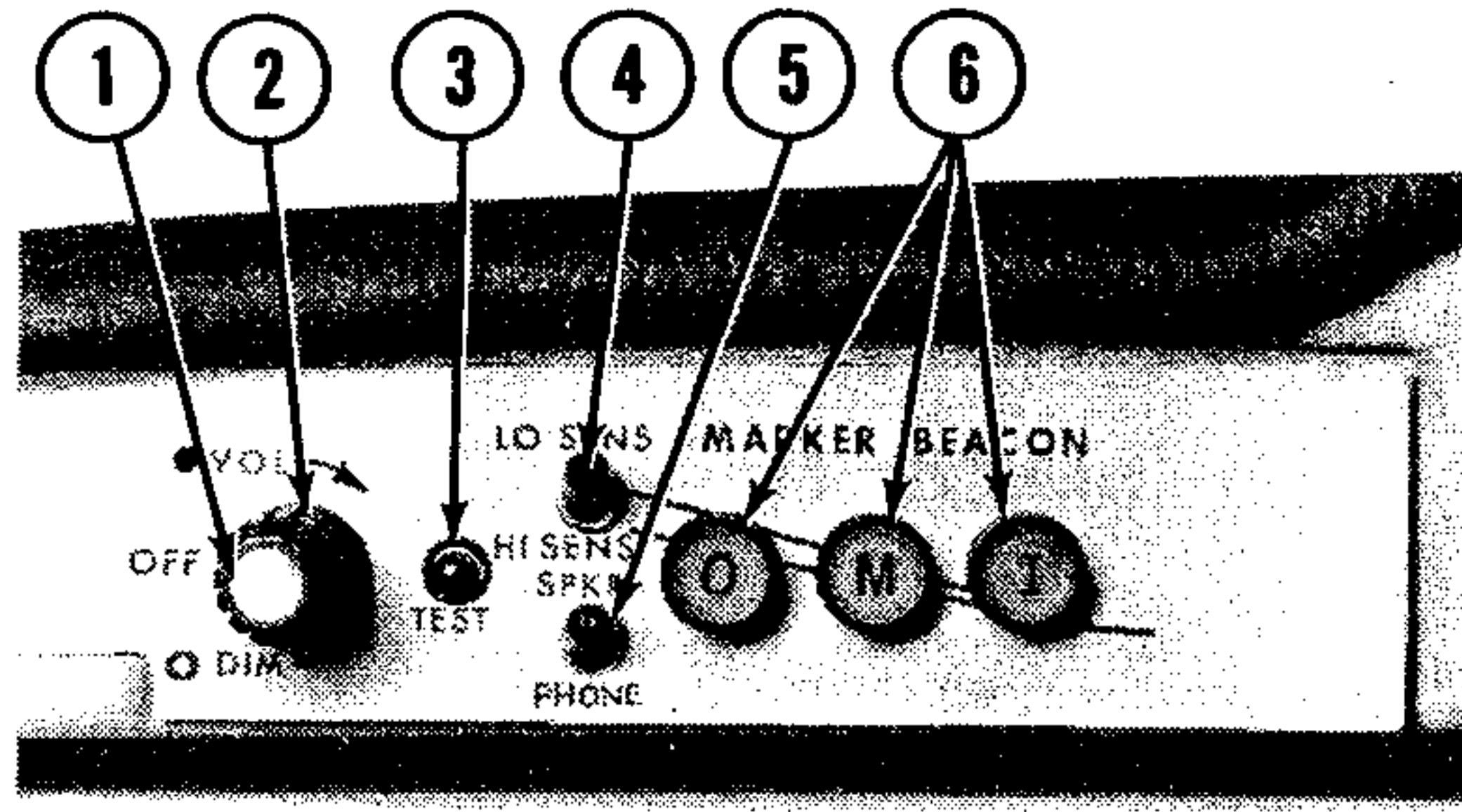

TYPICAL INSTALLATION  
ON ALL 152 MODEL SERIES

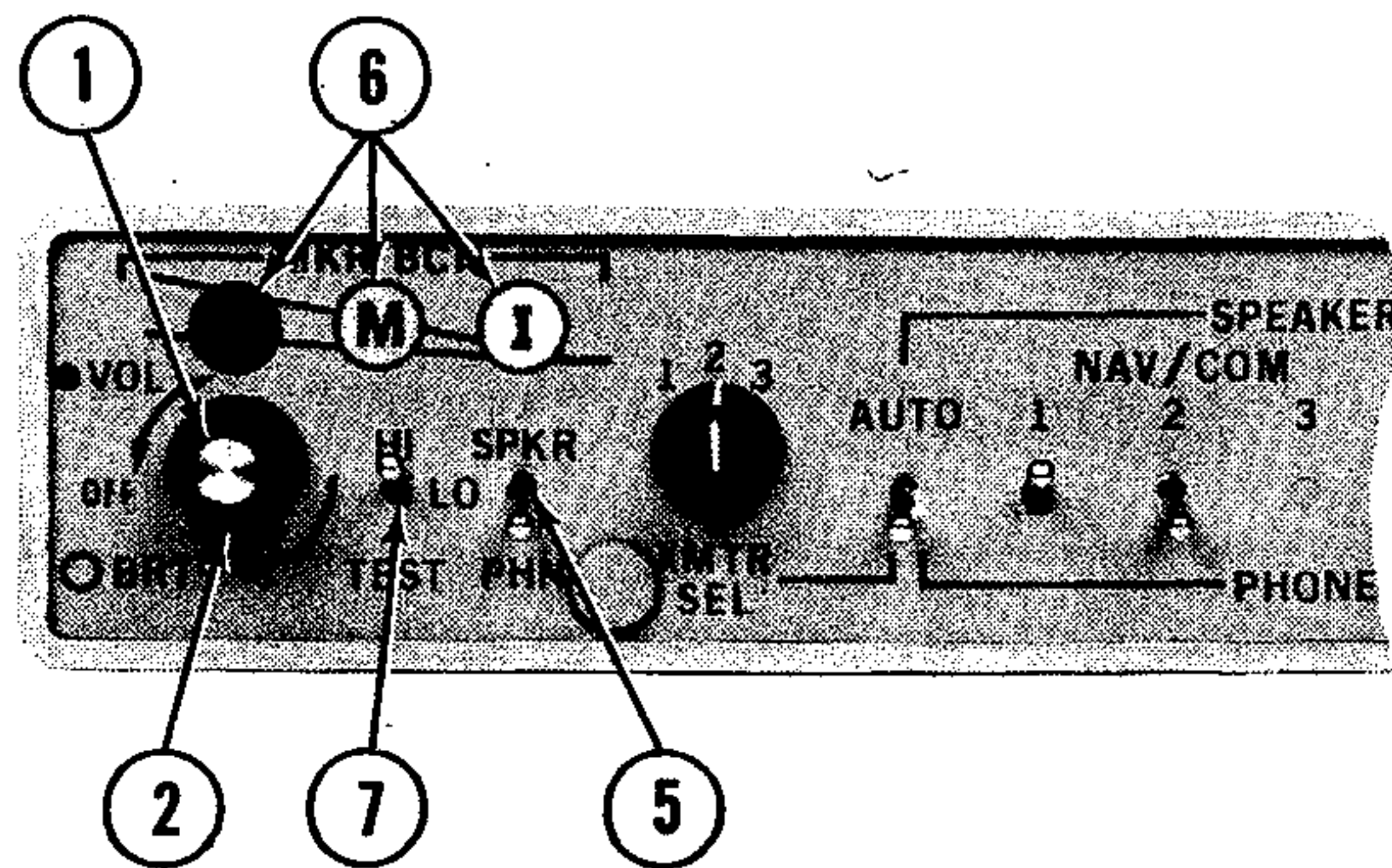

TYPICAL INSTALLATION  
ON ALL MODELS EXCEPT  
152 MODEL SERIES

Figure 1. Cessna 400 Marker Beacon Operating Controls and Indicator  
Lights (Sheet 1 of 2)

PILOT'S OPERATING HANDBOOK CESSNA 400 MARKER BEACON  
SUPPLEMENT (TYPE R-402A)

1. OFF/VOLUME CONTROL - The small, inner control turns the set on or off and adjusts the audio listening level. Clockwise rotation turns the set on and increases the audio level.
2. DIM/BRT CONTROL - The large, outer control provides light dimming for the marker lights. Clockwise rotation increases light intensity.
3. TEST SWITCH - (152 Model Series Only) When the press-to-test switch button is depressed, the marker beacon lights will illuminate, indicating the lights are operational (the test position is a lamp test function only).
4. LO/HI SENS SWITCH - (152 Model Series Only) In the LO position (Up), receiver sensitivity is positioned for ILS approaches. In the HI position (Down), receiver sensitivity is positioned for airway flying.
5. SPEAKER/PHONE SWITCH - Selects speaker or phone for aural reception.
6. MARKER BEACON INDICATOR LIGHTS - Indicates passage of outer, middle and inner marker beacons. The OUTER light is blue, the MIDDLE light is amber and the INNER light is white.
7. HI/LO/TEST SWITCH - (All Models Except 152 Model Series) In the HI position (Up), receiver sensitivity is positioned for airway flying. In the LO position (Center), receiver sensitivity is positioned for ILS approaches. In the TEST position (Down), the marker lights will illuminate, indicating the lights are operational (the test position is a lamp test function only).

Figure 1. Cessna 400 Marker Beacon Operating Controls and Indicator  
Lights (Sheet 2 of 2)

## **SECTION 2 LIMITATIONS**

There is no change to the airplane limitations when this avionic equipment is installed.

## **SECTION 3 EMERGENCY PROCEDURES**

There is no change to the airplane emergency procedures when this avionic equipment is installed.

## **SECTION 4 NORMAL PROCEDURES**

TO OPERATE:

1. OFF/VOL Control -- VOL position and adjust to desired listening level.
2. LO/HI SENS Switch -- SELECT HI position for airway flying or LO position for ILS approaches.
3. SPKR/PHONE Switch -- SELECT speaker or phone audio.
4. TEST Switch -- PRESS and ensure that marker beacon indicator lights are operative.
5. BRT Control -- SELECT BRT (full clockwise). ADJUST as desired when illuminated over marker beacon.

## **SECTION 5 PERFORMANCE**

There is no change to the airplane performance when this avionic equipment is installed. However, the installation of an externally mounted antenna or several related external antennas, will result in a minor reduction in cruise performance.

**SUPPLEMENT**

**CESSNA 400 TRANSPONDER**  
**(Type RT-459A)**

**AND**

**OPTIONAL ENCODING ALTIMETER**  
**(Type EA-401A)**

**SECTION 1**

**GENERAL**

The Cessna 400 Transponder (Type 459A), shown in Figure 1, is the airborne component of an Air Traffic Control Radar Beacon System (ATCRBS). The transponder enables the ATC ground controller to "see" and identify the aircraft, while in flight, on the control center's radar scope more readily.

The 400 Transponder consists of a panel-mounted unit and an externally-mounted antenna. The transponder receives interrogating pulse signals on 1030 MHz and transmits coded pulse-train reply signals on 1090 MHz. It is capable of replying to Mode A (aircraft identification) and Mode C (altitude reporting) interrogations on a selective reply basis on any of 4,096 information code selections. When an optional panel mounted EA-401A Encoding Altimeter (not part of 400 Transponder System) is included in the avionic configuration, the transponder can provide altitude reporting in 100-foot increments between -1000 and +35,000 feet.

All Cessna 400 Transponder operating controls, with the exception of the optional altitude encoder's altimeter setting knob, are located on the front panel of the unit. The altimeter setting knob is located on the encoding altimeter. Functions of the operating controls are described in Figure 1.

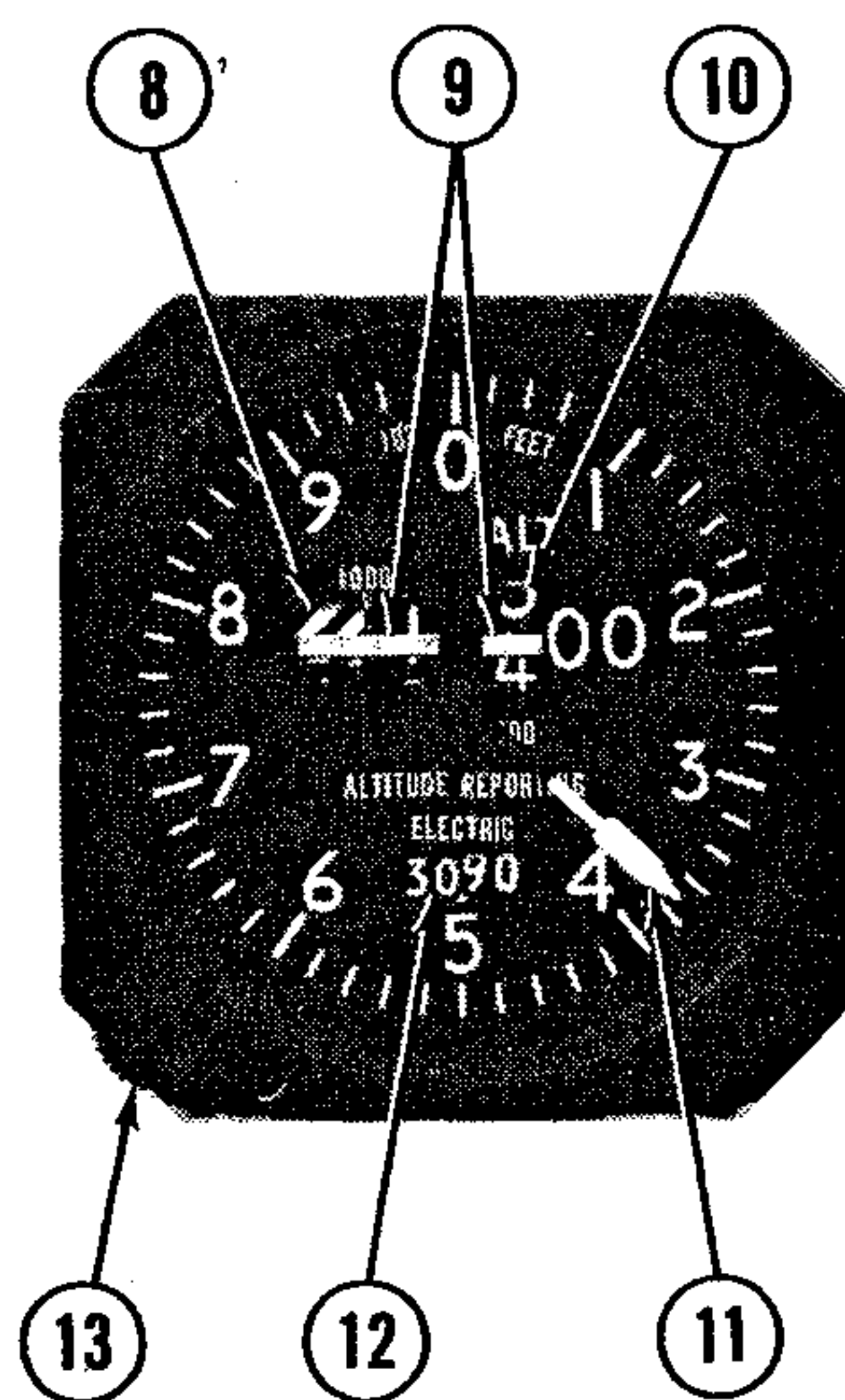
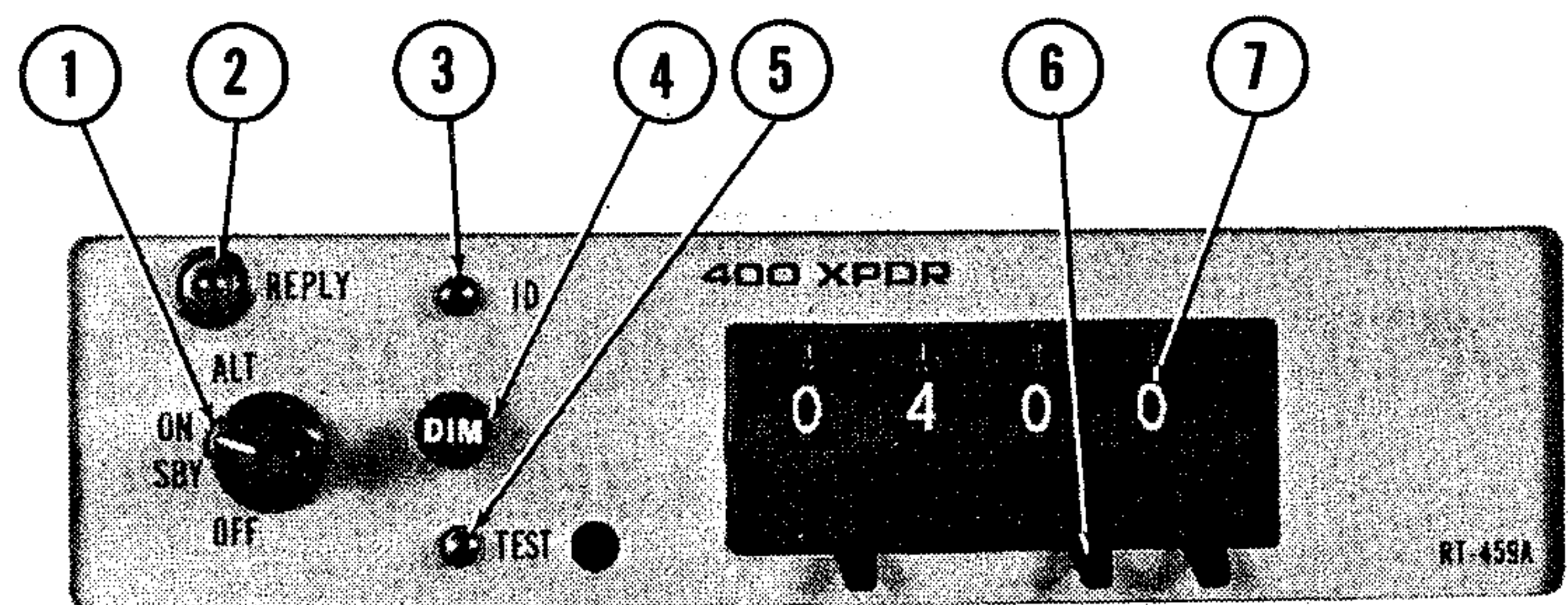

Figure 1. Cessna 400 Transponder and Encoding Altimeter  
Operating Controls (Sheet 1 of 2)



1. **FUNCTION SWITCH** - Controls application of power and selects transponder operating mode as follows:
  - OFF - Turns set off.
  - SBY - Turns set on for equipment warm-up or standby power.
  - ON - Turns set on and enables transponder to transmit Mode A (aircraft identification) reply pulses.
  - ALT - Turns set on and enables transponder to transmit either Mode A (aircraft identification) reply pulses or Mode C (altitude reporting) pulses selected automatically by the interrogating signal.
2. **REPLY LAMP** - Lamp flashes to indicate transmission of reply pulses; glows steadily to indicate transmission of IDENT pulse or satisfactory self-test operation. (Reply Lamp will also glow steadily during initial warm-up period.)
3. **IDENT (ID) SWITCH** - When depressed, selects special pulse identifier to be transmitted with transponder reply to effect immediate identification of aircraft on ground controller's display. (Reply Lamp will glow steadily during duration of IDENT pulse transmission.)
4. **DIMMER (DIM) CONTROL** - Allows pilot to control brilliance of Reply Lamp.
5. **SELF-TEST (TEST) SWITCH** - When depressed, causes transponder to generate a self-interrogating signal to provide a check of transponder operation. (Reply Lamp will glow steadily to verify self test operation.)
6. **REPLY-CODE SELECTOR SWITCHES (4)** - Select assigned Mode A Reply Code.
7. **REPLY-CODE INDICATORS (4)** - Display selected Mode A Reply Code.
8. **1000-FOOT DRUM TYPE INDICATOR** - Provides digital altitude readout in 1000-foot increments between -1000 feet and +35,000 feet. When altitude is below 10,000 feet, a diagonally striped flag appears in the 10,000-foot window.
9. **OFF INDICATOR WARNING FLAG** - Flag appears across altitude readout when power is removed from altimeter to indicate that readout is not reliable.
10. **100-FOOT DRUM TYPE INDICATOR** - Provides digital altitude readout in 100-foot increments between 0 feet and 1000 feet.
11. **20-FOOT INDICATOR NEEDLE** - Indicates altitude in 20-foot increments between 0 feet and 1000 feet.
12. **ALTIMETER SETTING SCALE - DRUM TYPE** - Indicates selected altimeter setting in the range of 28.1 to 30.99 inches of mercury on the standard altimeter or 946 to 1049 millibars on the optional altimeter.
13. **ALTIMETER SETTING KNOB** - Dials in desired altimeter setting in the range of 27.9 to 31.0 inches of mercury on standard altimeter or 950 to 1050 millibars on the optional altimeter.

Figure 1. Cessna 400 Transponder and Encoding Altimeter  
Operating Controls (Sheet 2 of 2)

## SECTION 2 LIMITATIONS

There is no change to the airplane limitations when this avionic equipment is installed.

## SECTION 3 EMERGENCY PROCEDURES

TO TRANSMIT AN EMERGENCY SIGNAL:

- (1) Function Switch -- ON.
- (2) Reply-Code Selector Switches -- SELECT 7700 operating code.
- (3) ID Switch -- DEPRESS then RELEASE to effect immediate identification of aircraft on ground controller's display.

TO TRANSMIT A SIGNAL REPRESENTING LOSS OF ALL COMMUNICATIONS (WHEN IN A CONTROLLED ENVIRONMENT):

- (1) Function Switch -- ON.
- (2) Reply-Code Selector Switches -- SELECT 7700 operating code for 1 minute; then SELECT 7600 operating code for 15 minutes and then REPEAT this procedure at same intervals for remainder of flight.
- (3) ID Switch -- DEPRESS then RELEASE at intervals to effect immediate identification of aircraft on ground controller's display.

## SECTION 4 NORMAL PROCEDURES

BEFORE TAKEOFF:

- (1) Function Switch -- SBY.

TO TRANSMIT MODE A (AIRCRAFT IDENTIFICATION) CODES IN FLIGHT:

- (1) Reply-Code Selector Switches -- SELECT assigned code.

- (2) Function Switch -- ON.
- (3) DIM Control -- ADJUST light brilliance of reply lamp.

NOTE

During normal operation with function switch in ON position, REPLY lamp flashes indicating transponder replies to interrogations.

- (4) ID Button -- DEPRESS momentarily when instructed by ground controller to "squawk IDENT" (REPLY lamp will glow steadily, indicating IDENT operation).

TO TRANSMIT MODE C (ALTITUDE REPORTING) CODES IN FLIGHT:

- (1) Off Indicator Warning Flag -- VERIFY that flag is out of view on encoding altimeter.
- (2) Altitude Encoder Altimeter Setting Knob - SET IN assigned local altimeter setting.
- (3) Reply-Code Selector Switches -- SELECT assigned code.
- (4) Function Switch -- ALT.

NOTE

When directed by ground controller to "stop altitude squawk", turn Function Switch to ON for Mode A operation only.

NOTE

Pressure altitude is transmitted by the transponder for altitude squawk and conversion to indicated altitude is done in ATC computers. Altitude squawked will only agree with indicated altitude when the local altimeter setting in use by the ground controller is set in the encoding altimeter.

- (5) DIM Control -- ADJUST light brilliance of reply lamp.

TO SELF-TEST TRANSPONDER OPERATION:

- (1) Function Switch -- SBY and wait 30 seconds for equipment to warm-up.

- (2) Function Switch -- ON or ALT.
- (3) TEST Button -- DEPRESS and HOLD (Reply lamp should light with full brilliance regardless of DIM control setting).
- (4) TEST Button -- RELEASE for normal operation.

## SECTION 5

### PERFORMANCE

There is no change to the airplane performance when this avionic equipment is installed. However, the installation of an externally mounted antenna or several related external antennas, will result in a minor reduction in cruise performance.

3. **IDENT (ID) SWITCH** - When depressed, selects special pulse identifier to be transmitted with transponder reply to effect immediate identification of aircraft on ground controller's display. (Reply lamp will glow steadily during duration of IDENT pulse transmission.)
4. **DIMMER (DIM) CONTROL** - Allows pilot to control brilliance of reply lamp.
5. **SELF-TEST (TEST) SWITCH** - When depressed, causes transponder to generate a self-interrogating signal to provide a check of transponder operation. (Reply lamp will glow steadily to verify self-test operation.)
6. **REPLY-CODE SELECTOR SWITCHES (4)** - Select assigned Mode A reply code.
7. **REPLY-CODE INDICATORS (4)** - Display selected Mode A reply code.
8. **REMOTE-MOUNTED DIGITIZER** - Provides an altitude reporting code range of -1000 feet up to the airplane's maximum service ceiling.

Figure 1. Cessna 400 Transponder and Altitude Encoder (Blind)  
(Sheet 2 of 2)

## SECTION 2 LIMITATIONS

There is no change to the airplane limitations when this avionic equipment is installed. However, a placard labeled "ALTITUDE ENCODER EQUIPPED" must be installed near the altimeter.

## SECTION 3 EMERGENCY PROCEDURES

TO TRANSMIT AN EMERGENCY SIGNAL:

- (1) Function Switch -- ON.
- (2) Reply-Code Selector Switches -- SELECT 7700 operating code.
- (3) ID Switch -- DEPRESS then RELEASE to effect immediate identification of aircraft on ground controller's display.

TO TRANSMIT A SIGNAL REPRESENTING LOSS OF ALL COMMUNICATIONS (WHEN IN A CONTROLLED ENVIRONMENT):

- (1) Function Switch -- ON.
- (2) Reply-Code Selector Switches -- SELECT 7700 operating code for 1 minute; then SELECT 7600 operating code for 15 minutes and then REPEAT this procedure at same intervals for remainder of flight.
- (3) ID Switch -- DEPRESS then RELEASE at intervals to effect immediate identification of aircraft on ground controller's display.

## SECTION 4 NORMAL PROCEDURES

BEFORE TAKEOFF:

- (1) Function Switch -- SBY.

TO TRANSMIT MODE A (AIRCRAFT IDENTIFICATION) CODES IN FLIGHT:

- (1) Reply-Code Selector Switches -- SELECT assigned code.

- (2) Function Switch -- ON.
- (3) DIM Control -- ADJUST light brilliance of reply lamp.

NOTE

During normal operation with function switch in ON position, reply lamp flashes indicating transponder replies to interrogations.

- (4) ID Button -- DEPRESS momentarily when instructed by ground controller to "squawk IDENT" (reply lamp will glow steadily, indicating IDENT operation).

TO TRANSMIT MODE C (ALTITUDE REPORTING) CODES IN FLIGHT:

- (1) Reply-Code Selector Switches -- SELECT assigned code.
- (2) Function Switch -- ALT.

NOTE

When directed by ground controller to "stop altitude squawk", turn Function Switch to ON for Mode A operation only.

NOTE

Pressure altitude is transmitted by the transponder for altitude squawk and conversion to indicated altitude is done in ATC computers. Altitude squawked will only agree with indicated altitude when the local altimeter setting in use by the ground controller is set in the aircraft altimeter.

- (3) DIM Control -- ADJUST light brilliance of reply lamp.

TO SELF-TEST TRANSPONDER OPERATION:

- (1) Function Switch -- SBY and wait 30 seconds for equipment to warm-up.
- (2) Function Switch -- ON.
- (3) TEST Button -- DEPRESS (reply lamp should light brightly regardless of DIM control setting).
- (4) TEST Button -- RELEASE for normal operation.

## SECTION 5 PERFORMANCE

There is no change to the airplane performance when this avionic equipment is installed. However, the installation of an externally mounted antenna or several related external antennas, will result in a minor reduction in cruise performance.



# **SUPPLEMENT**

## **CESSNA 400 GLIDE SLOPE**

### **(Type R-443B)**

#### **SECTION 1**

#### **GENERAL**

The Cessna 400 Glide Slope is an airborne navigation receiver which receives and interprets glide slope signals from a ground-based Instrument Landing System (ILS). It is used with the localizer function of a VHF navigation system when making instrument approaches to an airport. The glide slope provides vertical path guidance while the localizer provides horizontal track guidance.

The Cessna 400 Glide Slope system consists of a remote-mounted receiver coupled to an existing navigation system, a panel-mounted indicator and an externally-mounted antenna. The glide slope receiver is designed to receive ILS glide slope signals on any of 40 channels. The channels are spaced 150 kHz apart and cover a frequency range of 329.15 MHz through 335.0 MHz. When a localizer frequency is selected on the NAV receiver, the associated glide slope frequency is selected automatically.

Operation of the Cessna 400 Glide Slope system is controlled by the associated navigation system. The functions and indications of typical 300 series glide slope indicators are pictured and described in Figure 1. The 300 series glide slope indicators shown in Figure 1 depict typical indications for all Cessna-crafted glide slope indicators. However, refer to the 400 Nav/Com or HSI write-ups if they are listed in this section as options for additional glide slope indicators.

#### **SECTION 2**

#### **LIMITATIONS**

There is no change to the airplane limitations when this avionic equipment is installed. However, the pilot should be aware that on many Cessna airplanes equipped with the windshield mounted glide slope antenna, pilots should avoid use of 2700  $\pm$ 100 RPM on airplanes equipped with a two-bladed propeller or 1800  $\pm$ 100 RPM on airplanes equipped with a three-bladed propeller during ILS approaches to avoid oscillations of the glide slope deviation pointer caused by propeller interference.

TYPICAL 300 SERIES GLIDE SLOPE INDICATORS

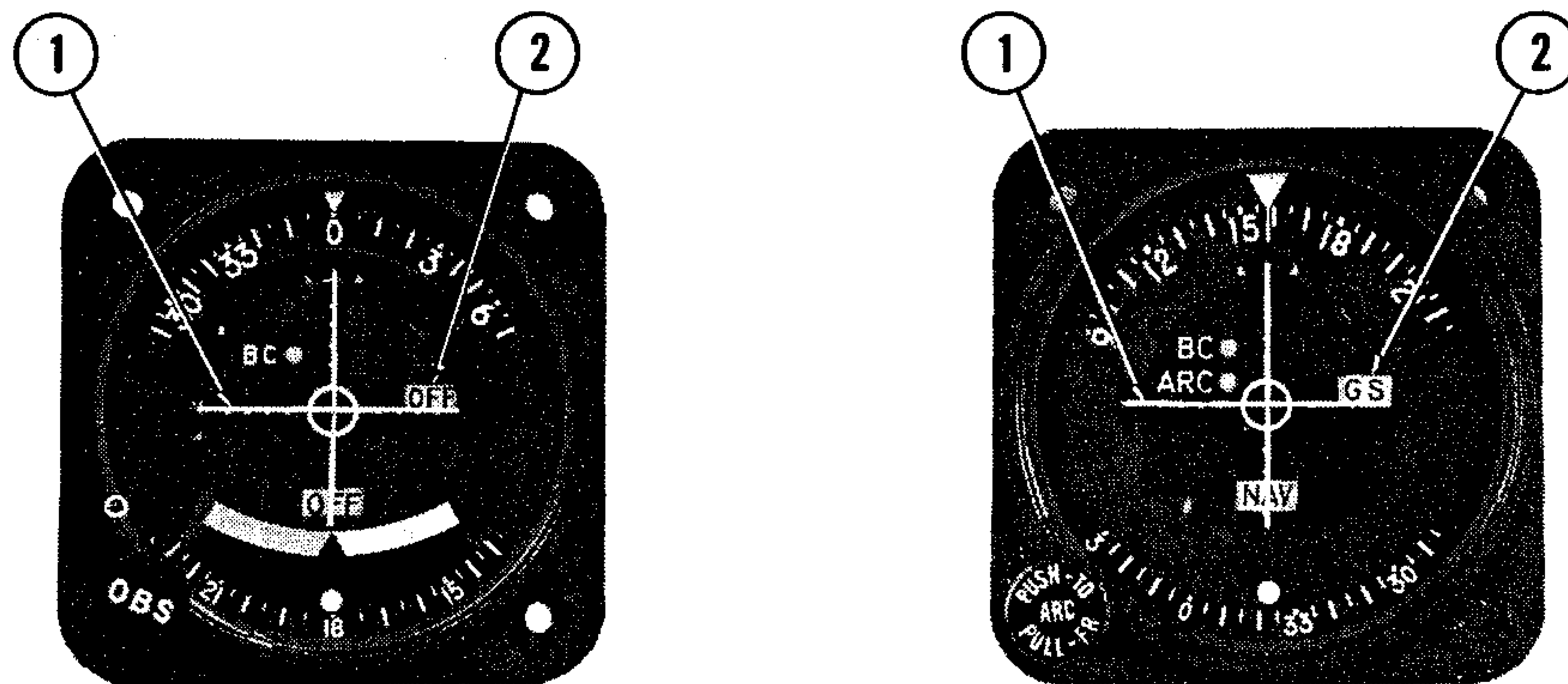

1. GLIDE SLOPE DEVIATION POINTER - Indicates deviation from normal glide slope.
2. GLIDE SLOPE "OFF" OR "GS" FLAG - When visible, indicates unreliable glide slope signal or improperly operating equipment. The flag disappears when a reliable glide slope signal is being received.

**CAUTION**

Spurious glide slope signals may exist in the area of the localizer back course approach which can cause the glide slope "OFF" or "GS" flag to disappear and present unreliable glide slope information. Disregard all glide slope signal indications when making a localizer back course approach unless a glide slope (ILS BC) is specified on the approach and landing chart.

Figure 1. Typical 300 Series VOR/LOC/ILS Indicator

### SECTION 3

## EMERGENCY PROCEDURES

There is no change to the airplane emergency procedures when this avionic equipment is installed.

### SECTION 4

## NORMAL PROCEDURES

TO RECEIVE GLIDE SLOPE SIGNALS:

- (1) NAV Frequency Select Knobs -- SELECT desired localizer frequency (glide slope frequency is automatically selected).
- (2) NAV/COM VOX-ID-T Switch -- SELECT ID position to disconnect filter from audio circuit.
- (3) NAV VOL Control -- ADJUST to desired listening level to confirm proper localizer station.

### **CAUTION**

When glide slope "OFF" or "GS" flag is visible, glide slope indications are unusable.

### SECTION 5

## PERFORMANCE

There is no change to the airplane performance when this avionic equipment is installed.



# **SUPPLEMENT**

## **OPTIONAL UNSLAVED HORIZONTAL SITUATION INDICATOR (HSI) (TYPE IG-832C)**

### **SECTION 1 GENERAL**

The IG-832C Horizontal Situation Indicator (HSI) is an additional navigation indicator option which provides a heading reference with respect to an unslaved directional gyro, a heading reference bug, VOR course selection, and a pictorial presentation of the airplane position relative to VOR and localizer courses and glide slopes. This indicator is used with Cessna 300 and 400 Nav/Com radios. When dual Nav/Com radios are installed, the HSI is coupled to the number 1 NAV/COM and a standard 300 or 400 series VOR/LOC course deviation indicator is coupled to the number 2 NAV/COM.

This system consists of a Horizontal Situation Indicator (HSI-Type IG-832C) and a remote mounted VOR/LOC Converter (Type B-445A). The indicator is unslaved and course datum is not available. When the HSI is installed with a 300A, 400A or 400B Autopilot system, a BC light is installed on the instrument panel, adjacent to the HSI, to alert the pilot of back-course operation. Each control and indicator function is described in Figure 1.

### **SECTION 2 LIMITATIONS**

There is no change to the airplane limitations when this instrument is installed.

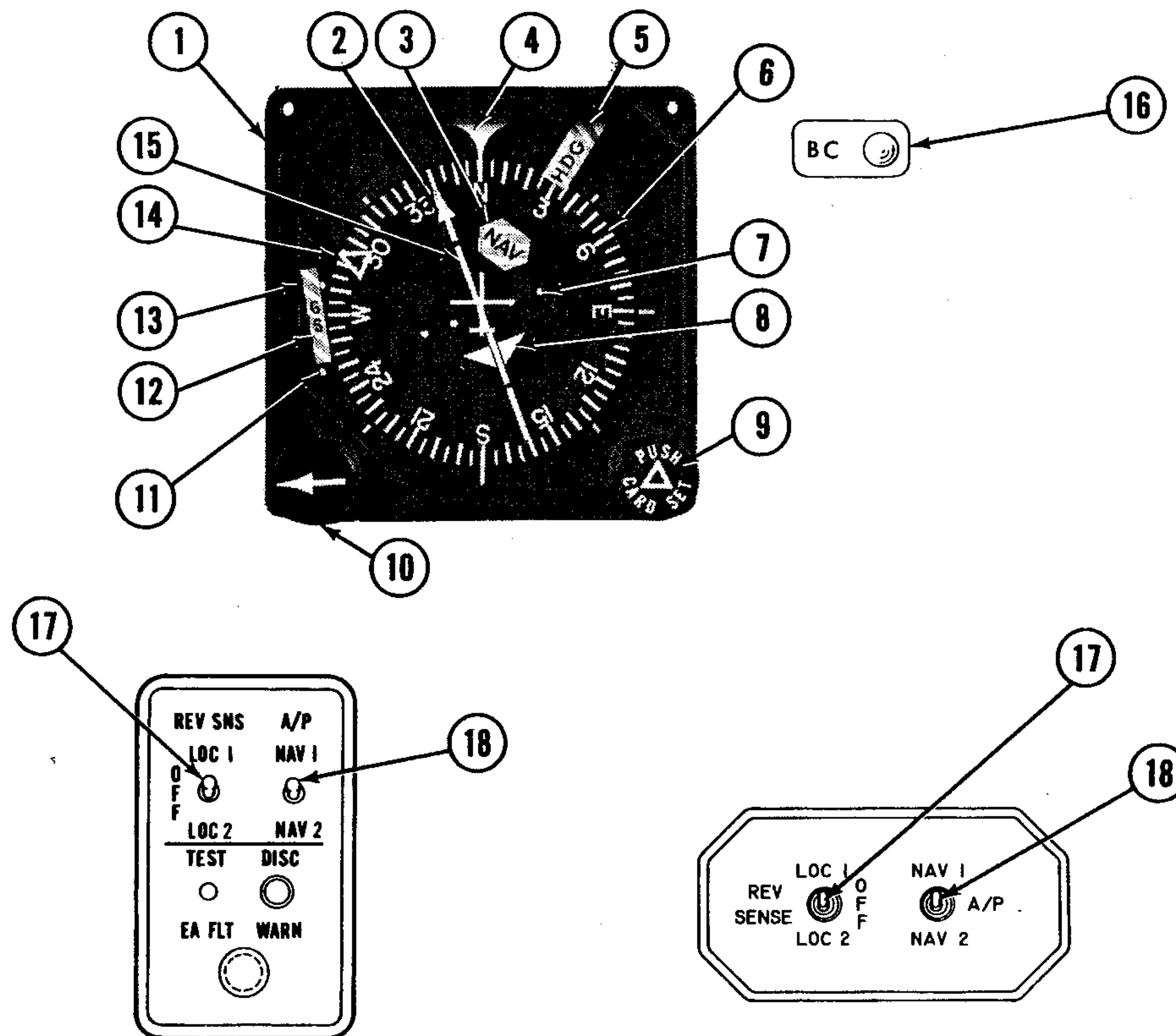

USED WITH 400B AUTOPILOT  
ON 210 SERIES MODELS

USED WITH 400A AUTOPILOT  
ON 337 SERIES MODELS

1. HORIZONTAL SITUATION INDICATOR (HSI) - Provides a pictorial presentation of aircraft deviation relative to VOR radials and localizer beams. It also displays glide slope deviations and gives heading reference with respect to magnetic north when compass card is set to agree with compass.
2. OMNI BEARING POINTER - Indicates selected VOR course or localizer course on compass card (6). The selected VOR radial or localizer heading remains set on the compass card when the compass card (6) is rotated.
3. NAV FLAG - When flag is in view, indicates that the NAV receiver signal being received is not reliable.

Figure 1. Horizontal Situation Indicator (HSI) (Type IG-832C)  
(Sheet 1 of 3)

4. **HEADING REFERENCE (LUBBER LINE)** - Indicates aircraft magnetic heading on compass card (6).
5. **HEADING WARNING FLAG (HDG)** - When flag is in view, heading display is invalid due to the heading system power being interrupted or the HSI vacuum powered gyro being low.
6. **COMPASS CARD** - Rotates to display heading of airplane with reference to lubber line (4). Must be set to agree with aircraft compass using Card Set Knob (9).
7. **COURSE DEVIATION DOTS** - Indicates aircraft displacement from VOR, or localizer beam center. A full scale (2 dots) course deviation bar (15) displacement represents the following deviations from beam center:
  - a. VOR =  $\pm 10^\circ$  approx.
  - b. LOC =  $\pm 2-1/2^\circ$  approx.
8. **TO/FROM INDICATOR FLAG** - Indicates direction of VOR station relative to selected course.
9. **HEADING SELECTOR AND CARD SET KNOB (PUSH ▲ CARD SET)** - When rotated in normal (out) position, positions heading "bug" (14) on compass card (6) to indicate selected heading for reference or for autopilot tracking. When pushed in and rotated, sets compass card (6) to agree with magnetic compass. The omni bearing pointer (2), heading bug (14), and deviation bar (15) rotate with the compass card (6).

NOTE

The compass card (6) must be reset periodically to compensate for precessional errors in the gyro.

10. **COURSE SELECTOR (↓) KNOB** - When rotated, positions omni bearing pointer (2) on the compass card (6) to select desired VOR radial or localizer course.
11. **GLIDE SLOPE SCALE** - Indicates displacement from glide slope beam center. A glide slope deviation bar displacement of 2 dots, represents full scale ( $0.7^\circ$ ) deviation above or below glide slope beam centerline.
12. **GLIDE SLOPE POINTER** - Indicates on glide slope scale (11) aircraft displacement from glide slope beam center.
13. **GLIDE SLOPE FLAG** - When in view, indicates glide slope receiver signal is not reliable.
14. **HEADING BUG** - Indicates selected reference heading relative to compass card (6).
15. **COURSE (OMNI) DEVIATION BAR** - Bar is center portion of omni bearing pointer and moves laterally to pictorially indicate relationship of aircraft to selected course. It relates in degrees of angular displacement from VOR radials or localizer beam center (see Item 7).

Figure 1. Horizontal Situation Indicator (HSI) (Type IG-832C)  
(Sheet 2 of 3)

16. BACK-COURSE LIGHT (BC) (Installed in a remote position, as shown, with 300A, 400A and 400B autopilots only.) - The remote amber BC light will illuminate when back-course operation is selected by the REV SNS LOC 1 switch (17) mounted on the left-hand instrument panel or the BC function of 300A autopilot.

**CAUTION**

When back-course operation is selected, the course (omni) deviation bar (15) on the HSI does not reverse. However, selection of back-course operation will always cause the localizer signal to the autopilot to reverse for back-course operation.

17. BACK COURSE REVERSE SENSE (REV SNS) LOC 1 OR LOC 2 SELECTOR SWITCH - With AP switch ON (on 400A or 400B Autopilot control units) and either LOC 1 or LOC 2 selected, localizer signals to the Cessna 400A or 400B Autopilots will reverse for back-course operation. With autopilot ON or OFF, the course (omni) deviation bar on the HSI will not reverse but the standard CDI pointer will reverse depending on the position of the REV SNS switch.
18. AUTOPILOT (A/P) NAV 1 OR NAV 2 SELECTOR SWITCH - (Installed with 400A and 400B Autopilots only) Selects appropriate signals from the desired navigation receiver to be coupled to the autopilot.

Figure 1. Horizontal Situation Indicator (HSI) (Type IG-832C)  
(Sheet 3 of 3)



## SECTION 3 EMERGENCY PROCEDURES

There is no change to the airplane emergency procedures when this instrument is installed.

## SECTION 4 NORMAL PROCEDURES

Normal procedures for operation of this system differ little from those required for the more conventional Course Deviation Indicators. However, several small differences are worth noting.

The rectilinear movement of the omni deviation bar in combination with the rotation of the compass card in response to heading changes, provides an intuitive picture of the navigation situation at a glance when turned to an omni station. When tuned to a localizer frequency, the omni bearing pointer must be set to the inboard front course for both front and back-course approaches to retain this pictorial presentation.

When the HSI system is installed with a Cessna 300A (Type AF-395A), Cessna 400A (Type AF-530A) or Cessna 400B (Type IF-550A) Autopilot, a back-course indicator light labeled BC, is mounted adjacent to the HSI and will illuminate amber when the reverse sense (REV SNS) switch (mounted in the upper portion of the pilot's instrument panel on 337 Models or is mounted in the autopilot's accessory unit on 210 Models) is placed in the ON (LOC 1) position to alert the pilot that back-course operation is selected. The HSI needle will not be reversed but the LOC signals to the autopilot will be. Light dimming for the BC light is provided for low ambient light conditions.

For normal procedures with autopilots, refer to the 300A, 400A and 400B Autopilot Supplements in this handbook if they are listed in this section as options.

## SECTION 5 PERFORMANCE

There is no change to the airplane performance when this instrument is installed.



# SUPPLEMENT

## CESSNA NAVOMATIC 200A AUTOPILOT (Type AF-295B)

### SECTION 1 GENERAL

The Cessna 200A Navomatic is an all electric, single-axis (aileron control) autopilot system that provides added lateral and directional stability. Components are a computer-amplifier, a turn coordinator, an aileron actuator, and a course deviation indicator(s) incorporating a localizer reversed (BC) indicator light

Roll and yaw motions of the airplane are sensed by the turn coordinator gyro. The computer-amplifier electronically computes the necessary correction and signals the actuator to move the ailerons to maintain the airplane in the commanded lateral attitude.

The 200A Navomatic will also capture and track a VOR or localizer course using signals from a VHF navigation receiver.

The operating controls for the Cessna 200A Navomatic are located on the front panel of the computer-amplifier, shown in Figure 1. The primary function pushbuttons (DIR HOLD, NAV CAPT, and NAV TRK), are interlocked so that only one function can be selected at a time. The HI SENS and BACK CRS pushbuttons are not interlocked so that either or both of these functions can be selected at any time.

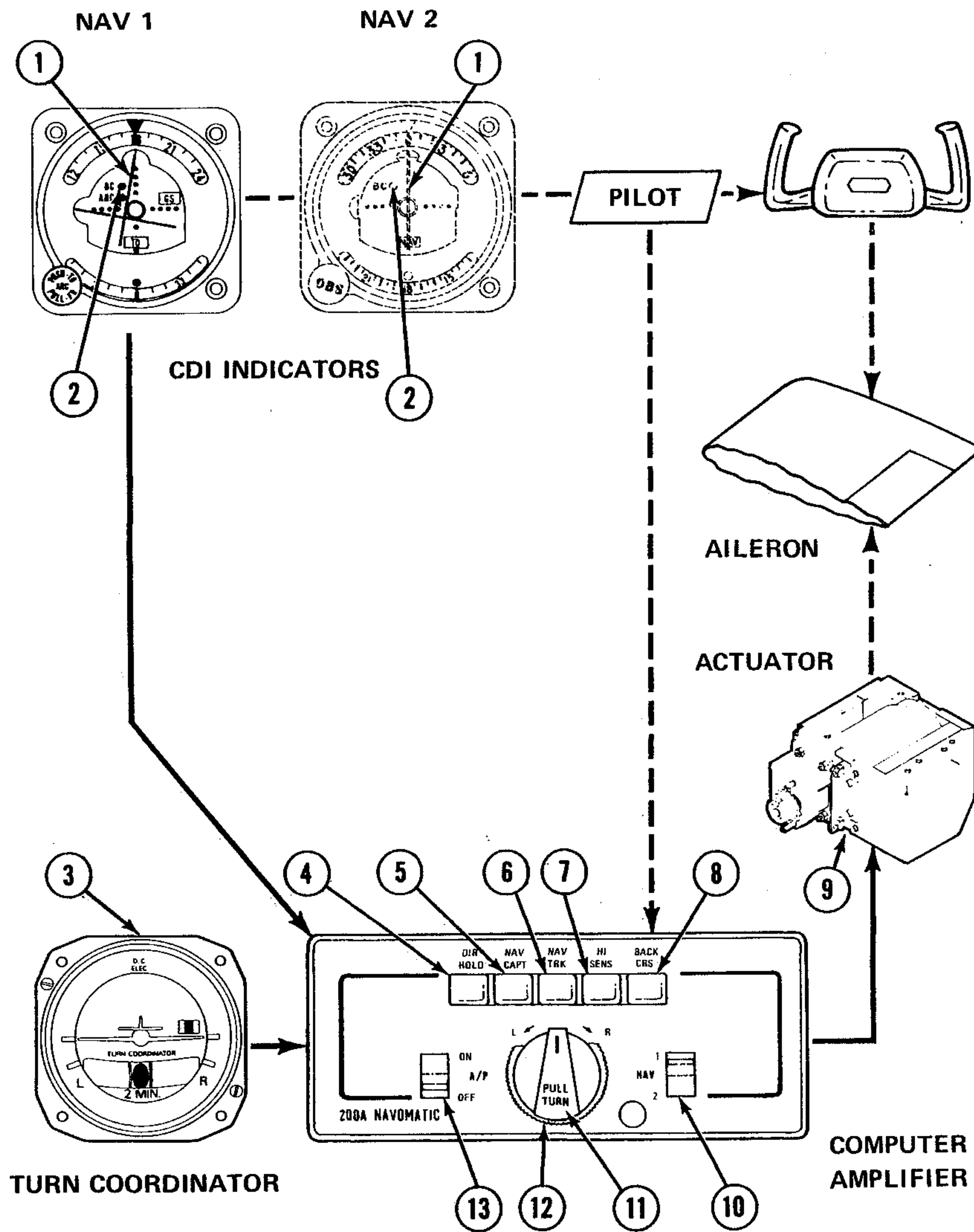

Figure 1. Cessna 200A Autopilot, Operating Controls and Indicators  
(Sheet 1 of 2)

1. COURSE DEVIATION INDICATOR - Provides VOR/LOC navigation inputs to autopilot for intercept and tracking modes.
2. LOCALIZER REVERSED INDICATOR LIGHT - Amber light, labeled BC, illuminates when BACK CRS button is pushed in (engaged) and LOC frequency selected. BC light indicates course indicator needle is reversed on selected receiver (when turned to a localizer frequency). This light is located within the CDI indicator.
3. TURN COORDINATOR - Senses roll and yaw for wings leveling and command turn functions.
4. DIR HOLD PUSHBUTTON - Selects direction hold mode. Airplane holds direction it is flying at time button is pushed.
5. NAV CAPT PUSHBUTTON - Selects NAV capture mode. When parallel to desired course, the airplane will turn to a pre-described intercept angle and capture selected VOR or LOC course.
6. NAV TRK PUSHBUTTON - Selects NAV track mode. Airplane tracks selected VOR or LOC course.
7. HI SENS PUSHBUTTON - During NAV CAPT or NAV TRK operation, this high sensitivity setting increases autopilot response to NAV signal to provide more precise operation during localizer approach. In low sensitivity position (pushbutton out), response to NAV signal is dampened for smoother tracking of enroute VOR radials; it also smooths out effect of course scalloping during NAV operation.
8. BACK CRS PUSHBUTTON - Used with LOC operation only. With A/P switch OFF or ON, and when navigation receiver selected by NAV switch is set to a localizer frequency, it reverses normal localizer needle indication (CDI) and causes localizer reversed (BC) light to illuminate. With A/P switch ON, reverses localizer signal to autopilot.
9. ACTUATOR - The torque motor in the actuator causes the ailerons to move in the commanded direction.
10. NAV SWITCH - Selects NAV 1 or NAV 2 navigation receiver.
11. PULL TURN KNOB - When pulled out and centered in detent, airplane will fly wings-level; when turned to the right (R), the airplane will execute a right, standard rate turn; when turned to the left (L), the airplane will execute a left, standard rate turn. When centered in detent and pushed in, the operating mode selected by a pushbutton is engaged.
12. TRIM - Used to trim autopilot to compensate for minor variations in aircraft trim or weight distribution. (For proper operation, the aircraft's rudder trim, if so equipped, must be manually trimmed before the autopilot is engaged.)
13. A/P SWITCH - Turns autopilot ON or OFF.

Figure 1. Cessna 200A Autopilot, Operating Controls and Indicators  
(Sheet 2 of 2)

## SECTION 2 LIMITATIONS

There is no change to the airplane limitations when this avionic equipment is installed. However, the following autopilot limitation should be adhered to during airplane operation:

BEFORE TAKE-OFF AND LANDING:

1. A/P ON-OFF Switch -- OFF.

## SECTION 3 EMERGENCY PROCEDURES

TO OVERRIDE THE AUTOPILOT:

1. Airplane Control Wheel -- ROTATE as required to override autopilot.

### NOTE

The servo may be overpowered at anytime without damage.

TO TURN OFF AUTOPILOT:

1. A/P ON-OFF Switch -- OFF.

## SECTION 4 NORMAL PROCEDURES

BEFORE TAKE-OFF AND LANDING:

1. A/P ON-OFF Switch -- OFF.
2. BACK CRS Button -- OFF (see Caution note under Nav Capture).

### NOTE

Periodically verify operation of amber warning light(s), labeled BC on CDI(s), by engaging BACK CRS button with a LOC frequency selected.

**INFLIGHT WINGS LEVELING:**

1. Airplane Rudder Trim -- ADJUST for zero slip ("Ball" centered on Turn Coordinator).
2. PULL-TURN Knob -- CENTER and PULL out.
3. A/P ON-OFF Switch -- ON.
4. Autopilot TRIM Control -- ADJUST for zero turn rate (wings level indication on Turn Coordinator).

**NOTE**

For optimum performance in airplanes equipped as float-planes, use autopilot only in cruise flight or in approach configuration with flaps down no more than 10° and airspeed no lower than 75 KIAS on 172 and R172 Series Models or 85 KIAS on 180, 185, U206 and TU206 Series Models.

**COMMAND TURNS:**

1. PULL-TURN Knob -- CENTER, PULL out and ROTATE.

**DIRECTION HOLD:**

1. PULL-TURN Knob -- CENTER and PULL out.
2. Autopilot TRIM Control -- ADJUST for zero turn rate.
3. Airplane Rudder Trim -- ADJUST for zero slip ("Ball" centered).
4. DIR HOLD Button -- PUSH.
5. PULL-TURN Knob -- PUSH in detent position when airplane is on desired heading.
6. Autopilot TRIM Control -- READJUST for zero turn rate.

**NAV CAPTURE (VOR/LOC):**

1. PULL-TURN Knob -- CENTER and PULL out.
2. NAV 1-2 Selector Switch -- SELECT desired VOR receiver.
3. Nav Receiver OBS or ARC Knob -- SET desired VOR course (if tracking omni).

**NOTE**

Optional ARC knob should be in center position and ARC amber warning light should be off.

4. NAV CAPT Button -- PUSH.
5. HI SENS Button -- PUSH for localizer and "close-in" omni intercepts.

6. BACK CRS Button -- PUSH only if intercepting localizer front course outbound or back course inbound.

### CAUTION

With BACK CRS button pushed in and localizer frequency selected, the CDI on selected nav radio will be reversed even when the autopilot switch is OFF.

7. PULL-TURN Knob -- Turn airplane parallel to desired course.

#### NOTE

Airplane must be turned until heading is within  $\pm 5^\circ$  of desired course.

8. PULL TURN Knob -- CENTER and PUSH in. The airplane should then turn toward desired course at  $45^\circ \pm 10^\circ$  intercept angle (if the CDI needle is in full deflection).

#### NOTE

If more than 15 miles from the station or more than 3 minutes from intercept, use a manual intercept procedure.

#### NAV TRACKING (VOR/LOC):

1. NAV TRK Button -- PUSH when CDI centers and airplane is within  $\pm 5^\circ$  of course heading.
2. HI SENS BUTTON -- DISENGAGE for enroute omni tracking (leave ENGAGED for localizer).
3. Autopilot TRIM Control -- READJUST as required to maintain track.

#### NOTE

Optional ARC function, if installed, should not be used for autopilot operation. If airplane should deviate off course, pull out PULL TURN knob and readjust airplane rudder trim for straight flight on the Turn Coordinator. Push in PULL TURN knob to reintercept course. If deviation persists, progressively make slight adjustments of autopilot TRIM control towards the course as required to maintain track.

## SECTION 5 PERFORMANCE

There is no change to the airplane performance when this avionics equipment is installed.



## SUPPLEMENT

# CESSNA NAVOMATIC 300A AUTOPILOT (Type AF-395A)

## SECTION 1 GENERAL

The Cessna 300A Navomatic is an all electric, single-axis (aileron control) autopilot system that provides added lateral and directional stability. Components are a computer-amplifier, a turn coordinator, a directional gyro, an aileron actuator and a course deviation indicator(s) incorporating a localizer reversed (BC) indicator light.

Roll and yaw motions of the airplane are sensed by the turn coordinator gyro. Deviations from the selected heading are sensed by the directional gyro. The computer-amplifier electronically computes the necessary correction and signals the actuator to move the ailerons to maintain the airplane in the commanded lateral attitude or heading.

The 300A Navomatic will also intercept and track a VOR or localizer course using signals from a VHF navigation receiver.

The operating controls for the Cessna 300A Navomatic are located on the front panel of the computer-amplifier and on the directional gyro, shown in Figure 1. The primary function pushbuttons (HDG SEL, NAV INT, and NAV TRK), are interlocked so that only one function can be selected at a time. The HI SENS and BACK CRS pushbuttons are not interlocked so that either or both of these functions can be selected at any time.

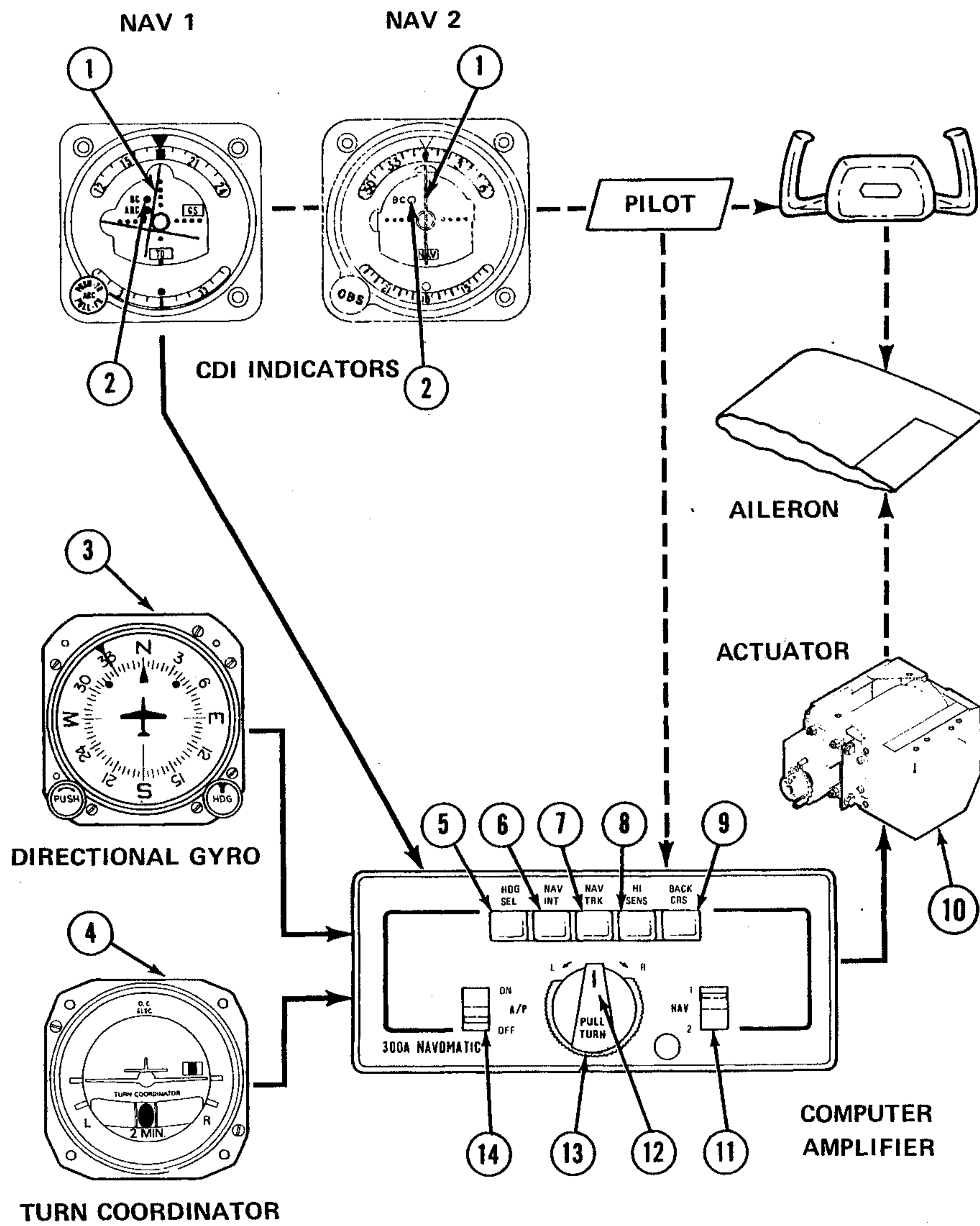

Figure 1. Cessna 300A Autopilot, Operating Controls and Indicators  
(Sheet 1 of 2)

1. COURSE DEVIATION INDICATOR - Provides VOR/LOC navigation inputs to autopilot for intercept and tracking modes.
2. LOCALIZER REVERSED INDICATOR LIGHT - Amber light, labeled BC, illuminates when BACK CRS button is pushed in (engaged) and LOC frequency selected. BC light indicates course indicator needle is reversed on selected receiver (when tuned to a localizer frequency). This light is located within the CDI indicator.
3. DIRECTIONAL GYRO INDICATOR - Provides heading information to the autopilot for heading intercept and hold. Heading bug on indicator is used to select desired heading or VOR/LOC course to be flown.
4. TURN COORDINATOR - Senses roll and yaw for wings leveling and command turn functions.
5. HDG SEL PUSHBUTTON - Aircraft will turn to and hold heading selected by the heading "bug" on the directional gyro.
6. NAV INT PUSHBUTTON - When heading "bug" on DG is set to selected course, aircraft will turn to and intercept selected VOR or LOC course.
7. NAV TRK PUSHBUTTON - When heading "bug" on DG is set to selected course, aircraft will track selected VOR or LOC course.
8. HI SENS PUSHBUTTON - During NAV INT or NAV TRK operation, this high sensitivity setting increases autopilot response to NAV signal to provide more precise operation during localizer approach. In low-sensitivity position (pushbutton out), response to NAV signal is dampened for smoother tracking of enroute VOR radials; it also smooths out effect of course scalloping during NAV operation.
9. BACK CRS PUSHBUTTON - Used with LOC operation only. With A/P switch OFF or ON, and when navigation receiver selected by NAV switch is set to a localizer frequency, it reverses normal localizer needle indication (CDI) and causes localizer reversed (BC) light to illuminate. With A/P switch ON, reverses localizer signal to autopilot.
10. ACTUATOR - The torque motor in the actuator causes the ailerons to move in the commanded direction.
11. NAV SWITCH - Selects NAV 1 or NAV 2 navigation receiver.
12. PULL TURN KNOB - When pulled out and centered in detent, airplane will fly wings-level; when turned to the right (R), the airplane will execute a right, standard rate turn; when turned to the left (L), the airplane will execute a left, standard rate turn. When centered in detent and pushed in, the operating mode selected by a pushbutton is engaged.
13. TRIM - Used to trim autopilot to compensate for minor variations in aircraft trim or lateral weight distribution. (For proper operation, the aircraft's rudder trim, if so equipped, must be manually trimmed before the autopilot is engaged.
14. A/P SWITCH - Turns autopilot ON or OFF.

Figure 1. Cessna 300A Autopilot, Operating Controls and Indicators  
(Sheet 2 of 2)

## SECTION 2 LIMITATIONS

There is no change to the airplane limitations when this avionic equipment is installed. However, the following autopilot limitation should be adhered to during airplane operation:

BEFORE TAKE-OFF AND LANDING:

1. A/P ON-OFF Switch -- OFF.

## SECTION 3 EMERGENCY PROCEDURES

TO OVERRIDE THE AUTOPILOT:

1. Airplane Control Wheel -- ROTATE as required to override autopilot.

### NOTE

The servo may be overpowered at any time without damage.

TO TURN OFF AUTOPILOT:

1. A/P ON-OFF Switch -- OFF.

## SECTION 4 NORMAL PROCEDURES

BEFORE TAKE-OFF AND LANDING:

1. A/P ON-OFF Switch -- OFF.
2. BACK CRS Button -- OFF (see Caution note under Nav Intercept).

### NOTE

Periodically verify operation of amber warning light(s), labeled BC on CDI(s), by engaging BACK CRS button with a LOC frequency selected.

**INFLIGHT WINGS LEVELING:**

1. Airplane Rudder Trim -- ADJUST for zero slip ("Ball" centered on Turn Coordinator).
2. PULL-TURN Knob -- CENTER and PULL out.
3. A/P ON-OFF Switch -- ON.
4. Autopilot TRIM Control -- ADJUST for zero turn rate (wings level indication on Turn Coordinator).

**NOTE**

For optimum performance in airplanes equipped as float-planes, use autopilot only in cruise flight or in approach configuration with flaps down no more than 10° and airspeed no lower than 75 KIAS on 172 and R172 Series Models or 85 KIAS on 180, 185, U206 and TU206 Series Models.

**COMMAND TURNS:**

1. PULL-TURN Knob -- CENTER, PULL out and ROTATE.

**HEADING SELECT:**

1. Directional Gyro -- SET to airplane magnetic heading.
2. Heading Selector Knob -- ROTATE bug to desired heading.
3. Heading Select Button -- PUSH.
4. PULL-TURN Knob -- CENTER and PUSH.

**NOTE**

Airplane will turn automatically to selected heading. If airplane fails to hold the precise heading, readjust autopilot TRIM control as required or disengage autopilot and reset manual rudder trim (if installed).

**NAV INTERCEPT (VOR/LOC):**

1. PULL-TURN Knob -- CENTER and PULL out.
2. NAV 1-2 Selector Switch -- SELECT desired receiver.
3. Nav Receiver OBS or ARC Knob -- SET desired VOR course (if tracking omni).

**NOTE**

Optional ARC knob should be in center position and ARC warning light should be off.

4. Heading Selector Knob -- ROTATE bug to selected course (VOR or localizer - inbound or outbound as appropriate).
5. Directional Gyro -- SET for magnetic heading.
6. NAV INT Button -- PUSH.
7. HI SENS Button -- PUSH for localizer and "close-in" omni intercepts.
8. BACK CRS Button -- PUSH only if intercepting localizer front course outbound or back course inbound.

### CAUTION

With BACK CRS button pushed in and localizer frequency selected, the CDI on selected nav radio will be reversed even when the autopilot switch is OFF.

9. PULL-TURN Knob -- PUSH.

### NOTE

Airplane will automatically turn to a 45° intercept angle.

### NAV TRACKING (VOR/LOC):

1. NAV TRK Button -- PUSH when CDI centers (within one dot) and airplane is within  $\pm 10^\circ$  of course heading.
2. HI SENS Button -- Disengage for enroute omni tracking (leave engaged for localizer).

### NOTE

Optional ARC feature, if installed, should not be used for autopilot operation. If CDI remains steadily off center, readjust autopilot TRIM control as required to maintain track.

## SECTION 5 PERFORMANCE

There is no change to the airplane performance when this avionic equipment is installed.



# PIEDMONT HAWTHORNE

## WEIGHT AND BALANCE RECORD

ACFT. REG. # N9947C

SERIAL # R18200489

W. O. # S4960

DATE 10-Jun-03

WEIGHED BY \_\_\_\_\_

INSPECTED BY Rey Leitao

	SCALE READING	ARM	MOMENT
LEFT	<u>590.00</u>	<u>59.25</u>	34957.5
RIGHT	<u>630.00</u>	<u>59.25</u>	37327.5
NOSE	<u>730.00</u>	<u>-6.25</u>	-4562.5
TAIL	<u>          </u>	<u>          </u>	0
SUBTOTAL	<u>1950.00</u>	<u>34.73</u>	67722.5
ADD UNUSABLE FUEL (IF WEIGHED EMPTY)	<u>30.00</u>	<u>46.00</u>	1380.00
SUBTRACT USABLE FUEL (IF WEIGHED FULL)	<u>          </u>	<u>          </u>	<u>          </u>
TOTAL	<u>1980.00</u>	<u>34.90</u>	<u>69102.50</u>
GROSS WEIGHT	<u>3112.00</u>		
NEW EMPTY WEIGHT	<u>1980.00</u>		
USEFUL LOAD	<u>1132.00</u>		
NEW EMPTY WEIGHT C. G.	<u>34.9</u>		

~~SUPERSEDED~~  
 PIEDMONT HAWTHORNE AVIATION  
 CRS #PIQR321K W/O  
 DATE 3/25/04 SIGN James P. Leitao

Approved By  
Rey Leitao  
 Inspector for  
 Piedmont Hawthorne Aviation  
 Norfolk, Va.  
 FAA Repair Station PIQR321K  
 W.O.# S4960

Aircraft Reg #

N9947C

Aircraft Serial #

R18200489

Date last W&B

6/10/2003

Empty Weight

1980.00

Empty Weight CG

34.90

Moment

69102.50

NO 6458

# Piedmont Hawthorne

6101 Burton Station Rd.  
Norfolk, VA 23502

## Weight & Balance/Equipment List Revision

### REMOVED ITEMS:

DESCRIPTION	PART #	SERIAL #	WEIGHT	ARM	MOMENT
Flap Gap Seals	NA	NA	3.50	75.20	263.20
TOTALS			3.50		263.20

### INSTALLED ITEMS:

DESCRIPTION	PART #	SERIAL #	WEIGHT	ARM	MOMENT
TOTALS					

### NEW TOTALS

Empty Weight

1976.50

Empty Weight CG

34.83

Moment

68839.30

DATE

3/25/2004

BY:

CERT #

PIQR321K